

IAEA-TECDOC-1420

# ***Advances in radiation chemistry of polymers***

*Proceedings of a technical meeting held in  
Notre Dame, Indiana, USA  
13–17 September 2003*



**IAEA**

International Atomic Energy Agency

November 2004



IAEA-TECDOC-1420

# ***Advances in radiation chemistry of polymers***

*Proceedings of a technical meeting held in  
Notre Dame, Indiana, USA  
13–17 September 2003*



**IAEA**

International Atomic Energy Agency

November 2004

The originating Section of this publication in the IAEA was:

Industrial Applications and Chemistry Section  
International Atomic Energy Agency  
Wagramer Strasse 5  
P.O. Box 100  
A-1400 Vienna, Austria

ADVANCES IN RADIATION CHEMISTRY OF POLYMERS

IAEA, VIENNA, 2004

IAEA-TECDOC-1420

ISBN 92-0-112504-6

ISSN 1011-4289

© IAEA, 2004

Printed by the IAEA in Austria  
November 2004

## FOREWORD

Chemical reactions can be initiated by radiation at any temperature, under any pressure and in any phase (gas, liquid or solid) without the use of catalysts. The irradiation of polymeric materials with ionizing radiation (gamma rays, X rays, accelerated electrons, ion beams) leads to the formation of very reactive intermediates. These intermediates can follow several reaction paths, which result in rearrangements and/or formation of new bonds. The ultimate effects of these reactions can be the formation of oxidized products, grafts, scission of main chains (degradation) or cross-linking. The degree of these transformations depends on the structure of the polymer and the conditions of treatment before, during and after irradiation. Good control of all of these processing factors facilitates the modification of polymers by radiation processing.

This property of radiation processing was used early on for polymer modification. Nowadays, the modification of polymers covers radiation cross-linking, radiation induced polymerization (graft polymerization and curing) and the degradation of polymers. Likewise, medical products to be sterilized by radiation are often made from polymeric materials, which must be resistant to the administered dose.

Polymers are the materials most often treated by radiation. Therefore in the recent past the IAEA has organized Coordinated Research Projects (CRPs) in closely related areas, namely the stability and stabilization of polymers under irradiation, the radiation vulcanization of natural rubber latex, the modification of polymers for biomedical applications such as the radiation synthesis of membranes, hydrogels and adsorbents.

The CRP on The Stability and Stabilization of Polymers under Irradiation was organized from 1994 to 1997 (IAEA-TECDOC-1062). The participants began research into the production of polymers under preparation of blends, which should withstand irradiation through the course of their useful lifetimes. They concluded that much remains to be learned in terms of understanding degradation mechanisms and phenomena. The application of radiation for the preparation of polymers for biomedical applications was the subject of the CRP on Radiation Synthesis and Modification of Polymers for Biomedical Applications implemented from 1996 to 2000 (IAEA-TECDOC-1324).

The Technical Meeting on Emerging Applications of Radiation Processing for the 21st Century organized in Vienna in April 2003 reviewed the present status and developments in radiation technology and its applications and identified the main fields of research and development to be explored within the framework of the IAEA programmes (IAEA-TECDOC-1386). The topics of follow-up meetings will cover these issues in order to stimulate research and development in the most important and promising areas. The consultants meeting on Advances in Radiation Chemistry of Polymers held at the University of Notre Dame, USA in September 2003 was the first in this series. The new developments concerning polymer processing were reported and the status of the technology was reviewed during the meeting.

The IAEA wishes to thank all the participants for their valuable contributions. The IAEA officer responsible for this publication was A.G. Chmielewski of the Division of Physical and Chemical Sciences.

## *EDITORIAL NOTE*

*This publication has been prepared from the original material as submitted by the authors. The views expressed do not necessarily reflect those of the IAEA, the governments of the nominating Member States or the nominating organizations.*

*The use of particular designations of countries or territories does not imply any judgement by the publisher, the IAEA, as to the legal status of such countries or territories, of their authorities and institutions or of the delimitation of their boundaries.*

*The mention of names of specific companies or products (whether or not indicated as registered) does not imply any intention to infringe proprietary rights, nor should it be construed as an endorsement or recommendation on the part of the IAEA.*

*The authors are responsible for having obtained the necessary permission for the IAEA to reproduce, translate or use material from sources already protected by copyrights.*

## CONTENTS

SUMMARY .....	1
Basics of radiation chemistry in the real world: nanoparticles in aqueous suspensions .....	5
<i>D. Meisel</i>	
Hydrogen generation in transuranic waste storage containers .....	15
<i>J. La Verne</i>	
Radiation chemistry of spurs in polymers .....	21
<i>Z.P. Zagorski</i>	
An overview of current developments in applied radiation chemistry of polymers .....	33
<i>O. Gueven</i>	
Radiation polymerization in solution .....	41
<i>J. M. Rosiak</i>	
Radiation-assisted compatibilization of polymers .....	61
<i>T. Czvikovszky</i>	
Nanopolymers and radiation .....	75
<i>M. Lavallo</i>	
Radiation curing of composites .....	79
<i>A.J. Berejka</i>	
Electron beam grafting of polymers .....	85
<i>A.J. Berejka</i>	
Degradation effects in polymers .....	91
<i>T. Czvikovszky</i>	
The use of electron beam for production of tough materials: The Italian experience .....	103
<i>M. Lavallo</i>	
Application of high power X ray generators for processing bulk materials .....	111
<i>M.R. Cleland</i>	
LIST OF PARTICIPANTS .....	123





## SUMMARY

### Introduction

The meeting on radiation effects on polymers was held at the Radiation Laboratory at the University of Notre Dame to review and discuss advances in the radiation processing of polymers. The trends in the basic research, R&D and industrial applications were reported.

The scope of more applied uses of irradiation involving polymers ranged from discussions of the curing of materials for dental applications, to the effects on polyolefins (the most broadly used class of polymers prevalent in industrial radiation processing) and to emerging interests in hydrogels, carbon fiber composites, heterogeneous mixtures based on material by-products (scrap plastic and wood fragments), grafted materials and materials for electronic uses. In addition, the emerging interests in the use of recently developed high power x ray systems for industrial use were presented.

### Basic insights

Presentations by D. Meisel, G. Hug and J. LaVerne, underscored the relationship between fundamental research in radiation mechanisms and the emerging uses in applied technology. . Investigations into the concerns over hydrogen gas evolution and other by-products involved in nuclear waste storage were found to shed light on mechanisms found in commercially viable uses of radiation processing.

Three insights emerged into basic mechanisms related to phenomena observed in the use of radiation chemistry in the processing of polymeric materials for commercial use:

- Charge transfer mechanisms,
- The transfer from the radiation induced charge within a particulate to its surface,
- The role of sulfur in reaction propagation to overcome oxygen inhibition.

The basic research into the mechanisms involved in the decomposition of nuclear waste brought focus onto events at the atomic level. For example, of concern in nuclear waste storage is the evolution of hydrogen gas from water surrounding stored radioactive material. Such hydrogen gas evolution is also a predominant by-product in the crosslinking of the most widely used polymer in radiation processing, polyethylene, albeit at significantly lower levels. Hydrogen abstraction from water and also the detachment of hydrogen from polyethylene in the carbon backbone of polyolefins may well proceed along similar charge transfer mechanisms. Z. Zagorski postulated that the crosslinking of a polyethylene involved both hydrogen abstraction, as is commonly stated, and also charge transfer along the polyethylene backbone leading to crosslinks, which in themselves may not always be simple carbon-to-carbon bonds between adjacent polymer chains, but also inter-chain crosslink segments involving a modest number of monomeric sequences.

In investigating the charge storage within an atom affected by radioactivity, J. LaVerne noted that the dimensions of the atom or atomic structure played a significant role in the ability of the stored charge to escape the surface and interact with adjacent layers of water. This mechanism may also be useful in understanding the application of radiation technology to nano-particulates. More modest irradiation exposures or doses may be needed in materials

fortified with treated nano-particulates on the supposition that excessive particulate size now merely retains or absorbs much of the radiation energy without permitting such from escaping to the particulate surface where it would be most efficacious.

In explaining the mechanism of ultra-violet light curing of materials for dental applications, G. Hug pointed out the role of sulfur bearing materials in extending the propagation step of free radical polymerizations such that oxygen would not interfere with the reaction. This observation is of major consequence in the low-energy uses of industrial radiation curing, such as used for the curing of inks and coatings, wherein a considerable economic burden is incurred in order to nearly eliminate oxygen in the atmosphere in which the curing takes.

### **Summary of advances in materials and process development**

An overview of the diverse developments in the application of radiation chemistry to emerging commercial applications was presented by O. Güven. The effectiveness of radiation degradation of polysaccharides to produce plant food that stimulates growth was detailed. The EB crosslinking of polytetrafluoroethylene (PTFE) at near its melt transition was shown to produce crosslink films with optical clarity, which may serve as the basis for fuel cell membranes or materials with exceptional irradiation resistance as needed in the space and nuclear power plant areas. Specialty grafted fabric was found to be odor absorbent. The surface modification of fine particle silicas with reactive monomers resulted in “nano-particulates” that not only enhance cured or crosslinked film properties, especially in terms of abrasion resistance, but also have minimal effect on the rheological properties of such materials prior to being incorporated into an EB crosslinked system.

By using ionizing radiation in dilute systems of polymeric materials commonly used in the electron beam (EB) manufacture of film forming hydrogels, J. Rosiak showed that these gels could be used as injectable materials into irritated joints. Micro-gel agglomerates were also shown to offer potential in other biomedical applications, including the selected delivery of bio-active materials or drugs to specific anatomical areas.

Heterogeneous composite materials made from waste or recycled components such as polyolefin polymers and wood fibers were shown to be made compatible by T. Czvikovszky through the use of small amounts of monomers that graft onto the two normally incompatible phases of said mixtures. These compositions demonstrated sufficient material properties to be used in the construction of truck and automotive components, such as door and side panels. To exploit the use of such recycled resources, process techniques in mixing and compounding had to be developed.

The effectiveness of using the thermal input for EB crosslinking of carbon-fiber composite matrix materials to reduce dose was shown by M. Lavalle. Proper combinations of monomer, sulfur and metals subjected to ionizing radiation were found to produce nano-particles that could be of use in electronic applications.

An up-date of the status of EB curing of carbon fiber composites was presented by A. Berejka. Developments proven successful for aerospace applications are now being seriously scrutinized for automotive use. The diversity of proven uses of radiation grafting for uses in batteries, porous film and non-woven filters, and release coated films and papers was also presented. Opportunities for use of grafting in biomedical applications, composites technology, and fuel cell membrane development were also discussed.

The emergence of high power x ray technology from high voltage, high current accelerators was described by M. Cleland. Such high power x-ray technology is of interest in the area of

food safety. This now commercially available technology can also be used for the crosslinking of thick cross-sectioned materials and composites.

G. Hug reported on the research concerning free-radical polymerization using thioethers in dental and other applications. A series of 1,3,5-trithiane derivatives, including  $\alpha$ - and  $\beta$ -isomers of the methyl and phenyl derivatives was investigated for use as co-initiators in benzophenone-induced photopolymerizations. The basic photochemistry was investigated using laser flash photolysis to measure triplet quenching rate constants and quantum yields for the formation of benzophenone ketyl radicals (and trithiane radicals). Photopolymerizations were then performed with benzophenone as the photosensitizer, trithianes as co-sensitizers, and multifunctional methacrylate monomers. The photopolymerization was monitored with differential scanning calorimetry. An attempt was made to correlate the quantitative aspects from the basic photochemical measurements on the benzophenone/trithiane systems and the results of the polymerizations with regard to the ease of polymerization using the various trithianes as co-initiators. Although the basic photochemical studies gave an indication of the formation rates and yields of co-initiator radicals, it turned out that the reactivity of the co-initiator radicals was adversely affected by the resonance stabilization of the phenyl compounds. In addition, the efficiency of the polymerization was also decreased by the formation of trithiane radicals in chain transfer processes. The  $\beta$ -isomer of the trimethyl substituted radical turned out to be the best co-initiator even though it did not produce the largest yield of radicals.

## Conclusions and recommendations

1. Trends in basic radiation chemistry concern research on:

- Interface reactions
- Single homogenous systems
- Complex systems (e.g. macromolecules)
- Spontaneously organized systems
- Model systems (pulse radiolysis)
- Nuclear waste management.

2. New trends in radiation chemistry of polymers

- Silicon-based chemistry
- Nano-particles
- Interfacial phenomena
- Targeted irradiation
- Controlled degradation
- Controlled crosslinking

3. Advances in radiation processing of polymers

- Health-care applications
  - Cell culturing
  - Improving biocompatibility
  - Drug delivery systems
  - Molecular imprinting
- Industrial applications
  - Composites
  - Polymeric alloys, blends
  - Specialty membranes
  - Radiation resistant materials (nuclear power, food packaging, medical applications)

- High-technology applications
  - High-temperature resistance
  - Nano-resolution lithography
  - Security related applications
- Environmental applications
  - Upgrading and modification of polysaccharides
  - Adsorbents for purification of water
- Agricultural applications
  - Plant-growth promoters
  - Environment-friendly fruit preservatives

# **BASICS OF RADIATION CHEMISTRY IN THE REAL WORLD: NANOPARTICLES IN AQUEOUS SUSPENSIONS**

D. MEISEL

Radiation Laboratory and Department of Chemistry & Biochemistry,  
University of Notre Dame, Notre Dame, Indiana, USA

**Abstract.** It hardly needs a reminder that the basic knowledge provided by the scientific enterprise underlies all technological applications. The body of information accumulated by the detailed fundamental studies of radiation chemistry is of no exception. It provides a solid foundation for many technologies already available on the market place. In the present report we describe our own experience in transferring fundamental studies to engineering issues in several technological applications. These issues are common to nuclear waste management, to the operation of nuclear utilities and to environmental remediation. In homogeneous solutions information obtained in the past on the rate of hydrogen generation in nuclear waste, temporarily stored in large tanks, can reasonably be predicted provided at least rudimentary information on the contents of the waste is known. Studies of the radiation chemistry of solutions commonly encountered in nuclear waste point to radicals of the NO<sub>x</sub> family as the major radicals of redox processes, in particular reactions that are important in degradation of organic complexants available in high-level waste. The interaction of these radical with organic molecules and the interaction of organic radicals with NO<sub>x</sub><sup>-</sup> ions are a major bottleneck in knowledge that hinders the development of predictive models that could describe the fate of organic molecules in these systems.

In this survey we focus on heterogeneous systems. We show that electrons produced by ionizing radiation that is deposited in silica nanoparticles can find its way into a surrounding aqueous phase from particles of at least up to 20 nm in diameter. This observation raises the question on the minimum size required to ensure trapping of the electrons in the solid particle. On the other hand, it also opens up opportunities to exploit charge carriers that are generated by the radiation in the solid to produce some useful chemistry at the interface between the two phases, for example, a solid oxide particle and an aqueous phase around it. This is quite relevant to a major topic of this meeting, the grafting of an organic polymer onto a solid matrix of an oxide. We then conclude that the effects of radiation at interfaces should be a focal point of research that will lead to technological development beyond the commonly evolving studies at a single phase systems. Beyond these specific examples from our own experiences, we demonstrate how basic knowledge developed by academic studies of the effects of radiation can lead to advancement of technologies far removed from the radiation sciences per se, from photography to catalysis.

## **Introduction**

A major thrust in the study of heterogeneous systems is to understand the chemical consequences of irradiating a multi-phase system [1]. Can the energy or charge carriers that are deposited in one phase be transferred across the interface to the other phase and what fraction remains arrested in each of the phases? Do the interface, its composition and the surface charge alter the outcome of the chemistry? In another direction ionizing radiation can be used as a synthetic tool to prepare particle suspensions. Many metallic particles and a few semiconductors as well, were prepared using this approach [2-6]. The advantage of using radiolytic approach over wet chemical methods is the ability to control the size and size distribution by controlling the dose-rate delivered to the precursors solution. A third direction focuses on mechanistic studies conducted on suspensions of nanoparticles. The suspensions allow time domain optical measurements, which are common in radiation research, and therefore are often utilized to study mechanisms of short-lived intermediates generated in the suspensions or during the process of growth. In this report we survey mostly recent observations from the first area of activity: transfer of energy or charge initially generated by ionizing radiation in one phase into the other.

Interfacial processes induced by ionizing radiation are of interest as a fundamental scientific question, as well as a technologically relevant concern. When high-energy particles

travel through a multiphase system, ionization and excitations occur at each of the phases. When the weight percentage of each phase is significant, these events occur in both phases and both phases. Often the consequences of the radiation in each of the phases is reasonably well understood but when the two phases coexist, in particular when the dimensions of one of the phases are small, interfacial charge or energy transfer can occur. The various possible pathways that the carriers can undergo are illustrated in Fig. 1. The electron or the hole can lose its excess energy and thermalize, it can localize in a trap state within the particle, and the two carriers can recombine. In parallel, the carriers may also cross into the other phase. This is the focus of the present discussion. The technologically relevant issue is the potential for radiolytic processes to occur preferentially in one of the phases. In the case of particles suspended in water, the potential for enhanced water radiolysis products, e.g. molecular hydrogen generation, is a very practical concern [7]. On the other hand, strategies to remedy contaminated soils may benefit from enhanced radiolytic yields in the aqueous phase of such heterogeneous systems [8]. Escape of charges from irradiated particles has important consequences for stored high-level-liquid waste, which invariably is heavily loaded with solid particles [7]. Various molecules adsorbed onto metal oxide particles or porous bulk materials have been shown to form radical anions, radical cations, or to decompose under the action of ionizing radiation due to charge migration to the interface [1]. As a result, possible applications of ionizing radiation to the degradation of adsorbed environmental pollutants are being explored [9, 10].

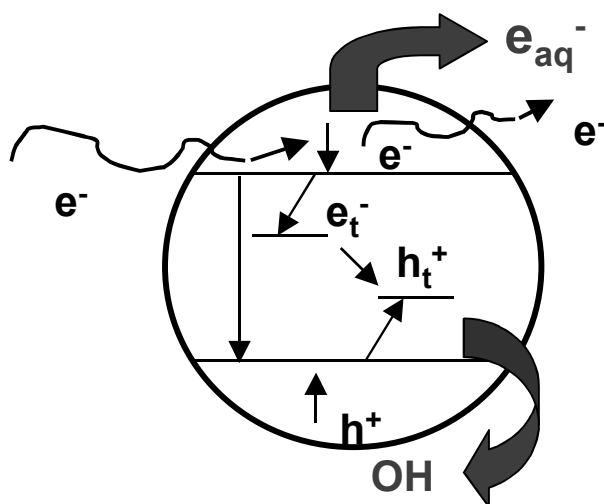

FIG. 1. Ionizing radiation in a nanoparticle in suspension. A high-energy particle ( $\approx MeV$ ) generates an electron-hole pair ( $\approx$  tens of  $eV$ ). Both carriers can thermalize, localize in traps, recombine, or cross the interface into the surrounding medium.

The role of metallic particles in catalytic conversion of all the reducing equivalents that are produced by radiolysis of water into molecular hydrogen has been demonstrated some time ago [11]. However, in these studies essentially no energy is deposited in the solid particles; rather the aqueous phase alone absorbed the energy. Radicals were generated in the water but their chemical fate was determined by the catalytic surface of the nanoparticles. In the present survey we focus on the inverse situation, the fate of electrons and holes generated in the solid.

Several groups studied the irradiation of wet oxide surfaces [12, 13]. In these studies only the a few monolayers in intimate contact with the solid were present. In several instances, as will be amplified in the following report, it was shown that yields of  $H_2$ , from

water layers on several oxides are very high [14, 15]. This high yield necessitates energy transfer from the solid material to the aqueous layers. The structure of the water at the first few adsorbed layers may significantly be different from bulk water and the behaviour of the few water layers under the field of radiation may then differ from that of bulk water. We, on the other hand, focus on radiolytic products from bulk water at the vicinity of suspended particles. By directly following the hydrated electrons we showed that their yield does not decrease upon addition of SiO<sub>2</sub> nanoparticles (7–22 nm in size) up to loading of 50% by weight [16]. On the other hand we found that holes remain trapped in the silica particle even at the smallest size available [17]. The observation that the production of OH radicals decreases upon loading the suspension with silica particles suggests that the trapped holes cannot oxidize water at the interface. However, the energy level at which they are trapped has not been determined. These observations are summarized in the following sections.

### **Energy deposition in particle suspensions**

As high-energy electrons pass through an aqueous colloidal suspension of particles, energy is lost via electronic interactions in both the liquid and solid phases in a ratio determined by their relative electron densities and concentration. Thus, as the percentage of solid material increases, so does the fraction of energy deposited in the solid phase. It is common to conduct radiolytic experiments at constant volume (to ensure constant geometry relative to the radiation source). Thus, the dose absorbed in the sample increases with the increase of total density of the sample. This is shown in Fig. 2 as the upper solid curve.

If the energy originally deposited in the particles remains in the solid, the total number of hydrated electrons observed in a given volume of sample must decrease upon increasing the weight % of the solid proportionately with the decrease in the volume fraction of water (lower solid curve in Fig. 2). If no electrons are transferred from the particles to the water, the concentration of e<sub>aq</sub> must decrease. The lower solid curve in Fig. 1 describes this expected decrease for SiO<sub>2</sub> in water suspensions. There is little doubt that when the particles are large enough this decrease will be followed because the electrons will either recombine or become trapped in the solid before reaching the interface. Nonetheless, when the particles are small, a fraction of the charge carriers may escape into the water.

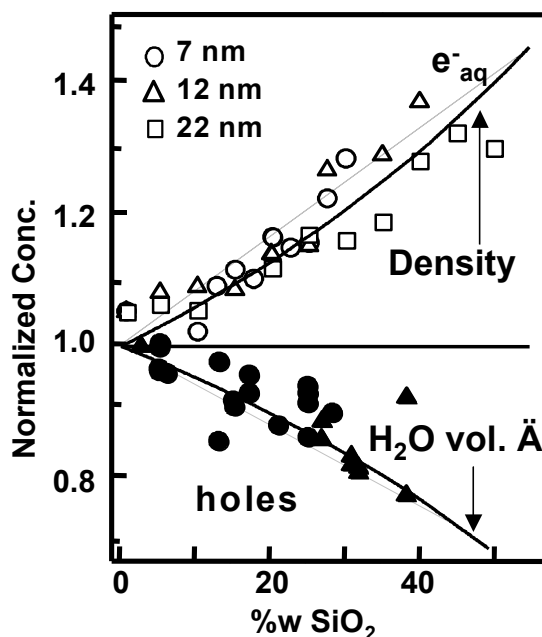

FIG. 2. Normalized concentrations of  $e_{aq}^-$  (upper half) and OH radicals (scavenged by SCN, lower half) vs. concentration of several size silica particles. The upper and lower solid curves are the increase in density and decrease of water volume with  $SiO_2$  loading, respectively.

## Experimental

Short-lived intermediates were determined using pulse-radiolysis of aqueous colloidal suspensions of silica or zirconia particles. The pulse radiolysis experiments were performed using 2-3 ns pulses of 8 MeV electrons from the Notre Dame linear electron accelerator. The doses used generated  $(1-10) \times 10^6$  M of solvated electrons. Spectrophotometric detection of the radicals was used in these experiments. Silica and zirconia, in addition to being a common material in many nuclear applications, are also transparent across the near UV-visible range allowing convenient detection of the radicals. No interference from trapped species in the particles could be observed in any of the suspensions. All experiments involving silica were performed in the basic pH range, where silica is negatively charged and thus the scavengers remain in the water phase, removed from the interface. Silica particles were DuPont Ludox products ranging in size from 7 to 22 nm in diameter. Zirconia suspensions were studied at pH 3-4 in the presence of high acetate concentrations to stabilize the suspensions. Whereas the particles at this pH are usually positively charged it is believed that ion pairing and specific surface adsorption at the high concentrations used modified significantly the surface.

## Escape of electrons into the aqueous phase

Attempts to determine the yield of charge carriers that escape from the particles to the water phase are scarce. The experimental data in Fig. 2 shows the concentration of hydrated electrons in silica suspensions as a function of the concentration of particles. These concentrations are normalized to the concentration of  $e_{aq}^-$  in neat water. They were measured as close as possible to the time of generation of the hydrated electrons following the electron pulse before significant recombination occurred. As can be seen in Fig. 2,  $e_{aq}^-$  concentration increases upon increasing the concentration of the particles. It is also clear that the size of the particles has little effect if any on the yield up to 22 nm particles. Taking the radius as the



average distance travelled by the escaping electron, one may compare it with results obtained from electron microscopy studies of metal oxide thin films [18, 19]. The most probable escape depth observed in these studies is ~25 nm.

The close similarity between the increase in the absorbed dose (upper curve in Fig. 2) and the concentration of hydrated electrons indicates the yield (expressed as the number of species generated per unit absorbed energy) of electrons in water remains unchanged even when 50% of the water has been replaced by silica. Clearly, electrons that are generated initially in the particles escape to the water. Furthermore, assuming that the initial yield of electron-hole pairs that are generated in silica is not very different from water, the majority of them escape. Indeed, even though the band gap in silica is ~9 eV, the lowest energy required for the generation of a separated electron-hole pair is ~20 eV [20]. Alig et al [21] suggested a correlation between the bandgap of the material,  $E_g$ , and the average energy required to produce an electron-hole pair,  $E_p$ :  $E_p \approx 2.73E_g + 0.5$ . This leads to  $E_p \approx 24$  eV for silica, and 14 eV for zirconia. Thus, the yield should increase in zirconia suspensions (expected  $G \approx 7$  electrons/100 eV).

Zirconia particles are difficult to maintain in transparent suspensions. Acetate stabilized (1.5 mole/mole  $ZrO_2$ ) 5-10 nm particles, up to 20% weight were used in these studies [22]. All experiments were conducted at pH 3.4 in solutions containing 2.76 M acetic acid. Under these conditions the majority of electrons are converted to hydrogen atoms. Electrophoresis of diluted suspensions shows that the surface charge of the particles is positive and the point-of-zero-charge was  $\approx 7$ . Methyl Viologen,  $MV^{2+}$ , was used to scavenge the reducing equivalents and all yields were compared to the same solutions containing no  $ZrO_2$ . At the  $MV^{2+}$  concentration used (10 mM) complete scavenging occurs to generate the reduced radical,  $MV^+$ . Figure 3 shows the concentration of  $MV^+$ , normalized to the yield in the absence of  $ZrO_2$ . The increase in  $MV^+$  concentration upon increasing  $ZrO_2$  loading far exceeds the absorbed dose and thus, the yield increases as well. At the highest  $ZrO_2$  concentration shown in Fig. 3 the yield increased by 50%, from 4.2 radicals/100 eV in the absence of the particles to 6.3 radicals/100 eV at 20% weight. Thus, one concludes that thermalization, recombination and trapping of charge carriers in the small  $ZrO_2$  particles are significantly less efficient than they are in water. It is possible that part of the increased yield results from conversion of holes to reducing radicals (e.g. from acetate). Another possibility is increased capture of electrons by surface adsorbed species as described below.

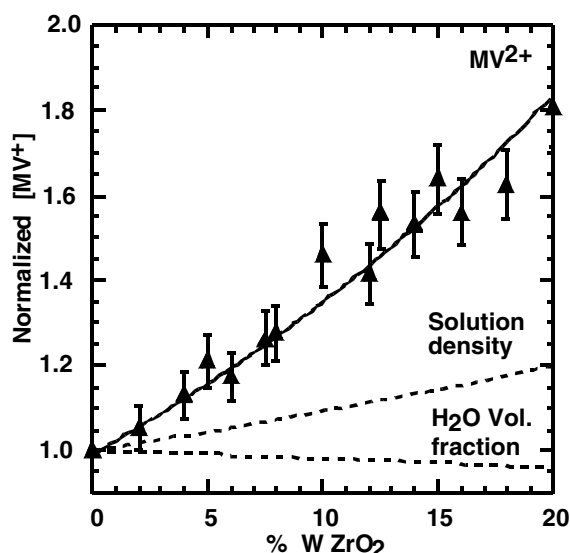

FIG. 3. Normalized concentration of  $MV^{+}$  as a function of % weight  $ZrO_2$ . Also shown are the increased dose absorbed by the sample (density) and the decrease in absorbed dose by the aqueous phase (volume fraction of  $H_2O$ ). The increase beyond the increase of the density indicates large increase in yield.

### Escape of holes into the aqueous phase

The mobility of hot holes in silica is much slower than that of electrons. Furthermore, many trapping sites for holes have been identified in silica. Thus, one may expect more efficient trapping of holes relative to electrons and consequently less escape into the aqueous phase. The yield of products from two OH scavengers,  $Fe(CN)_6^{4-}$  and  $SCN$ , was determined in silica containing suspensions. These negatively charged scavengers are expected to reside exclusively in the aqueous phase. The result from suspensions of particle of 7 and 12 nm in diameter are shown in Fig. 2 (lower half of the figure). Upon increasing the loading the relative yield of OH radicals decreases. These results seem to follow the solid lower curve in Fig. 2, which describes the fraction of energy absorbed by the aqueous phase. Thus, the only observed OH radical products seem to be those that were generated from radiolysis of the aqueous phase and no holes cross the interface even from the smallest particles available. On the other hand, an increase in the yield of oxidation equivalents in the water upon loading the suspensions with  $ZrO_2$  particles was observed [22].

### Interfacial capture of carriers

It is of interest to test the effect of the interface on the yields of charge carriers. At least two parameters of the interface can be externally modified the surface potential and the chemical identity of species at the interface. If these parameters can modify the yield, then the yields may be controlled externally. These possibilities were studied in silica suspensions [23]. To change the surface potential of the silica particles  $Mg^{2+}$  ions were added to the suspensions. The yields of  $e_{aq}$  were measured with and without these ions with essentially the same results. One concludes that a significant reduction in the negative charge density at the surface has little effect on the yield of  $e_{aq}$ .

Similar experiments to those described in Fig. 2 for the yields of hydrated electrons from silica suspensions were repeated with  $MV^{2+}$  added. All of the  $MV^{2+}$  acceptors were adsorbed on the silica particles at the conditions of these experiments as was evident from the reduction of the rate of  $e_{aq}^-$  reaction with  $MV^{2+}$ . Furthermore, from the ionic strength dependence of the rate constant for this reaction, it was shown that the hydrated electrons react against a negative potential (rather than positive if  $MV^{2+}$  has been free in solution). Hydrated electrons that originate from direct ionization of water in the same suspensions were scavenged by  $NO_3^-$  ions in the bulk of the aqueous phase. The yield of electrons captured by  $MV^{2+}$  was found to track the fraction of dose absorbed by the silica particles. Since this is also the contribution of silica to the total generation of solvated electrons, one concludes that the acceptors at the surface can capture all the electrons that cross the interface. Yet, recent results indicate that the presence of acceptors at the interface affects competing processes within the particle, such as recombination, trapping, and escape [25]. These results illustrate the difficulties of determining the yields of charge carriers when the energy levels of the solid are within the gap allowed by water (e.g. Fig. 3). Once scavengers are required in order to measure the yield of charge carriers the effect of the scavenger needs to be examined.

### **Radiolysis as a synthetic tool**

Numerous reports describe the use of radiolysis in the synthesis of metallic nanoparticles and a few extend this approach to the synthesis of semiconductor particles. Henglein and coworkers [25, 26] and Belloni and coworkers [5, 27, 28] describe the radiolytic reduction of many metal ions either single metal or in combination of a variety of metals to generate metallic or bimetallic mixtures as well as core-shell structures. To obtain metallic particles from their parent ions one only needs to ensure reductive conditions during the irradiation. The oxidizing equivalents, OH radicals, can conveniently be converted to reducing radicals by the addition of organic scavengers (e.g. alcohols, formate ions) that will produce reducing radicals. The radiolytic approach may offer some advantages because of the fine control over the rate of generation of the growing species afforded by the control over the dose rate delivered to the sample. Furthermore, the mechanism of nucleation and growth can be delineated [5, 28] and properties, such as absorption spectra or redox potentials, of the growing clusters can be determined [29, 30]. By judicious selection of the parent metal ion or complex narrow size distribution of the particles at predetermined sizes can be achieved [3]. To generate core-shell structures one would rely on the large difference in redox potentials between the reduction of the parent ion to a single atom and its reduction to the bulk metal. The presence of core seed particles of the first metal will then serve as the seeds for the shell metal. Using this strategy only few new seeds are generated and most of the reduction occurs on top of the existing seeds. When the same metal (but a different parent complex so the redox potential allows only reduction at the surface of “seeds”) is deposited on existing seeds the synthesis leads merely to increase in the particle sizes. However, because the rate of growth is inversely proportional to the square of the size, whereas the rate of reduction is directly proportional to the size, the net rate of size increase is inversely proportional to the size. This results in narrowing of the size distribution as the particles grow. The smaller particles grow faster than the larger ones.

To initiate radiolytic growth of semiconductors one component of the material, e.g.  $Ag^+$  or  $Cd^{2+}$  is added to the solution. An organic precursor that contains the counter ion,  $RX$ , where  $X^-$  is a halide or chalcogenide, is also added. The reaction of  $RX$  with  $e_{aq}^-$  releases the

counter ion, X and the growth of the nanoparticles can be followed [31, 32]. The main reason to use radiolytic techniques to initiate the production of the particles is to study the mechanism of their growth and the properties of the various intermediates. Using this approach the absorption spectrum of the single molecule (e.g. AgX, CdS) could be measured and the equilibrium constant between the molecule and its component ions can be determined. As might be expected, these studies reveal that the single molecule dissociates into its component ions to a much larger extent than the bulk material.

## Conclusions

This report summarizes the effects of ionizing radiation on nanoparticles suspensions in aqueous media. Radiolytic methodologies to synthesize nanoparticles of metals and semiconductors in suspension were developed and radiolytic techniques to outline mechanisms of a large number of processes at the surface of the particles have been reported. However, the focus of the present report is on radiolytic yields and on interfacial exchange of charge carriers between the solid particle and the aqueous phase. It is clear that the interface does not offer a barrier to exchange of carriers. On the contrary, the presence of the solid phase often enhances products from the fragmentation of water molecules. Clearly, the production of radicals at the interface may be utilized to a variety of processes such as polymerization at the surface or grafting onto the solid. Furthermore, the interfacial crossover processes have practical technological applications where ionizing radiation and radioactivity are present. Absorption of radiation by the surfaces of pipelines in nuclear reactors can contribute to radiolytic water dissociation and thus to the generation oxidizing intermediates, hydroxyl radicals or hydrogen peroxide. These are the major source of corrosion processes in the cooling system lines reactors. Similarly, nuclear materials stored as powders in sealed cylinders can accumulate water from humid environments. The irradiated water then can generate high quantities of gases not merely from direct irradiation of the water but from the radiation energy absorbed by the solid material. Nuclear waste stored in tanks as heterogeneous suspensions waiting permanent disposition can lead to water products, including flammable gas mixtures, from absorption of dose in both phases. On the other hand, the deep penetration of ionizing radiation together with the exchange of carriers among the phases might be utilized to increase the efficiency environmental clean-up processes.

## REFERENCES

- [1] THOMAS, J. K., 'Physical Aspects of Photochemistry and Radiation-Chemistry of Molecules Adsorbed on SiO<sub>2</sub>, Gamma-Al<sub>2</sub>O<sub>3</sub>, Zeolites, and Clays', *Chem. Rev.* **1993**, 93, 301–320.
- [2] HENGLEIN, A., MEISEL, D., 'Radiolytic control of the size of colloidal gold nanoparticles', *Langmuir* **1998**, 14, 7392–7396.
- [3] HENGLEIN, A., 'Nanoclusters of Semiconductors and Metals. Colloidal Nanoparticles of Semiconductors and Metals. Electronic structure and Processes', *Ber. Bunsenges. Phys. Chem.* **1997**, 101, 1562–1572.
- [4] KHATOORI, J., MOSTAFAVI, M., RIDARD, J., AMBLARD, J., BELLONI, J., 'Kinetics of Cluster Growth by Aggregation', *Z. Phys. D* **1995**, 34, 47–56.
- [5] GACHARD, E., REMITA, H., KHATOORI, J., KEITA, B., NADJO, L., BELLONI, J., 'Radiation-Induced and Chemical Formation of Gold Clusters', *New J. Chem.* **1998**, 22, 1257–1265.

- [6] a) HAYES, D., MICIC, O. I., NENADOVIC, M. T., SWAYAMBUNATHAN, V., MEISEL, D., 'Radiolytic production and properties of ultrasmall CdS particles', *J. Phys. Chem.* **1989**, *93*, 4603–4608.
- b) HAYES, D., SCHMIDT, K. H., MEISEL, D., 'Growth mechanisms of silver halide clusters from the molecule to the colloidal particle', *J. Phys. Chem.* **1989**, *93*, 6100–6109.
- c) SWAYAMBUNATHAN, V., HAYES, D., SCHMIDT, K. H., LIAO, Y. X., MEISEL, D., 'Thiol Surface complexation on growing CdS Clusters', *J. Am. Chem. Soc.* **1990**, *112*, 3831–3837.
- [7] ORLANDO, T., MEISEL, D., 'Radiation-Induced Processes in Aqueous Suspensions of Nanoparticles and Nanoscale Water Films: Relevance to H<sub>2</sub> Production in Mixed Waste and Spent Nuclear Fuel', In 'Nuclear Site Remediation', ELLER, G., HEINEMAN, W. R. (eds), *ACS Symposium Series*, **2001**, *778*, 284–296.
- [8] ZACHEIS, G. A., GRAY, K. A., KAMAT, P. V., 'Radiation-Induced Catalysis on Oxide Surfaces: Degradation of Hexachlorobenzene on  $\gamma$ -Irradiated Alumina Nanoparticles', *J. Phys. Chem. B* **1999**, *103*, 2142–2150.
- [9] LAWLER, A., 'Researchers Vie for Role in Nuclear-Waste Cleanup', *Science* **1997**, *275*, 1730.
- [10] STAFFORD, U., GRAY, K. A., KAMAT, P. V., 'Radiolytic and TiO<sub>2</sub>-Assisted Photocatalytic Degradation of 4-Chlorophenol. A Comparative Study', *J. Phys. Chem.* **1994**, *98*, 6343–6351.
- [11] HENGLEIN, A., LILIE, J., 'Storage of Electrons in Aqueous Solution: The Rates of Chemical Charging and Discharging of the Colloidal Ag Microelectrode', *J. Am. Chem. Soc.* **1981**, *103*, 1059–1066.
- [12] ZHANG, G., MAO, Y., THOMAS, J. K., 'Surface Chemistry Induced by High Energy Radiation in Silica of Small Particle Structures', *J. Phys. Chem. B* **1997**, *101*, 7100–7013.
- [13] SHKROB, I. A., TADJIKOV, B. M., CHEMERISOV, S. D., TRIFUNAC, A. D., 'Electron Trapping and H Atoms in Oxide Glasses', *J. Chem. Phys. B* **1999**, *111*, 5124–5140.
- [14] LaVERNE, J. A., TANDON, L., 'H<sub>2</sub> Production in the Radiolysis of Water on CeO<sub>2</sub> and ZrO<sub>2</sub>', *J. Phys. Chem. B* **2001**, *106*, 9316–9322.
- [15] PETRIK, N. G., ALEXANDROV, A. B., VALL, A. I., 'Interfacial Energy Transfer During Gamma Radiolysis of Water on the Surface of ZrO<sub>2</sub> and Some Other Oxides', *J. Phys. Chem. B* **2001**, *105*, 5935–5944.
- [16] SCHATZ, T., COOK, A. R., MEISEL, D., 'Charge Carrier Transfer Across the Silica Nanoparticle / Water Interface', *J. Phys. Chem.* **1998**, *102*, 7225–7230.
- [17] DIMITRIJEVIC, N. M., HENGLEIN, A., MEISEL, D., 'Charge Separation Across the Silica Nanoparticle/Water Interface,' *J. Phys. Chem. B*, **1999**, *103*, 7073–7076.
- [18] SEILER, H., 'Secondary Electron Emission in the Scanning Electron Microscope', *J. Appl. Phys.* **1983**, *54*, R1–R18.
- [19] KANAYA, K., ONO, S., ISHIGAKI, F., 'Secondary Electron Emission from Insulators', *J. Phys. D: Appl. Phys.* **1978**, *11*, 2425–2437.

- [20] PETR, I., 'Production of Electron-Hole Pairs in SiO<sub>2</sub> Films.', *J. Radioanal. Nucl. Chem., Letters* **1985**, *95*, 195–200.
- [21] ALIG, R. C., BLOOM, S., STRUCK, C. W., 'Scattering by Ionization and Phonon Emission in Semiconductors', *Phys. Rev. B* **1980**, *22*, 5565–5582.
- [22] TREGUER, M., D. MEISEL, *To be published*.
- [23] SCHATZ, T., COOK, A., MEISEL, D., 'Capture of Charge Carriers at the Silica Nanoparticle — Water Interface', *J. Phys. Chem. B* **1999**, *103*, 10209–10213.
- [24] MILOSAVLJEVIC, B. H., MEISEL, D., *To be published*.
- [25] HENGLEIN, A., 'Electronics of Colloidal Nanometer Particles', *Ber. Bunsenges. Phys. Chem.* **1995**, *99*, 903–913.
- [26] HENGLEIN, A., 'Mechanism of Reactions on Colloidal Microelectrodes and Size Quantization Effects', *Top. Curr. Chem.* **1988**, *143*, 113–180.
- [27] MARIGNIER, J. L., BELLONI, J., DELCOURT, M. O., CHEVALIER, J. P., 'Microaggregates of Non-Noble Metals and Bimetallic Alloys Prepared By Radiation-Induced Reduction', *Nature* **1985**, *317*, 344–345.
- [28] KHATOURI, J., RIDARD, J., MOSTAFAVI, M., AMBLARD, J., BELLONI, J., 'Kinetics of Cluster Aggregation in Competition with a Chemical Growth Reaction', *Z. Phys. D* **1995**, *34*, 57–64.
- [29] HENGLEIN, A., 'Remarks on the Electrochemical Potential of Small Silver Clusters in Aqueous Solution', *Ber. Bunsenges. Phys. Chem.* **1990**, *94*, 600–603.
- [30] MOSTAFAVI, M., MARIGNIER, J. L., AMBLARD, J., BELLONI, J., 'Size-Dependent Thermodynamic Properties of Silver Aggregates. Simulation of the Photographic Development Process', *Z. Phys. D* **1989**, *12*, 31–35.
- [31] SCHMIDT, K. H., PATEL, R., MEISEL, D., 'Growth of Silver Halides from the Molecule to the Crystal. A Pulse Radiolysis Study', *J. Am. Chem. Soc.* **1988**, *110*, 4882–4884
- [32] HAYES, D., MICIC, O. I., NENADOVIC, M. T., SWAYAMBUNATHAN, V., MEISEL, D., 'Radiolytic Production and Properties of Ultrasmall CdS Particles', *J. Phys. Chem.* **1989**, *93*, 4603–4608

# HYDROGEN GENERATION IN TRANSURANIC WASTE STORAGE CONTAINERS

J. LA VERNE

Radiation Laboratory, University of Notre Dame,  
Notre Dame, Indiana, USA

**Abstract.** The long term storage of nuclear waste materials has been a major technological and political concern that has affected the advance of nuclear power production. Stored materials will undergo self-radiolysis for many years and the integrity of the materials, the storage containers, and most importantly the storage site must be maintained. Many radiation chemistry studies can be directly applied to the storage of waste materials containing polymers, especially high-level waste consisting of gamma and beta emitters. These studies can be used to predict the production of various hazardous gases. However, the radiation chemistry of polymers induced by the alpha particles of transuranic waste is poorly understood. Many polymers have never been examined for their susceptibility to decomposition by alpha particles and reliable models for extrapolation from other types of radiations do not exist. In addition, nuclear waste materials are commonly a mixture of different types of compounds and even different phases. Energy transfer between phases and interfacial chemistry will affect the rate and type of products formed in these systems. The resolution of some of the basic radiation chemistry concerns would greatly enhance public confidence in the management of nuclear waste materials.

The management of nuclear waste materials created in defense and power generation endeavours presents major technological and scientific challenges. There are approximately 155,000 cubic meters of stored transuranic waste in the US inventory, contained in about  $\frac{3}{4}$  million 55 gallon drums [1]. Transuranic waste consists of low levels of actinides and may be combined with other mixed low-level radioactive materials. The waste may include residuals from processing, construction equipment and simple trash. Self-radiolysis of these materials is constantly changing its composition causing problems for shipping and storage. Eventually, the transuranic waste in the US is destined for the Waste Isolation Pilot Plant in New Mexico. However, considerable effort is still required to characterize each waste container and prepare it for final disposal. A substantial amount of fundamental science must be accumulated for the safe and efficient cleanup of these materials.

The most common problem encountered in the self-radiolysis of waste materials is the generation of gaseous  $H_2$  and/or  $O_2$ . Sources of these gases include water, polymers, and other organic materials. High pressures of gaseous products may lead to explosion or flammability concerns. Many radiation chemistry studies can be directly applied to the storage of waste materials containing polymers, especially high-level waste consisting of  $\gamma$ -ray and  $\beta$ -particle emitters [2]. These results can be used to predict the production of various hazardous gases from relatively simple polymeric mixtures. However, the radiation chemistry of polymers induced by the  $\alpha$ -particles of transuranic waste is poorly understood. Many polymers have never been examined for their susceptibility to decomposition by  $\alpha$ -particles and reliable models for extrapolation from other types of radiation do not exist.

In addition to emitting various types of radiation, nuclear waste materials are commonly mixtures of different compounds and even different phases. Energy transfer between phases and interfacial chemistry will affect the yields and types of products formed in these systems. Interfacial effects in radiation chemistry have long been observed, but the detailed mechanisms involved are not understood [3-5]. Recent studies of water adsorbed on ceramic oxides clearly show that energy can migrate from the solid oxide phase to the water phase and lead to excess production of  $H_2$  [6, 7]. This process complicates dosimetry because energy

deposition that was previously thought to be lost to the oxide can induce a radiolytic effect at the surface. The radiation chemistry at interfaces is clearly dependent on several parameters of the oxide, such as the type and size. Predictive models for estimating the energy available for radiation chemistry have not been developed and considerable more experimental and theoretical work in this area is necessary.

### **Interfacial effects in transuranic waste**

The production of H<sub>2</sub> in the radiolysis of water has been extensively re-examined in recent years [8]. Previous studies had assumed that the main mechanism for H<sub>2</sub> production was due to radical reactions of the hydrated electron and H atoms. Selected scavenger studies have shown that the precursor to the hydrated electron is also the precursor to H<sub>2</sub>. The majority of H<sub>2</sub> production in the track of heavy ions is due to dissociative combination reactions between the precursor to the hydrated electron and the molecular water cation. Dissociative electron attachment reactions may also play some role in  $\gamma$ -ray and fast electron radiolysis. The radiation chemical yield, G-value, of H<sub>2</sub> is 0.45 molecule/100 eV at about 1 microsecond in the radiolysis of water with  $\gamma$ -rays. This value may be different in the radiolysis of adsorbed water because of its dissociation at the surface, steric effects, or transport of energy through the interface.

One to three water layers can be adsorbed on oxide particles such as CeO<sub>2</sub> and ZrO<sub>2</sub> by placing them in humid atmospheres. The number of water layers is nearly invariant up to about 85% relative humidity [7]. At higher relative humidity, the number of water layers increases significantly due to the filling of mesopores. The  $\gamma$ -radiolysis of water adsorbed on nanometer sized particles leads to the direct energy deposition in both phases. The relative distribution of this energy is determined by the electron density of each material. Normally, one would consider the energy deposited in the oxide to be “wasted”, that is, not available for radiation chemistry in the water phase.

Figure 1 shows the yield of H<sub>2</sub> in the radiolysis of CeO<sub>2</sub> and ZrO<sub>2</sub> particles as a function of the number of water layers on the particle surface. The G-value was determined relative to the energy initially deposited in the water layer alone. A yield significantly different than 0.45 molecule/100 eV indicates an additional contribution to the radiolysis of adsorbed water. It can be seen in Fig. 1 that the H<sub>2</sub> yield increases with decreasing number of water layers. The radiolysis of ZrO<sub>2</sub> with a monolayer of water has an apparent yield of H<sub>2</sub> that is more than two orders of magnitude greater than expected for the radiolysis of bulk water. In fact, a G-value greater than 100 molecules/100 eV implies less than 1 eV/molecule of H<sub>2</sub>. No covalent bonds exist at this level in water, so energy must be migrating to the water layer from the bulk oxide. This migration of energy is due to electrons, excitons, or other transients produced by the deposition of energy in the solid oxide and it makes radiation yields in mixed phase systems difficult to predict.



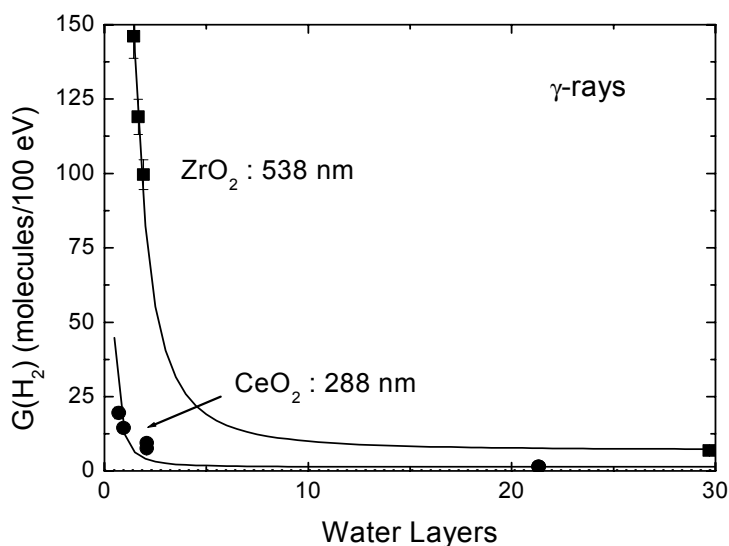

FIG. 1. Yield of H<sub>2</sub> as a function of the number of water layers adsorbed on CeO<sub>2</sub> and ZrO<sub>2</sub>. Yield is determined with respect to the energy deposited directly into the water [7]

The transport of energy through interfaces is not well understood, but the main carriers are thought to be electrons and excitons. Particle size clearly makes a difference since electrons and excitons produced in a particle have a finite diffusion length [6, 9, 10]. More studies are required to determine the different types of transient species in various oxides, their transport to the surface, and the mechanism for making H<sub>2</sub>. Interfacial effects can obviously lead to the production of more H<sub>2</sub> from the radiolysis of water associated with waste materials than anticipated from bulk studies on homogeneous systems. The production of H<sub>2</sub> and O<sub>2</sub> may lead to explosive or flammability concerns in certain situations. It is unknown if similar energy migration occurs in polymers, that is, if energy deposited in the bulk polymer can induce radiation chemistry in another compound on its surface.

The results of Fig. 1 are for  $\gamma$ -radiolysis. It can be seen that there is more H<sub>2</sub> production with ZrO<sub>2</sub> than with CeO<sub>2</sub>. Excitons are thought to be the precursors for this excess H<sub>2</sub> production with ZrO<sub>2</sub> [6]. The transport of energy through interfaces is also observed for 5 MeV helium ion radiolysis suggesting similar interfacial effects will be found in transuranic waste materials [7]. However, the yields of H<sub>2</sub> from water adsorbed on both CeO<sub>2</sub> and ZrO<sub>2</sub> are similar. The high LET appears to quench the precursor for the excess H<sub>2</sub> yield from water adsorbed on ZrO<sub>2</sub>. One difficult aspect in the characterization of transuranic waste is that surrogates must often be used for radiation chemistry studies. The preliminary results suggest that both CeO<sub>2</sub> and ZrO<sub>2</sub> are suitable surrogates for the  $\alpha$ -particle radiolysis of transuranic materials.

The migration of energy between phases will also have an effect in the radiolysis of mixed polymeric systems not associated with transuranic waste. For instance, the radiolysis of polymers attached to silica particles or the radiolysis of rubber in steel belted tires will probably be affected by energy deposited in the non-organic phase. Energy migration to the polymeric phase may lead to the need for lower overall doses than initially anticipated for a

desired result. There is no method for predicting the energy available in a particular system and further fundamental research on heterogeneous systems is required.

### **Polymer radiolysis in transuranic waste**

Gas formation is the main process of concern in the radiolysis of polymers in association with transuranic waste materials. Most simple organic polymers are expected to produce H<sub>2</sub> and methane to a smaller extent. Carbon dioxide and carbon monoxide can also be produced in selected polymeric materials containing oxygen [2]. H<sub>2</sub> is almost always the main gaseous product in simple organic polymers, but its yield is strongly dependent on the type of polymer. For instance, the G-value for H<sub>2</sub> is 3.3 molecules/100 eV for polyethylene and 0.033 molecule/100 eV for polystyrene [11]. This large variation in H<sub>2</sub> yield on polymer type makes it difficult to predict the production of H<sub>2</sub> for mixtures or for polymers not yet examined. Model systems based on good fundamental studies must be developed to predict radiolytic yields of H<sub>2</sub> in polymers.

Highly penetrating radiation, such as  $\gamma$ -rays or fast electrons, deposits energy throughout the solid target material. Gas production occurs within the solid phase and must diffuse to the surface to be observed. The apparent yield of H<sub>2</sub> can depend on the radiolysis procedure or the particle size if some of the gas remains in the solid. Experiments have shown that the apparent yield of H<sub>2</sub> can vary by a factor of 3 in the radiolysis of polyethylene spheres of 7 to 2100 cm<sup>2</sup>/g (about 9 to 0.03 mm) [12]. The effects of gas trapping and diffusion are not understood in the context of waste storage. Extremely high dose rates in the processing of certain materials may lead to bubble formation, which could alter product quality.

The yield of H<sub>2</sub> in the radiolysis of polymers with  $\gamma$ -rays is well known for several types of polymers [2]. However, transuranic waste materials are  $\alpha$ -particle emitters. The radiation chemistry induced by  $\alpha$ -particles can be very different than that due to  $\gamma$ -rays because of the difference in energy deposition density [13]. The high linear energy transfer (LET, equal to the stopping power) of heavy particles leads to an increase in second order reactions, which may change the yields of some products.

Figure 2 shows the results for the production of H<sub>2</sub> as a function of track average LET for polyethylene, PE, polypropylene, PP, poly (methyl methacrylate), PMMA, and polystyrene, PS [11]. The particles are completely stopped in these experiments because of their very short range so the yields with heavy ions represent an average over the entire track.

The H<sub>2</sub> yield from polystyrene irradiated with  $\gamma$ -rays is two orders of magnitude less than that in polyethylene. The H<sub>2</sub> yields increase with increasing LET for all the polymers shown in Fig. 2, but the increase is not linear. There is a considerably greater increase for polystyrene than polyethylene. A 5 MeV helium ion,  $\alpha$ -particle, gives a G-value for H<sub>2</sub> of 4.6 molecules/100 eV from polyethylene and 0.15 molecule/100 eV from polystyrene [11]. The large increase in H<sub>2</sub> yield for polystyrene suggests that this material is not as radiation inert as typically thought. The use of yields determined with  $\gamma$ -rays for heavy ion radiolysis would clearly underestimate the production of H<sub>2</sub> in transuranic waste materials. More experiments coupled with sophisticated models are required to predict H<sub>2</sub> yields in other unexamined polymers and in complex mixtures.

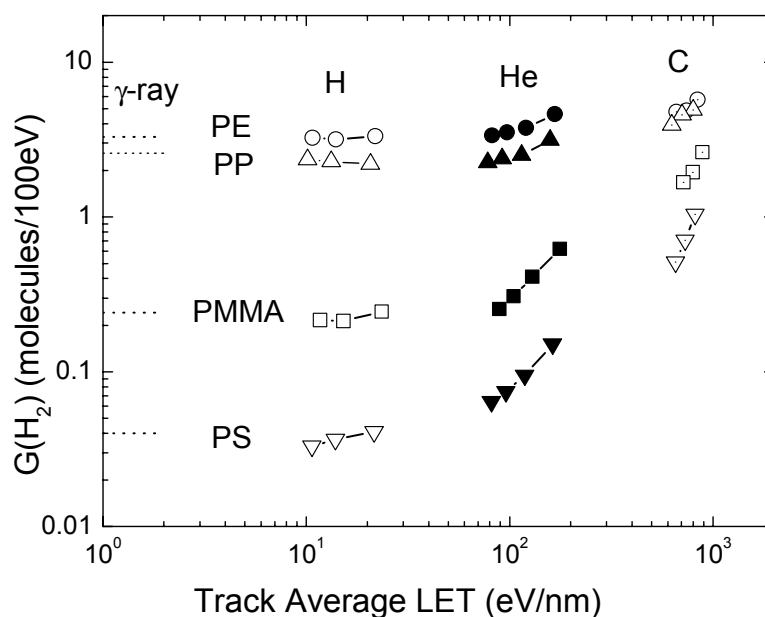

FIG. 2. Yield of  $H_2$  as a function of track average LET for polyethylene, PE, polypropylene, PP, poly(methyl methacrylate), PMMA, and polystyrene, PS, irradiated with  $\gamma$ rays, protons, helium ions and carbon ions [11]

### Specific recommendations for further fundamental studies

The preceding discussion elucidated a few of the problems associated with polymer radiolysis in association with transuranic waste materials. The actual systems are very complicated and involve mixtures of materials and different phases. Considerable time and effort must be committed to fundamental research on solving these problems of major concern to society. A few of the many unresolved radiation chemistry issues involved in the management of transuranic waste materials are:

- the buildup of gaseous products such as  $H_2$ ,  $CH_4$ ,  $O_2$ ,  $CO$ , and  $CO_2$  may lead to overpressurization of sealed containers used in shipping or in enclosed environments;
- concurrent production of  $H_2$  and  $O_2$  may lead to explosion or flammability hazards;
- self-induced polymer degradation due to chain scission and cross-linking may lead to loss of structural integrity;
- radiolytic decomposition is known to vary with the type of radiation and the use of  $\gamma$ -ray data to predict  $\alpha$ -particle radiolysis is often erroneous, which makes estimations of polymer degradation in mixed waste difficult;
- accurate redistribution of energy deposition in heterogeneous mixtures is virtually impossible to obtain because of energy transfer between phases;
- radiation induced catalytic effects due to heterogeneous interfaces are expected, but unexplored.
- radiolysis of associated materials such as salts from processing can contribute to gas production and may also alter normal chemical reactions associated with polymer degradation;
- eventual corrosion of containers due to products of radiolysis can be expected for many systems, for example Cl from PVC, but the mechanisms are not well understood;

- the exact mechanism for the production of H<sub>2</sub> in polymers is not known and may involve contributions by excited states, electrons, and holes, making it difficult to predict yields for materials not specifically examined.

## REFERENCES

- [1] NATIONAL RESEARCH COUNCIL, Research Opportunities for Managing the Department of Energy's Transuranic and Mixed Waste, the National Academies Press, Washington, D. C. 2002.
- [2] TABATA, Y., ITO, Y., TAGAWA, S. (eds), CRC Handbook of Radiation Chemistry, CRC Press, Boca Raton, 1991.
- [3] CAFFREY, J. M. JR., ALLEN, A. O., J. Phys. Chem. **1958**, 62, 33.
- [4] RABE, J. G., RABE, B., ALLEN, A. O., J. Phys. Chem. **1966**, 70, 1098.
- [5] SAGERT, N. H., DYNE, P. J., Can. J. Chem. **1967**, 45, 615.
- [6] PETRIK, N. G., ALEXANDROV, A. B., VALL, A. I., J. Phys. Chem. B, **2001**, 105, 5935.
- [7] LaVERNE, J. A., TANDON, L., J. Phys. Chem. B **2002**, 106, 380.
- [8] LaVERNE, J. A., PIMBLOTT, S. M., J. Phys. Chem. A **2000**, 104, 9820.
- [9] ZHANG, G., MAO, Y., THOMAS, J. K., J. Phys. Chem. **1997**, 101, 7100.
- [10] LaVERNE, J. A., TONNIES, S. E., J. Phys. Chem. B **2003**, 107, 7277.
- [11] CHANG, Z., LaVERNE, J. A., J. Phys. Chem. B **2000**, 104, 10557.
- [12] CHANG, Z., LaVERNE, J. A., J. Phys. Chem. B **1999**, 103, 8267.
- [13] MOZUMDER, A., Fundamentals of Radiation Chemistry, Academic Press, New York, 1999.

# RADIATION CHEMISTRY OF SPURS IN POLYMERS

Z.P. ZAGORSKI

Department of Radiation Chemistry and Technology,  
Institute of Nuclear Chemistry and Technology,  
Warsaw, Poland

**Abstract** The aim of the present work is the extension of the concept of spurs to the field of radiation chemistry of polymers. The idea proved to be very helpful in radiation chemistry of water and aqueous solutions. Basic radiation physics shows that single- and multi-ionization spurs are inherent in deposition of energy in any medium. Although the participation of multi-ionization spurs in low LET (linear energy transfer) radiations, like gamma and electron beam used in radiation processing and pulse radiolysis is low (ca 20% of total energy deposited), their effects are important and very different from single ionization spurs reactions. Present paper summarizes earlier experience of the Author but supplies new data concentrating on yields of hydrogen and radiation induced crosslinking of polyethylene and elastomers.

## Introduction

Present paper summarizes conference presentations of the Author in 2002-2003 [1-4] (published as summaries) and papers relevant to the present topic, published in the recent 5 years and the unpublished work, giving new generalizations and outlook for further research. It incorporates polymer aspects of the IAEA CRC devoted to dosimetry, in which the Author was participating, as well as of three projects financially supported by the Polish Committee for Science. The last one, still running is headed by the Author. The paper involves also collaboration with three polymer Institutes, two belonging to Technical Universities, one to the industrial institute of rubber industry. The latter is not able to have radiation chemistry equipment and know how, and *vice versa*, our nuclear institute cannot be in possession of modern equipment and know how of a laboratory involved in basic research and development in the field of polymers.

Present paper involves also two oral presentations at the IAEA Consultants Meeting (CT) on "Advances in Radiation Processing of Polymers", 13-17 September 2003, Radiation Laboratory, University of Notre Dame, Notre Dame, Indiana, USA (no abstracts or summaries published)

## Spurs — basic phenomenon in radiation chemistry

The role of spurs was dominating the field of radiation chemistry of water and aqueous solutions at the beginning of that branch of chemistry. The concept of spurs was born more than half of a century ago and developed here, in the Radiation Laboratory, University of Notre Dame, In., USA where the present meeting takes place (c.f. [5]). The basic experimental observation was the independent formation of so called molecular products of water radiolysis, i.e. hydrogen and hydrogen peroxide and very reactive radical products like OH and H (hydrated electron was not discovered at that time yet). Differences of reactivity of both groups of products were so substantial, that the radical products were destroying molecular products, if there were no other reactants in the irradiated solution. That is the case in pure reactor water in which radiolysis into oxygen and hydrogen is negligible.

Origin of different nature of both kinds of primary products of radiolysis was found in different size of spurs, as the centers of radiation induced chemical reactions were called. The

site of the formation of molecular products of water radiolysis was identified as the final location of degradation of energy of ionizing particles which had so low range that deposited energy very close one to another. That assumption was supported by the observation of radiation yields obtained with more dense ionizing radiations, like protons and alpha rays. Yields were easily correlated with LET (linear energy transfer) value of the applied radiation - higher LET value caused relative higher yield of hydrogen and hydrogen peroxide. At the same time the observation was made, that the radiation of lowest LET value available, i.e. gamma radiation emitted by cobalt 60 always, and independently from the dose, was producing  $H_2$  and  $H_2O_2$  with constant yields of  $G_{H_2} = 0.45$  and  $G_{H_2O_2} = 0.8$  resp. per 100 eV of absorbed energy.

Meanwhile it became clear, that spurs in any medium are segregated into single and multi-ionization spurs, located at high distances one from another. The starting quanta of gamma radiation, (e.g. 1.17 and 1.33 MeV in the case of  $^{60}Co$ ) or fast electrons (e.g. of up to 10 MeV in the case of linear electron accelerator) are interacting stepwise with irradiated medium, producing cascades of secondary electrons and quanta. The latter are ionizing again and so on in single ionizations, far away one from another. The range of 10 MeV electron beam in water, or in similar, low Z medium like C, H, O, N polymer, is ca 40 mm, what means, that assuming 10 eV per ionization, in the average the distance of ... molecules of water, or  $-CH_2-$  units is covered. However, terminal generations of electrons have a low energy, and therefore a short distance to travel, what results in several ionizations, close one to another. The situation was first described graphically by Arnim Henglein [6]. A slightly modified diagram (Fig.1) from his book shows this effect, leading to the formation of multi-ionization spur. It can supply up to 500 eV energy in a volume of the order of  $1000 \text{ \AA}^3$  cubic nanometers. Multi-ionization spurs are not concentrated at the end of the range of electron beam, but are distributed randomly in the whole energy deposition zone used for radiation processing with the scanned beam [7]. It is caused by statistically occurring short tracks, at any distance from the face of irradiated object. Therefore they do not resemble the Bragg curve, which describes the deposition of energy by heavy ionizing particles.

It is clear that even radiations of lowest LET value, most penetrating, must deposit concentrations of energy in narrow zones on the molecular level. From experiments on aqueous solutions and later on solids, one can assume, that ca 80% of energy is deposited in single ionizations. That proportion turns into increase of participation of multi-ionization spurs with the increase of the LET value of the applied radiation. Effects of proton beam of comparatively low energy of 10 MeV are already easy to recognize.

One should realize, that single events like those shown on Figure 1 are simplifications, showing one series of events only. Each event runs slightly different, but it contributes to the average. Thus the large number of events gives the precise value of yields. It resembles the radioactive decay: one cannot guess which of the particular nuclei will decay, but a comparatively large sample of radioactive isotope shows a precise and well defined half lifetime of activity. Here, in the radiation chemistry, we cannot predict the fate of a chosen single 10 MeV electron entering the sample, how the cascade will be branched, what will be the partition into single and multi-ionization spurs. But the beam of already billions of electrons of average energy of 10 MeV, scanned over the conveyor („broad beam geometry") shows well defined and reproducible depth dose curve and the curve of charge distribution [7].

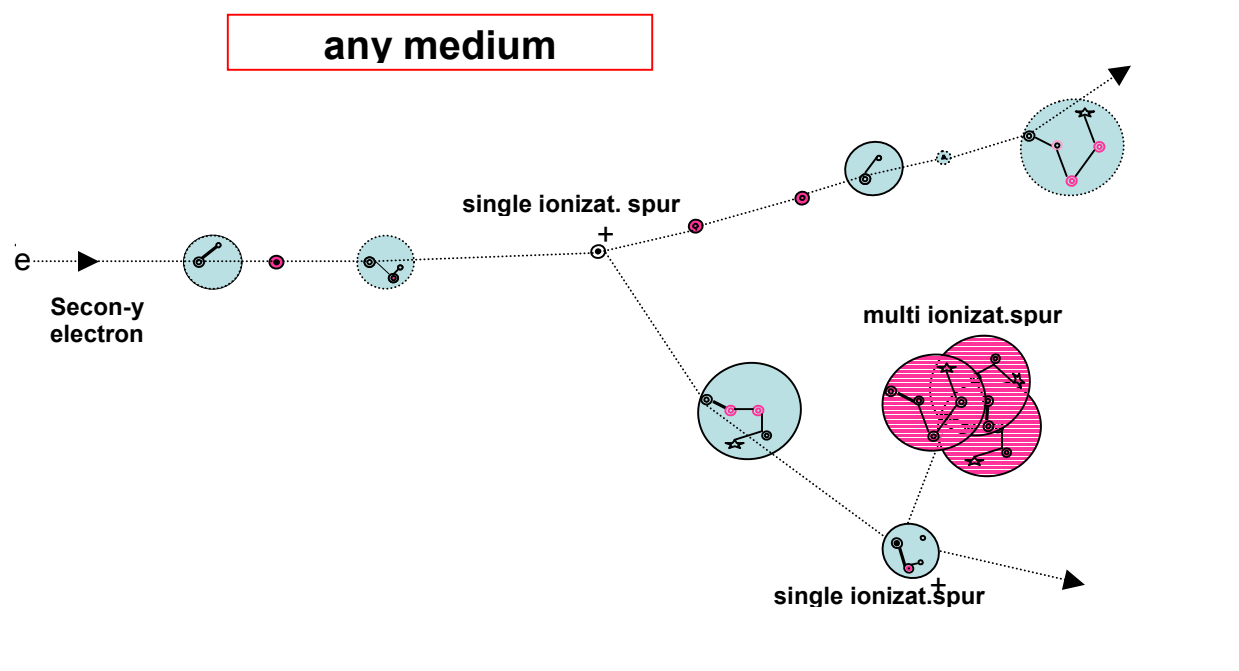

Fig. 1. Origin of multi-ionization spurs: electrons of last generation deposit the energy in a small region (ca 20% of total absorbed energy of low LET radiation).

### Experimental approach to spurs recognition in nonaqueous media

The first phase of the fundamental development of spurs concept was closed, when the radiation chemistry of water and aqueous solutions has reached the possibility to predict the result of irradiation of aqueous solution containing a defined solute. In computer assisted calculations of competing reactions, basic radiation yields of radical and molecular products of water radiolysis are entered, and results of application of defined dose are obtained. Absolute rate constants of reactions of thousands of solutes with water derived radicals are available, but even when some are not determined yet, computer programs can help in making approximate fittings. Even earlier experimental methods were known to arrange simple competitions helping to calculate the unknown rate constant. Radiolytic products of water can be considered as reagents towards added solute, because in the case of diluted solutions radiation interacts practically with water only, not with the solute.

Water soluble polymers behave like other solutes, i.e. radiation interacts with water principally and products of radiolysis react with the polymer. If the polymer is composed from different meres, what is the case with biopolymers, different segments of the polymer can have different rate constants of reaction with water derived radicals, c.f. the case of gelatin zols and gels [8]. The radiation chemistry of polymers dissolved in water is the chemistry of reactions with OH, H,  $e_{aq}^-$ ,  $H_2O_2$  and not, sensu stricto, of the polymer itself. Experiment shows clearly, that the radiation chemistry of the same polymer, but in the dry or almost dry state is completely different from radiation chemistry of its aqueous solution. Spurs are formed in the dry polymer and not in water.

Already in the beginnings of radiation chemistry, the experiments on irradiation of nonaqueous systems did not yield as a clear picture concerning spurs as the situation in water. For instance, in hydrocarbons there were no simple analogues of molecular hydrogen and hydrogen peroxide in water. All sizes of spurs were producing the same final products and

there were no means to distinguish their origin. Therefore the basic experimental approach — product analysis was not very conclusive.

The question arises, how to distinguish experimentally the radiation yields of chemical products of single- and multi-ionization spurs. One has to realize, that practically in all irradiated systems, two different sets of chemistry develop — one from products of single ionization spurs, the second from multi-ionization spurs. The mistake of many researchers consists in treating all effects as originating in the same processes. Situation is complicated, because in many systems products of both paths are identical and to distinguishing them seems hopeless. The simplest situation is in water and aqueous solutions, because products of both types of spurs are very different. Products of single-ionization spurs are reactive free radicals, whereas those from multi-ionization spurs are lazy reacting hydrogen peroxide and molecular hydrogen.

The next example of comparatively simplicity, this time nonaqueous, is the crystalline alanine. There are several products of irradiation of that solid crystalline amino acid. In this state it occurs as zwitterion; as NMR shows, i.e. the amine group is protonated  $-N^+H_3$ . Single ionization spurs, of a low energy, cause deamination which leads to detachment of ammonia and formation of a free radical. Pulse radiolysis of single crystals of L-alanine shows, that the alanine derived radical  $CH_3-C^{\bullet}H-CO_2^-$ , which shows the spectrum with maximum at 348 nm [9], stabilizes during 5 milliseconds [10]. It is usually observed not spectroscopically but by the EPR method [11]; it shows extreme stability, being applied as reference dosimeter.

Single ionization spurs deliver energy sufficient for detachment of ammonia only. However, multi-ionization spurs of much higher energy concentrated in the molecule of alanine are able to detach  $CO_2$  in the reaction of decarboxylation. Irradiation of solid alanine in closed cell, dissolution it in water to release products and gas chromatographic determination of carbon dioxide we have found the radiation yield of 0.95 [12], similar to molecular products in water radiolysis. In contrary to comparative monoenergetics of single ionization spurs, the multi-ionization spurs have broader energetic spectrum, which can reach even 500 eV. Therefore multi-ionization spurs in alanine can contribute to the production of ammonia also, but that effect is not important. Important is the radiolytic production of  $CO_2$  specific to multi-ionization spurs.

What effects of spurs can be expected in irradiated polymers? First of all, physics of formation of single- and multi-ionization spurs and specifically the partition of energy roughly into 80% of first and 20% of latter, has to be preserved as long as only light elements are involved. That practically refers involves all polymers which contain C, H, O, F, N, S, Cl. Significantly different primary response can occur with polymers containing bromine and iodine. With low LET values radiations, mainly gammas from cobalt 60 and electron beams of 0.3–13 MeV energy, basic responses should be similar.

Let us discuss the role of multi-ionization spurs in polymers. It is expected to contribute to 20% of total energy deposited only, but its responsible for specific products, as we have seen on the example of water and alanine. Figure 2 shows the effect of multi-ionization spurs on hydrocarbon chain. Deposition of energy in amounts exceeding the energy deposited in single ionization spurs, causes the scission of the chain. As there is no upper limit of energy of multi-ionization spurs (it can reach 500 eV) the destruction of the chain around the scission can go deeper and result in formation of debris of the polymer. These debris on the Figure are consistent with low molecular weight compounds found by many authors (some results collected in [13]) by analysis of gaseous products of radiolysis of CH polymers.



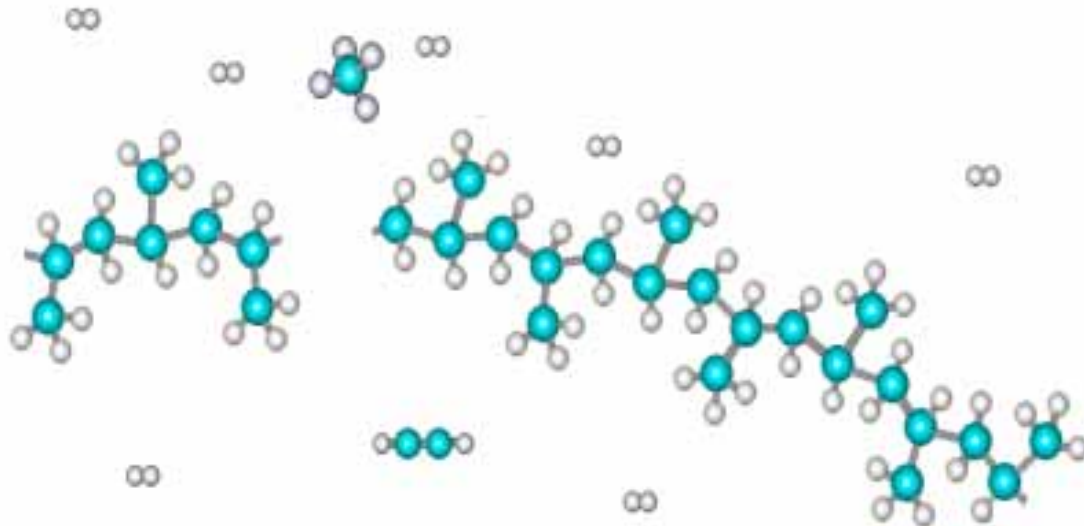
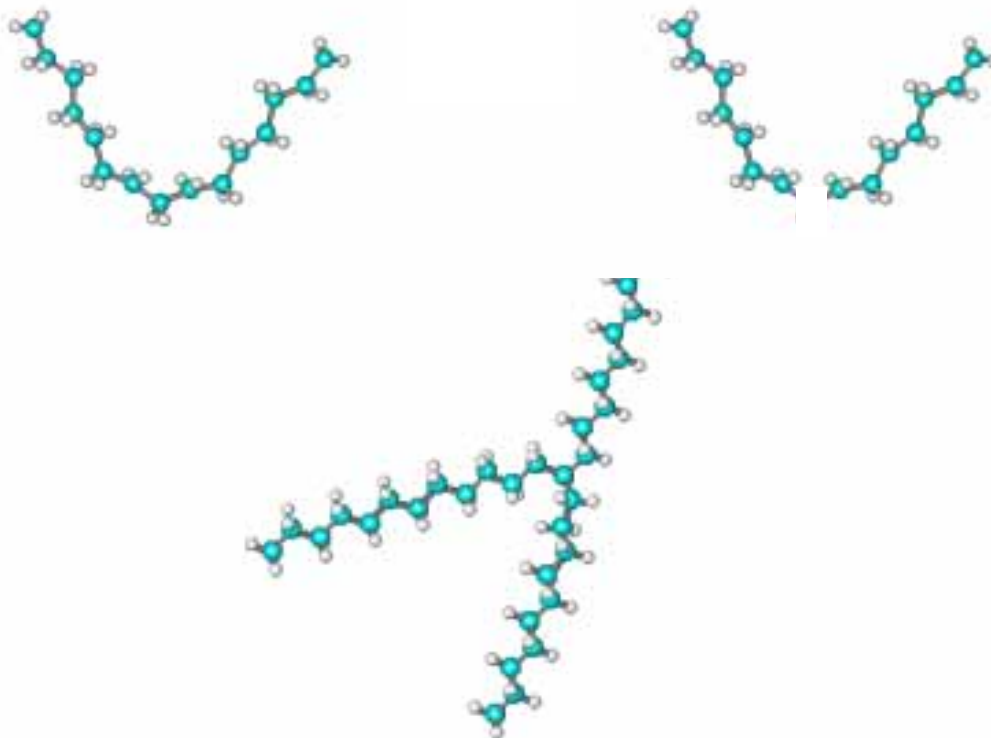

*Fig. 2. Multi-ionization spur in C,H polymers: chain scission, and if spur energy > 100 eV, also debris present, e.g. acetylene, methane and increased yield of hydrogen.*

It is astonishing to realize, that these authors did not make a conclusion, that low molecular weight products can form only as the result of dramatic disruption of the chain. Subtle changes caused by single ionization spurs are not able to produce these compounds (see *infra*).

Low molecular products of multi-ionization spurs could be considered as indicators of the radiation yield of multi-ionization spurs, as these products cannot be formed by single-ionization spurs. However, they are only a part of large spurs products, which include cleaved chains. The difficulty with multi-ionization spurs is, that they are of very different size, connected with their long spectrum of deposited energy of 30-500 eV. Very different kinds and amounts of small debris reported in the literature are caused by that variety of energies.

Low molecular weight products of multi-ionization spurs in polymers do not play an important role in general results of radiolysis. On the contrary, the active free radical terminals of broken chain are very important, if they are formed in polymers able to crosslink, i.e. which are on the list formulated already 50 years ago [14]. In the most popular crosslinking polymer, i.e. polyethylene, the free radical end attacks the closest place of the neighboring, intact chain (Fig.3). That is the origin of Y-type crosslinks, called in polymer chemistry also trifunctional. They are responsible for partial reduction of radiation initiated degradation of polymers. In the case non-crosslinking polymers, as in the case polypropylene shown in Fig. 2, this crosslinking reaction is not possible, multi-ionization spurs are the main source of degradation of polymer [15]. Therefore the yield of degradation in not crosslinkable polymers, like polypropylene could be considered as the measure of the radiation yield of multi-ionization spurs. That possibility has not been exploited experimentally yet.



---

*Fig. 3. Reactive end of interrupted polyethylene chain (from multi-ionization spur) reacts with another chain in the neighbourhood, forming Y-type crosslink.*

The single ionization spurs give rise to different chemistry in irradiated polymers. Multi-ionization spurs occur in an accidental place in the monomer and cause destruction which does not travel. The crosslinks formed by reactive terminals are also fixed by accidental sites of terminals neighboring energetically favorable place in another chain. Single ionization spurs occur also at accidental places of the chain, but consist of positive hole, which is able to travel along the chain to a energetically favorable place, e.g. closely situated group of another chain, or molecule of an additive with aromatic ring. The last possibility is very important, because it changes the energetically disturbance into heat without chemical reaction. Such energy transfer explains the rather strange fact, that low concentration of a molecule representing an energy sink, not taking part in the primary absorption of energy, nevertheless lowers the radiation yields of radiolysis. Figure 4 shows the formation of a crosslink between two macromolecules of polyethylene. Crosslinking of polyethylene is only a fragment of large field of radiation processing of polymers, but not the only one [16].

Our research on spurs has been extended to elastomers, more interesting because of complexity of the formula, but at the same time giving more opportunities of research, due to the lack of crystalline phase and resulting transparency. As the object of investigation, the hydrogenated acryl-butadiene rubber (HNBR) has been chosen, showing excellent results of radiation induced crosslinking [17, 18].

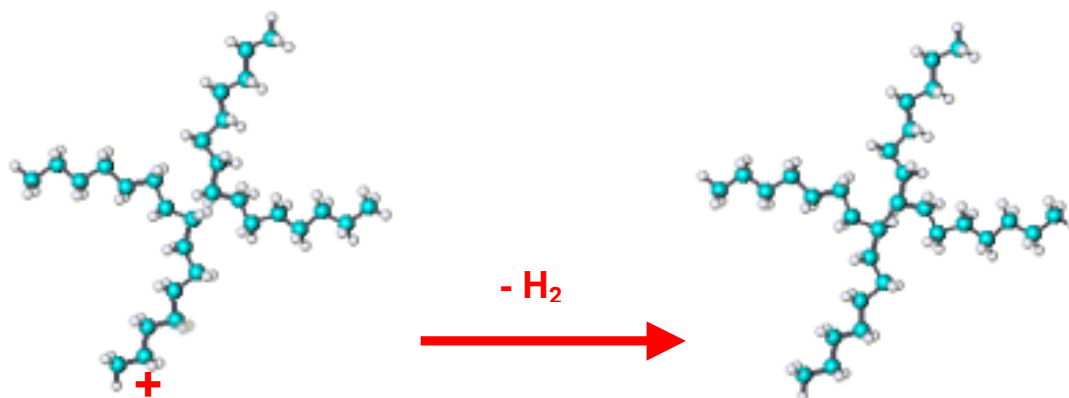

Fig 4. X-type crosslinking of polyethylene from a single ionization spur.

### Radiation yield of hydrogen in irradiated polymers

More than a half of a century ago polymers entered application in nuclear reactors technology as isolation of electric cables. Whereas rubber behaved well, at least up to a certain absorbed dose, there were objections to apply cables with polyethylene isolation. Fire and possible explosion of hydrogen, originating in the polyethylene isolation was considered a danger. The reason was, that the content of hydrogen in polyethylene ( $\text{CH}_3\text{--}[\text{--CH}_2\text{--}]_n\text{--CH}_3$ ) was not very much lower than in the basic hydrocarbon fuel for internal combustion engines ( $\text{CH}_3\text{--}[\text{--CH}_2\text{--}]_m\text{--CH}_3$ ) where  $n \gg m$ . No chemical chain reaction was developed and the moderate formation of hydrogen was connected with crosslinking of polyethylene, radiation induced. Improved properties of polyethylene, unexpected at that time, opened new branch of radiation chemistry - radiation processing.

Although the radiation yield of hydrogen from irradiated polymers became no concern from the point of view of safety, it remained the object of interest from the point of view of mechanisms of radiation induced chemical reactions. In analogy to water radiolysis, the yield of hydrogen became of interest if radiations of higher LET values were used for irradiation of polymers [19]. These are proton beams and alpha radiation, which can suggest different yields of hydrogen, and they really do.

As the formation of hydrogen is connected not only with crosslinking, but with other radiation induced reactions as well, parallel determination of it, along with other measurements on irradiated polymers was necessary also in our research. A system has been developed, of irradiation integrated with determination of hydrogen, covering several orders of magnitudes of doses. For this purpose the linear electron accelerator LAE 13/9 has been adapted. Investigated polymer is placed in a 3 ml ampoule closed with rubber septum, used for medical preparations, e.g. antibiotics lyophilized in the manufacturing process. Vials with material to be irradiated are irradiated by narrow beam of electrons. Only the lower part of the vial, containing the polymer is irradiated and the strayed, weak radiation does not influence the rubber septa, what has been proved by irradiation of material which did not contain hydrogen. The vials are positioned in the electron beam with help of laser beam. In some experiments irradiations of vials with investigated polymers were made with scanned beam of

electrons and samples placed horizontally on the conveyor, under the electron window. In that case the top of the vial with the septa was contained in a thick "hat" made of lead. Again, no traces of hydrogen has been found in irradiated vials, empty, or containing glass powder. All modes of irradiation were controlled with different dosimetric systems. All irradiations were made by split dose technique to avoid warming by more than 30 K jump of temperature and resulting additional thermal effects.

Immediately after irradiation and cooling to the temperature in air conditioned gas chromatograph room, the gas phase of the vial, above the polymer was sampled with the precision Hamilton syringes of 10, 25 or 500  $\mu\text{L}$  volume and transferred to the gas chromatograph. Measurements were made on gas chromatograph Shimadzu-14B connected to the PC computer by analogue-digital interface ADAM. The software CHROMNEW and CHROMAP was provided by the Department of Radiation Chemistry and Technology. The 1 m long column was packed with molecular sieves 5A, the detector was TCD Shimadzu. The carrier gas was argon (99.99%), flowing at 10 ml/min, temperature of column was 70<sup>0</sup>C and of the detector 100<sup>0</sup>C. The system was calibrated before each series of experiments.

Results were presented on diagrams as amount of hydrogen at normal conditions vs the absorbed dose. Radiation yields were calculated. Figure 5 shows the result for polyethylene, low in additives, for low and high range of doses. The production is linear in both ranges. Figure 6 shows production of hydrogen in the same coordinates from irradiated hydrogenated nitrile-butadiene rubber, chosen as more complicated elastomer. This time one can see the difference in the hydrogen production at low doses, it is diminished, due to the use of supplied energy for changes of non-rubber compounds present in the material. It resembles the shape of crosslinking diagrams, which also show the crosslinking phenomena, due to the presence of additives (Fig.7).

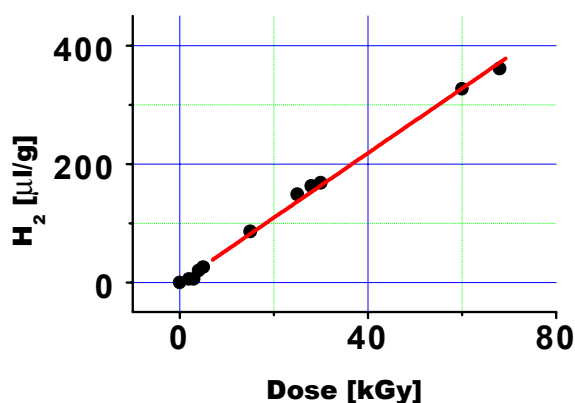

Fig. 5. Hydrogen production from irradiated polyethylene of low additives content.

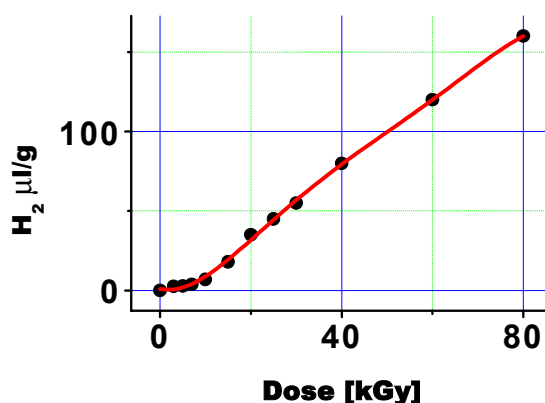

Fig. 6. Hydrogen production from irradiated hydrogenated nitrile-butadiene rubber (HNBR) with additives: The low doses curve shows „incubation” zone of hydrogen production caused by the reacti of primary radiolysis products with additives.

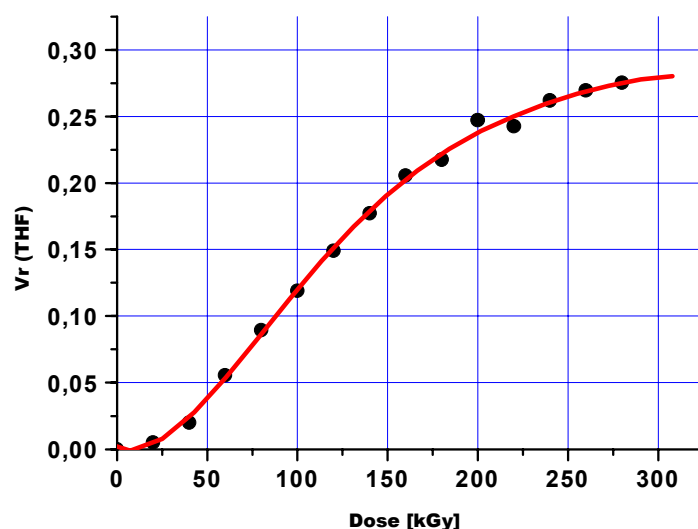

Fig. 7. Crosslinking of the HNBR elastomer with additives.

The diminished yield of hydrogen production gives rise to conclusions on the yield of multi-ionization spurs in that polymer. The radiation yield of hydrogen in the starting zone of doses is five times lower than at larger dose. Evidently, that diminished yield is due to the sole source of hydrogen, from multi-ionization spurs. These are formed at random parts of the macromolecule and there is no chance to hit the additive compound, present in low concentration. Single ionization spurs are hitting the molecule also at random places, but are able to move to the additive, where they are neutralized without hydrogen production, e.g. by dissipation of energy on aromatic groups.

## Conclusions

The rather non-conventional approach to radiation chemistry of polymers leads to conclusions which indicate that the role of multi-ionization spurs in radiation chemistry of polymers cannot be neglected. In spite of low participation of these spurs in radiolysis of low Z materials (ca 20% of total deposited energy), these spurs can explain formation of two basic, different types of crosslinks. Formation of low molecular weight products of radiolysis is also explained, as well as other phenomena. Application of spurs philosophy to polymers is also advantageous in explanation of energy transfer from single ionization spurs and lack of transfer from multi-ionization spurs.

There is no need to look into the spur chemistry in aqueous solutions of polymers, because spurs are formed in water as the main constituent, and radiation induced reactions are those of water derived products, attacking the polymer. In solid polymers however, the primary reactions are those from spurs in polymers proper. Majority of papers do not deal with spurs, but analyzing the published data, one can distinguish the role of multi-ionization spurs. They are responsible for chain scissions in non-crosslinking polymers. In crosslinking polymers, mainly in polyethylene and many elastomers, some scissions are forming crosslinks of the Y type, thus diminishing the degradation of the polymer.

Different paths of chemical changes from both types of spurs can express the hope that new effects will be found, connected with the identification of multi-ionization spurs, as the interpretation of hydrogen yield in irradiated HNBR at starting doses shows. More running

investigations, EPR and spectrophotometric measurements, also time resolved are promising in that respect. Especially the latter are easy to perform, because elastomers, including HNBR, are transparent, are transparent, due to the lack of crystalline moieties.

Part of this research is supported by the Polish State Committee for Science, Project No. 7T08E 016 21.

## REFERENCES

- [1] BIK, J., GLUSZEWSKI, W., RZYMSKI, M., ZAGÓRSKI, Z.P., 'EB radiation crosslinking of elastomers', 10th 'Tihany' Symposium on radiation chemistry, Sopron Aug.31–Sept.5, 2002, Abstract P-54.
- [2] DZIEWINSKI, J., ZAGÓRSKI, Z.P., 'Radiation chemistry of polymeric components of radioactive waste', 5th International Symposium on Ionizing Radiation and Polymers, Sainte-Adèle (Québec) Canada, Sept. 21–26, 2002. Abstract P-161, 183.
- [3] ZAGÓRSKI, Z.P., DZIEWINSKI, J., CONCA, J., 'Radiolytic effects of plutonium', International Conference Plutonium Futures — the Science, Albuquerque, New Mexico, 6–10 July 2003, AIP Conference Proceedings, New York, Vol.673, 336–338.
- [4] ZAGÓRSKI, Z.P., 'EB — crosslinking of elastomers, how does it compare with radiation crosslinking of other polymers', International Meeting on Radiation Processing Chicago 2003, Sept. 7–12, Book of Abstracts.
- [5] SAMUEL, A.H., MAGEE, J.L., 'Theory of radiation chemistry, II. Track effects in radiolysis of water', *J.Chem.Phys.* **21** (1953) 1080.
- [6] HENGLEIN, A., „Einführung in die Strahlenchemie, Verlag Chemie, Weinheim (1969) 400 pp, p.63.
- [7] ZAGÓRSKI, Z.P. 'Dependence of depth-dose curves on the energy spectrum of 5 to 13 MeV electron beams', *Radiat.Phys.Chem* **22** (1983) 409–418.
- [8] ZAGÓRSKI, Z.P. 'Aqueous gelatine gels as the medium of pulse radiolysis', *Radiat.Phys.Chem.* **34** (1989) 839–847.
- [9] ZAGÓRSKI, Z.P., RAFALSKI, A., 'A thin alanine-polyethylene film dosimetry system with diffuse reflection spectrophotometric evaluation' *J.Radioanal.Nucl.Chem., Articles*, **196** (1995) 97–105.
- [10] ZAGÓRSKI, Z.P., SEHESTED, K., 'Transients and stable radical from the deamination of  $\alpha$ -alanine', *J.Radioanalyt.Nucl.Chem.* **232** (1998) 139–141.
- [11] PRZYBYTNIAK, G.K., ZAGÓRSKI Z.P., 'Orientation of crystals in alanine dosimeter assessed by DRS, as seen in EPR spectra evaluation', *J.Radioanal.Nucl.Chem., Letters* **212** (1996) 373–382.
- [12] ZAGÓRSKI, Z.P., 'Solid state radiation chemistry - features important in basic research and applications', *Radiat.Phys.Chem.* **56** (1999) 559–565.
- [13] MILINCHUK, V.K., TUPIKOV, V.I. (Eds), *Organic Radiation Chemistry Handbook*, Wiley, New York (1989) 385 pp.
- [14] LAWTON, E.J., BUCHE, A.M., BALWIT J.S., "Irradiation of polymers by high energy electrons", *Nature* **172** (1953) 76–77.
- [15] ZAGÓRSKI, Z.P. 'Modification, degradation and stabilization of polymers in view of the classification of radiation spurs' *Radiat.Phys.Chem.* **63** (2002) 9–19.

- [16] ZAGÓRSKI, Z.P., GLUSZEWSKI W., RZYMSKI, W.M., „Modification of polymers by radiation” (Pol) in *Advances in the Processing of Polymeric Materials* (J.Koszkul, ed.), Czestochowa Technical University 2002, 307-314.
- [17] BIK, J., SMEJDA, A., WOLSKA, B., RZYMSKI, W.M., GLUSZEWSKI W., ZAGÓRSKI\*, Z.P., ‘Radiation crosslinking of hydrogenated butadiene acrylo-nitrile rubber’ (Pol) in *Advances in the Processing of Polymeric Materials* (J.Koszkul, ed.), Czestochowa Technical University 2002, 298–306.
- [18] BIK, J., GLUSZEWSKI W., RZYMSKI, W.M., ZAGÓRSKI\*, Z.P., „EB radiation crosslinking of elastomers”, *Radiat.Phys.Chem.* **67** (2003) 421–423.
- [19] CHANG, Z., LA VERNE J.A., „Hydrogen production in  $\gamma$ -ray and helium ion radiolysis of polyethylene, polypropylene, poly(methyl-methacrylate) and polystyrene” *J. Polym.Sci. A* **38** (2000) 1656–1661.





# AN OVERVIEW OF CURRENT DEVELOPMENTS IN APPLIED RADIATION CHEMISTRY OF POLYMERS

O. GUEVEN

Department of Chemistry, Hacettepe University,  
Ankara, Turkey

**Abstract.** A review of recent developments in the use of ionizing radiation in the modification, upgrading and changing the properties of polymers has been made by considering recently implemented applications and results of research and development efforts. Specific examples and cases were collected under the titles of crosslinking, curing, grafting and degradation of polymers. Significant developments reaching the industrial application stage have been noted in the gradient crosslinking of ultra high molecular weight polyethylene in the molten state for total joint arthroplasty. High temperature irradiation of polymers such as polycarbonate and polysulfone, which are radiation degrading types, has lead to improved surface hardening and resistance to wear.

A review of recent developments in the use of ionizing radiation in the modification, upgrading and changing the properties of polymers has been made by considering recently implemented applications and results of research and development efforts. Specific examples and cases were collected under the titles of crosslinking, curing, grafting and degradation of polymers. Significant developments reaching the industrial application stage have been noted in the gradient crosslinking of ultra high molecular weight polyethylene in the molten state for total joint arthroplasty. High temperature irradiation of polymers such as polycarbonate and polysulfone, which are radiation degrading types, has lead to improved surface hardening and resistance to wear.

## Introduction

Irradiation of polymers and plastics with high energy radiation (gamma rays, X rays, electron beams, ion beams) leads to the formation of very reactive intermediates in the forms of excited states, ions and free radicals. These intermediates are almost instantaneously used up in several reaction pathways which result in the arrangement or formation of new bonds structures. The ultimate effects of these reactions are the formation of oxidized products, grafts, crosslinking and scissioning of main or side chains which is also called degradation. The degree or dominance of these transformations depend on the nature of the polymer and the conditions of treatment before, during and after irradiation and close control of these factors make the modification of polymers possible by radiation processing.

Radiation induced processes have many advantages over other conventional methods. In radiation processing of polymers no catalysts or additives are required to initiate the reaction. Absorption of radiation energy by the backbone polymer initiates generally a free radical process. With chemical initiation free radicals are produced by the decomposition of an initiator into small fragments which attack the base polymer leading to free radicals. The efficiency of these two processes have been compared and estimated that the same number of initiating radicals are produced in unit time with a radiation dose rate of 1 rad/s or a chemical initiator, such as benzoyl peroxide, at a concentration of 0.1 M is used. The concentration and purity of chemical initiators are additional limiting factors, in the case of radiation processing however, the dose rate can be varied easily which makes the control of reaction more easy and better. Chemical initiation has often been associated with problems arising from local overheating of the initiator. The radiation processing however, is temperature independent, which is therefore considered as a zero activation energy process for initiation.

The polymer, plastics and rubber industries have been the beneficiaries of the unique properties and advantages of ionizing radiation for several decades and there are already a

number of very well established large scale applications of radiation processing in these industries. An excellent review has been recently published by Clough evaluating the commercial processes and new applications in this field [1].

Radiation crosslinking is an established technology in wire and cable industry, where crosslinking of insulators and sheaths imparts resistance to solvents, ageing and high temperatures. Radiation crosslinked tubings are used as hot water pipes. The production of “heat-shrinkable” packaging films, tubings and other more sophisticated devices and foams have been another well established, interesting application of radiation processing. Radiation pre-crosslinked rubber strips are used in the manufacturing of automobile tyres.

Radiation curing is commercially used on a large scale in surface finishing of coatings, lacquers and inks. For very large production units and if the formulations are opaque, heavily loaded with pigments or magnetic particles, radiation curing is of advantage.

Radiation degradation which is the opposite of crosslinking has found its greatest application in the irradiation of Teflon, which reduces the molecular weight and particle size hence allowing its use as filler for various applications.

Radiation-induced grafting is another powerful method for the modification of existing properties of a polymer and for creating of an almost unlimited range of new materials. At present only very limited commercial applications of grafting is being explored, production of battery separators from acrylic acid grafted polyethylene being the most important example.

## **Current developments**

Fifty years of research and development works in polymer radiation Chemistry has led to a number of commercial applications as mentioned very briefly in the Introduction section. Application of ionizing radiation to polymeric materials still remains to be a very active area and the polymer and plastics industry is constantly benefiting from the innovations and fruitful results obtained from the R & D works of researchers from all over the world. In the remaining part of this report a modest effort will be made to provide a survey of current developments in applied radiation chemistry of polymers and emerging new applications.

### ***Crosslinking***

The typical developments in this particular application can be highlighted as:

- *Gradient crosslinking of ultra high molecular weight polyethylene in molten state for total joint arthroplasty* — A method of producing a gradient of crosslink density across the acetabular component has been presented by a group from MIT [2]. The acetabular liners machined from UHMWPE were irradiated at 140°C in the molten state of the polymer using a 2 MeV electron beam with limited penetration of the effects of radiation into polyethylene. The gravimetric wear rate was  $27 \pm 5$  mg/million cycles using the Boston hip Simulator with the conventional liners, while the melt-irradiated acetabular liners did not show any weight loss.
- *Improvement of surface hardness of some polymers by radiation processing at high temperatures* — Gamma-ray or electron beam irradiation at high temperature and at a small dose improved the Rockwell hardness and resistance to wear for polycarbonate and polysulfone. The effective temperature during irradiation was the glass transition temperature of respective polymer, and the dose at maximum hardness was only 3-5 kGy [3]. The improvement in hardness and wear resistance was supposed to be dense

molecular packing in matrix by rearrangement of molecules with synergistic effect of radiation and temperature.

- *Irradiation of polymer blends containing a polyolefin* — Irradiation of polymer blends can be used to crosslink or degrade the desired component polymer, or to fixate the blend morphology [4].
- *Radiation vulcanization of natural rubber latex by low energy electron beams* — Use of radiation in crosslinking of natural rubber latex for the manufacturing of dipped products helped mitigating the harmful effects of sulfur vulcanization such as protein allergy, presence of nitrosamines upon incineration etc. The relatively high cost of radiation vulcanization has been overcome by using low energy electron accelerators [5].
- *Radiation crosslinking of glass fibre reinforced polyamide and polybutylene terephthalate* — Radiation crosslinking of glass fibre reinforced polyamide for industrial applications in the electrical engineering and automotive industries has become quite widespread. A radiation dose of 50 kGy is sufficient to achieve a degree of crosslinking of 70% which in practice is perfectly adequate to reach desired product properties [6]. Radiation crosslinked poly (butylene terephthalate) withstands soldering iron temperatures of 350°C which imparts thermal stability required in actual soldering processes.
- *Radiation-induced crosslinking of acetylene impregnated polymers* — Enhanced crosslinking and reduction in chain scission are found in the amorphous regions of polycrystalline polyesters, when they are irradiated in the presence of acetylene [7]. Similar effects have been observed in the crosslinking of some biopolymers which are otherwise radiation degradable.

### **Curing**

- *E-beam curing for the fabrication of fiber reinforced silicone-epoxy composites* — Gamma-ray, e-beam and photo-induced cationic ring-opening polymerizations of epoxides and vinyl ethers proceed efficiently in the presence of onium salt photoinitiators. Particularly reactive in these polymerizations are silicon-epoxy monomers containing epoxycyclohexane rings. These monomers require low doses and produce crosslinked polymers with high T<sub>g</sub> values [8]. Especially important is the demonstration of the feasibility of using low dose e-beam radiation to cure fiber reinforced epoxy-functional silicone monomers rapidly and efficiently.
- *Gamma irradiation curing of epoxy resins for structural adhesives* — Radiation cure polymerization of commercial diglycidyl ether of bisphenol F epoxy resin has been achieved using Co-60 irradiation source, compounding the monomer with an onium salt catalyst [9].
- *E-beam curing of epoxy-acrylate impregnated carbon fibers by applying braiding* — The fabric-like braided reinforcing structure was manufactured from carbon fibres by mutual irradiation of the system impregnated with epoxy-acrylate oligomer by 8 MeV e-beam which resulted in better mechanical properties than conventional curing [10].

- *Accomplishments under CRADA* — US DOE sponsored a Cooperative Research and Development Agreements (CRADA) from 1994 to 1997 in which ORNL, Sandia National Laboratory and ten industrial partners collaborated. There have been numerous noteworthy development programmes involving electron beam curable composites until 2000s [11].

### *Grafting*

- *Radiation grafting of styrene into crosslinked PTFE and sulfonation for fuel cell applications* — Proton Exchange membranes were prepared by radiation-induced grafting of styrene into crosslinked poly (tetrafluoro ethylene) films and subsequent sulfonation. The resulting membranes showed a large ion exchange capacity reaching 2.6 meq/g, which exceeds the performance of commercially available films such as Nafion [12].
- *Surface modification of nanoparticles for radiation curable acrylate clear coatings* — To obtain transparent, scratch and abrasion resistant coatings, a high content of nanosized silica and alumina filler were embedded in radiation-curable formulations by acid catalysed silylation using trialkoxysilanes [13]. These micro-fillers form efficient synergism and further enhancing surface mechanical properties by an order of magnitude. Radiation curing has shown its great potential particularly in fabricating protective polymeric composite coatings.
- *Recovery of significant metal ions from seawater and aqueous wastes by adsorbents synthesized by graft polymerization* — Polyethylene based hollow fibres and non-woven fabrics have been used to radiation graft various monomers for subsequent amidoximation to remove uranyl and vanadyl ions from seawater [14, 15].
- *Cure-grafting* — A novel radiation grafting process, termed cure-grafting, based on curing of donor/acceptor (DA) monomers as charge transfer complexes initiated by UV or any ionizing radiation source is proposed. The system is complementary to the existing pre-irradiation and simultaneous radiation grafting methods [16].
- *Development of matrices for combinatorial organic synthesis* — Radiation-induced grafting of styrene and several acrylate and methacrylate monomers onto fluoro polymers for their use as matrices for combinatorial organic synthesis which will allow solid phase synthesis to be extended to higher temperatures than are currently available with polystyrene and polypropylene based resins [17].
- *Chemically resistant self-cleaning filtration membranes* — Grafting of NIPAAm and dimethyl acrylamide onto polyvinylidene fluoride membranes to prepare chemically resistant self-cleaning membranes and drying membranes.
- *Implants for bone replacement applications* — Grafting of phosphate methacrylate esters onto fluoro polymers to enhance calcium deposition.

### *Degradation*

- *Controlled degradation of chitosan, alginates and carrageenans* — Upgrading and utilization of carbohydrates such as chitosan, sodium alginate, carrageenan, cellulose,

pectin have been investigated for recycling these bio-resources and reducing the environmental pollution. These carbohydrates were easily degraded by irradiation and various kinds of biological activities such as anti-microbial activity, promotion of plant growth, suppression of heavy metal stress, phytoalexins induction, etc. were investigated [18]. Some carbohydrate derivatives such as carboxymethylcellulose and carboxymethyl starch which are radiation degrading types, were shown to be crosslinked under certain conditions to produce biodegradable hydrogels for medical and agricultural use.

- *Microlithography* — Radiation-based technology using X rays, e-beams and ion beams is now emerging in the production of microelectronic circuits, micromachines and other small devices [1]. The conventional lithography process used for making computer chips involves patterning with light, of a thin polymer layer that is spin-coated on a silicon wafer, but this photolithography is reaching a limitation due to diffraction effects.
- *Ion-track membranes* — Ion-track membranes are used in the manufacturing of membranes which are responsive to environments such as pH and temperature. They are prepared by radiation grafting of environmentally sensitive polymers to the surface of the ion tracks. They are useful in selective separation of toxic metal ions as well as biomolecules. Organic membranes can also be converted to nanoscopic electronic devices such as conductive films, field emitters, and magnetic field sensors through hybridization with inorganic materials such as metals and semiconducting alloys [19].
- *Radiation-induced conductance in polyaniline blends* — Polyaniline one of the most promising conducting polymers is in nonconducting state when it is in base form. It can be doped to become a conductor by various techniques. An interesting approach has been the use of ionizing radiation in inducing conductivity by the HCl released from a blend of polyaniline and poly(vinyl chloride) [20]. Potential application in high dose radiation processing dosimetry has been evaluated.

#### *Biomaterials*

- *Harvesting of cell sheets from stimuli-responsive culture surfaces grafted with nanometer thick poly (N-isopropyl acrylamide)* — A novel method has been developed utilizing smart-polymer grafted surfaces for cell sheet manipulation. Electron-beam irradiation is utilized for the polymer grafting in nanometer thickness. By optimizing grafted polymer thickness, cells and cell sheets adhesion/detachment control by external stimuli such as temperature is achieved. E-beam technology is uniquely useful to prepare large amounts of stimuli-responsive culture surfaces required for tissue engineering in a simple way [21].
- *Materials for intervertebral disc replacement* — Interpenetrating polymer networks based on crosslinked poly(vinyl alcohol) were prepared by impregnating the PVA matrix with hydrophilic and hydrophobic monomers and subsequently irradiating with gamma rays [22].
- *Nanogels for various applications, drug carriers, synovial fluids, etc.* — Radiation-induced intramolecular crosslinking has been proposed as a convenient tool for the synthesis of nanogels [23]. The method has been suggested as an alternative way of

synthesizing polymeric nanogels, especially for biomedical purposes where often relatively small amounts of high-purity products are needed.

- *Metal-ion-chelated hydrogels for biotechnology applications* — Poly(N-vinyl imidazole), PVIm gels were prepared by gamma irradiation polymerization and crosslinking of its monomer in aqueous solutions. Gels loaded with Co and Cu ions in their swollen states were used for the immobilization of glucose oxidase. Loading capacity and the stability of the immobilized enzyme has been found to be very high and the residual activity was more than 90% at the end of first ten days [24].
- *Novel hydrogels* — Incorporation of natural polymers into poly(N-vinyl pyrrolidone) or poly(vinyl alcohol) based hydrogels is receiving growing attention. Especially the use of chitosan due to its inherent antibacterial properties and alginates in activating human macrophages seem to bring additional advantages into the production of wound dressings [25].

The above cited developments is by no means exhaustive and there are a number new results and applications emerging in using ionizing radiation in modifying, upgrading and shaping polymeric materials. Developments in source technologies, material handling systems, formulation of new polymeric recipes and innovative approaches will continue to bring new radiation treated products into the market.

## REFERENCES

- [1] R.L.CLOUGH, 'High-energy radiation and polymers: A review of commercial processes and emerging applications', NIM-B, 185 (2001) 8–33
- [2] O.K. MURATOGLU, D.O.O'CONNOR, C.R. BRAGDON, J. DELANEY, M. JASTY, W.H. HARIS, E. MERRILL, P. VENUGOPALAN, 'Gradient crosslinking of UHMWPE using irradiation in molten state for total joint arthroplasty', Biomaterials, 23 (2002) 717–724
- [3] T. SEGUCHI, T. YAGI, S. ISHIKAWA, Y. SANO, 'New material synthesis by radiation processing at high temperature — polymer modification with improved irradiation technology', Rad. Phys. Chem., 63 (2002) 35–40
- [4] A. SINGH, 'Irradiation of polymer blends containing a polyolefin', Rad. Phys. Chem., 60 (2001) 453–459
- [5] K. MAKUUCHI, private communication
- [6] J. GEHRING, 'With radiation crosslinking of engineering plastics into the next millenium', Rad. Phys. Chem., 57 (2000) 361–365
- [7] R.A.JONES, W. PUNYODOM, I.M.WARD, A.F. JOHNSON, 'Radiation-induced crosslinking of acetylene-impregnated polyesters', NIM-B, 185 (2001) 163–168
- [8] J.V. CRIVELLO, 'Advanced curing technologies using photo- and electron beam induced cationic polymerization', Rad. Phys. Chem., 63 (2002) 21–27
- [9] C. DISPENZA, F. SCRO, A. VALENZA, G. SPADARO, 'High energy radiation curing of resin systems for structural adhesives and composite applications', Rad. Phys. Chem., 63 (2002) 69–73

- [11] A.J. BEREJKA, C. EBERLE, 'Electron beam curing of composites in North America', *Rad. Phys. Chem.*, 63 (2002) 551–556
- [12] T.YAMAKI, M. ASANO, Y. MAEKAWA, Y. MORITA, T. SUWA, J. CHEN, N. TSUBOKAWA, K. KOBAYASHI, H. KUBOTA, M. YOSHIDA, 'Radiation grafting of styrene into crosslinked PTFE films and subsequent sulfonation for fuel cell applications', *Rad. Phys. Chem.*, 67 (2003) 403–407
- [13] H.-J. GLASEL, F. BAUER, E. HARTMANN, R. MEHNERT, H. MÖBUS, V. PTATSCHEK, 'Radiation-cured polymeric nanocomposites of enhanced surface-mechanical properties', *NIM-B*, (2003)
- [14] M. TAMADA, private communication
- [15] P.A.KAVAKLI, N.SEKO, M. TAMADA, O. GÜVEN, 'Synthesis of a new adsorbent for uptake of significant metal ions in seawater by radiation induced graft polymerization', to be published in *Polymer* (2004)
- [16] G.R. DENNIS, J.L. GARNETT, E. ZILIC, 'Cure-grafting — a complementary technique to pre-irradiation and simultaneous processes', *Rad Phys. Chem.*, 67 (2003) 391–395
- [17] D. HILL, private communication
- [18] T.KUME, N. NAGASAWA, F. YOSHII, 'Utilization of carbohydrates by radiation processing', *Rad. Phys. Chem.*, 63 (2002) 625–627
- [19] M. YOSHIDA, private communication
- [20] U.A.SEVIL, O.GÜVEN, A. KOVACS, I. SLEZSAK, 'Gamma and electron dose response of the electrical conductivity of polyaniline based polymer composites', *Rad. Phys. Chem.*, 67 (2003) 575–580
- [21] M.YAMATO, T. SHIMIZU, A. KIKUCHI, T. OKANO, 'Radiation-initiated nano-surface modification for tissue engineering', IAEA-CT, Seattle, USA, (2002)
- [22] D.DARWIS, P. STASICA, M. RAZZAK, J.M. ROSIAK, 'Characterization of poly(vinyl alcohol) hydrogel for prosthetic intervertebral disc nucleus', *Rad. Phys. Chem.*, 63 (2002) 539–542
- [23] P. ULANSKI, I. JANIK, J.M.ROSIK, 'Radiation formation of polymeric nanogels' *Rad. Phys. Chem.*, 52 (1998) 289–294
- [24] N. PEKEL, B. SALIH, O. GÜVEN, 'Activity studies of glucose immobilized onto poly(N-vinylimidazole and metal ion chelated Poly(N-vinylimidazole) hydrogels', *J. Molecular Catalysis B: Enzymatic*, 21 (2003) 273–282
- [25] A.THOMAS, K.G.HARDING, K. MOORE, 'Alginates from wound dressings activate human macrophages to secrete tumor necrosis factor-a', *Biomaterials*, 21 (2000) 1797–1802





# RADIATION POLYMERIZATION IN SOLUTION

J.M. ROSIAK

Institute of Applied Radiation Chemistry, Technical University of Lodz,  
Lodz, Poland

**Abstract.** In the recent years, an important factor stimulating research on radiation-induced reactions of polymers in aqueous solution is the application of this technique for synthesizing new materials or modifying the properties of polymers. Hydrogels are probably the most prominent examples of water-borne products obtained by radiation technology. Radiation techniques have proved to be particularly suitable for producing hydrogels for biomedical use. The main factors that contribute to the success of these technologies are: water as a human-and environment-friendly solvent, lack of any potentially harmful chemicals (monomers, initiators, crosslinking agents, etc.), simple production schemes, parallel synthesis and sterilization of the products in the sealed, final packages, valuable medical properties of the products, broad range of applications, and the possibility of manufacturing “smart” gels reacting to temperature, pH, light, etc. However, there is only limited number of successfully commercialized technologies — most of these products belong to the one category — synthetic wound dressings. The technology invented in Poland has been transferred to other member countries of the IAEA, e.g. Brazil, Egypt, Philippines, Syrian Arab Republic, Vietnam, etc. The other examples of polymers biomaterials produced using ionizing radiation have been presented. It includes drug delivery systems, new intelligent polymer support for cells cultivation, materials designed for implants as well as radiation methods for the production of nanogels- polymeric systems with intramolecular crosslinking. The results of basic studies on transformation of polymers in aqueous solution are good foundations to achieve the new technologies and biomaterials.

## Introduction

The polymerization of liquid vinyl monomers with high energy radiation has been studied since, at least, 1938. It was shown in the classical studies of Dainton and others that the mechanism was a free radical nature. However, Davidson, Pinner and Worall in 1957 successfully polymerized isobutylene in the liquid state at  $-78^{\circ}\text{C}$  with high energy radiation [1]. It is well known that “conventional” initiation is now mostly used for the preparation of polymers by polymerization (“conventional” polymerization is initiated by chemical means, i.e. with the aid of initiators or catalysts). The use of thermal and *photochemical* initiation is limited to a certain extent. The use of the former method is limited by un-favourable conditions of chain propagation at high temperatures because secondary processes occur leading to irregular, branched, or even crosslinked polymers. The use of the latter method is restricted by its low efficiency and the dependence on the optical properties of the medium.

### *Types of active centres*

Polymerization initiated by ionizing radiation can be carried out by both a free-radical and an ionic (cationic or anionic) mechanism. The determining factor is the nature of the end of the growing chain.

In monomer ionization due to Compton's effect, the electron formed can induce many secondary ionization acts.

Losing its energy after these secondary acts and thus causing the formation of numerous ions and electrons of high energy, this primary electron  $e$  is transformed into a ‘thermal’ electron  $e'$ , i.e. it attains thermal equilibrium with the medium. The thermal electron can be trapped by ions formed from monomers  $M^+$  with their conversion into activated molecules.

Subsequently, the activated monomer molecule  $M^*$ , a molecule in the excited state with an energy reserve of 8–5 eV exceeding the strength of covalent bonds in organic molecules (~3 eV), decomposes with the formation of free radicals, some of which are able to initiate polymerization.

A similar activated monomer form,  $M^{**}$ , can be generated directly from the monomer  $M$  if the radiation energy is insufficient for attaining the ionization level.  $M^{**}$  also undergoes free-radical decomposition. The probabilities of the formation of  $M^*$  and  $M^{**}$  are approximately equal.

The lifetimes of the particles formed are different. A reactive electron that is solvated (as a result of interaction with water or alcohols) exhibits the longest lifetime (up to a few microseconds). Ions are usually considered to be short-lived particles.

Until 1950s, radiation-induced polymerization was considered to proceed only by the free-radical mechanism. In fact, the rate of ion generation by ionizing radiation is one to two orders of magnitude lower than that of free-radical formation. In contrast, the recombination constants for ions (ion and counter-ion) are approximately two orders of magnitude higher than those for free radicals. Hence, the stationary concentration of ions is approximately 100 times lower than that of free radicals. Consequently, radiation polymerization proceeds mainly by a free-radical mechanism.

At present, the concepts of the formation of radical ions in the primary stages of the radiolysis of monomers containing unsaturated bonds (which constitute the main part of monomers) are widespread:

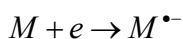

In order to detect radical ions, mass spectrometry, electron spectroscopy, and ESR are used in combination with optical bleaching. For example, according to mass spectrometric data, ethylene forms a dimer particle,  $C_4H_8$ , as a result of a primary ion-molecular reaction. This particle reacting with monomeric ethylene produces growing chains up to  $C_{14}$  with a radical-ion active centre:



Depending on the structure of the molecule of the monomer, e.g. isobutylene, the cation radicals generated as a result of radiolysis can undergo further transformations leading to an active carbocation and an inactive radical:

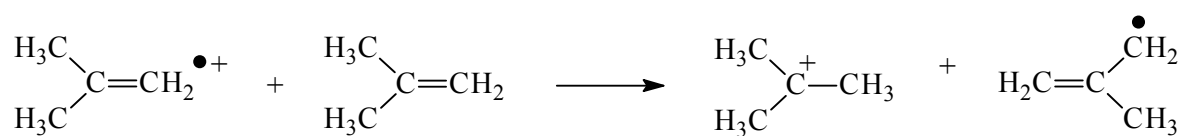

which results in initiation proceeding almost exclusively by a cationic mechanism.

It should be emphasized that ions, radicals, and radical ions ( $M^+$ ,  $M^-$ ,  $M^{\bullet+}$ ,  $M^{\bullet-}$ ,  $R^\bullet$  and  $R^\bullet$ ), intermediate and final radiolysis products capable of initiating polymerization, are extremely varied in their composition and structure.

In the radiation-chemical act, the amount of absorbed energy is generally proportional to the number of electrons per unit volume regardless of the nature of the substance filling this volume. If a monomer is irradiated, the mass spectrum may reveal not only fragmentation

products, but also particles of a higher molecular weight which are formed as a result of ion-molecular reactions.

### *Methods of radiation-induced polymerization*

Radiation-induced polymerization can be carried out in bulk, in solution, in emulsion (suspension), in the gas and solid states, and in the glassy state in other words, just as in other methods of initiation (conventional, thermal, photochemical initiation, etc.).

Principal methods of investigations of the kinetics of radiation-induced polymerization include:

*Gravimetry* is a method based on the determination of the mass of the polymer formed and the calculation of the process rate.

*Dilatometry* is a method based on the determination of changes in the volume of the reaction mixture during polymerization which result from the volume is usually determined as accurately as possible under the conditions of rigorous thermostating.

*Calorimetry* is a instrumental method based on the recording of thermal effects (heat evolution) during polymerization. This method makes it possible to follow continuously the course of the process with time and in a variable temperature field, and to record other phenomena (e.g. phase transitions) occurring in the reaction system. It is used both for the study of the process in the field of ionizing radiation and for the investigation of post-polymerization.

Apart from these methods, pulse radiolysis, ESR and NMR spectroscopy, mass spectrometry, optical, chromatographic, and luminescent methods are also used. To study the kinetics and mechanism of the reactions in the early stages of polymerization pulse radiolysis with spectroscopic detection is often used [2–4].

### **Kinetics and conditions of radiation-induced polymerization**

The great variation in the types of active centres generated in the irradiated monomer makes it possible to initiate polymerization by different mechanisms. In each specific case, the nature of the monomer determining the formation of a certain type of active centre which ensures effective initiation and the polymerization conditions, mainly the temperature and the medium (solvents), are of the greatest importance. Hence, the polymerization process usually occurs by a certain definite mechanism. Since in the course of secondary radiation-chemical transformations, in practice, particles with a longer lifetime form free radicals, the free-radical mechanism is the simplest process of radiation-induced initiation.

#### *Free-radical initiation*

In radiation-induced initiation, irradiation plays the role of initiator. The intensity of radiation, i.e. its rate, or, still more precisely, the rate of the adsorbed dose  $P_D$ , is an equivalent of the initiator concentration. Hence, the dependence of the overall polymerization rate  $v$  on the dose rate will be considered. In the initiation stage, when irradiation affects the monomer, free-radical initiation centres  $R^\bullet$  are formed. By analogy with conventional initiation we have

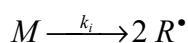

Then the initiation rate  $v_i$  is given by

$$v_i = k_i P_D \tag{1}$$

where  $k_i$  is the rate constant for the elementary initiation reaction.

Taking into account the fact that the radiation-chemical yield of free radicals from monomers, is  $G_R^M$ , it is possible to represent  $k_i$  in the following form

$$k_i = G_R^M / (100N_A)$$

It should be noted that with increasing conversion, when macromolecules formed in radiation-induced polymerization accumulate in the system, in principle as a result of radiolysis they can also form free-radical initiation centres characterized by their radiation-chemical yield  $G_R^P$ . Their effect on initiation is reflected in the equation

$$v_i = P_D (G_R^M [M] + G_R^P [P])$$

where [P] is the polymer concentration.

However, under real conditions, the value of [P] is usually neglected because in the initial stages of the process it is small.

The rate of chain propagation,  $v_p$ , is given by

$$v_p = k_p [R^{\bullet}] [M] \quad (2)$$

where  $[R^{\bullet}]$  is the concentration of macroradicals.

In the initiation stage, we have monomer radicals  $R^{\bullet}$ , whereas during chain propagation

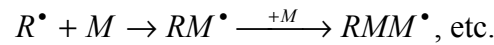

growing macroradicals,  $R^{\bullet}$  are formed. The ratio  $[R^{\bullet}]/[R^{\bullet}] = f$  expresses the initiation efficiency.

The termination rate  $v_t$  in disproportionation is described by the equation

$$v_t = k_t [R^{\bullet}]^2 \quad (3a)$$

and in recombination it is expressed by

$$v_t = 2k_t [R^{\bullet}]^2 \quad (3b)$$

Under stationary conditions, when  $v_i = v_t$ , the overall rate of free-radical polymerization is given by

$$v = v_p = k_p [R^{\bullet}] [M] \quad (4)$$

Applying Eqs (1) and (3), we have

$$k_i P_D = k_t [R^{\bullet}]^2 \quad \text{or} \quad \frac{G_R^M}{100N_A} P_D = k_t [R^{\bullet}]^2$$

$$[R^{\bullet}] = \sqrt{k_i P_D / k_t} \quad (5)$$

or

$$[R^{\bullet}] = \sqrt{G_R^M P_D / 100N_A k_t} \quad (5a)$$

Substitution of Eq. (5) into Eq. (4) gives

$$v = k_p \sqrt{(k_i / k_t) P_D} [M] \quad (6)$$

or

$$v = k_p \sqrt{G_R^M P_D / 100 N_A k_t} [M]$$

Replacing  $k_p \sqrt{k_i / k_t}$  by K (where K is a constant for the overall polymerization rate), we obtain

$$v = K P_D^{0.5} [M] \quad (7)$$

Passing to initiation related to monomer radiolysis, we have

$$-(d[M]/d\tau) = k_p / k_t^{0.5} (G_R^M P_D)^{0.5} [M]^{3/2} \quad (8)$$

The value of  $G_R^M$  in turn can be calculated from the kinetic parameters of the polymerization of the monomer M. Proceeding from Eq. (6), we obtain

$$G_R^M = 6.02 \times 10^{23} (k_t / k_p^2) (v_p^2 / [M]^2) 100 / P_D$$

The determination of constants for the elementary reactions of radiation polymerization proceeds just as for conventional free-radical initiation. We usually have  $k_p \approx 10^2 - 10^4$  and  $k_t \approx 10^6 - 10^8$  1/(mol s), i.e. just as in other initiation methods.

In polymerization in solution and termination by disproportionation, the inverse degree of polymerization is expressed by the equation

$$1/\bar{P}_n = k_t v_p / k_p^2 [M]^2 + c_M + c_S [S] / [M] \quad (9)$$

where  $\bar{P}_n$  is the number-average degree of polymerization;  $c_M$  is a constant for chain transfer to the monomer,  $c_M = k_{PM} / k_p$ ;  $k_{PM}$  is the rate constant for the interaction between the growing polymer radical and the monomer;  $c_S$  is a constant for chain transfer to the solvent,  $c_S = k_{PS} / k_p$ ; and  $k_{PS}$  is the rate constant for the interaction between the growing polymer radical and the solvent.

In the case of chain termination by recombination, the first term in Eq. (9) is multiplied by the coefficient 0.5.

In the system of coordinates  $1/\bar{P}_n - v_p / [M]^2$ , the value of  $k_t / k_p^2$  is found from the slope of the straight line, and in experiments of polymerization in bulk,  $c_M$  is determined from the intercept with the initial ordinate. In polymerization in bulk, a simpler procedure is generally used for the determination of  $c_M$ . A plot of the system of coordinates  $1/\bar{P}_n - v$  is constructed. The value of  $c_M$  is found from the intercept of the extrapolated experimental straight line with the ordinate. Since  $v_p \sim P_D^{0.5}$ , the value of  $c_M$  may be determined from a plot of  $1/\bar{P}_n$  vs.  $P_D^{0.5}$ .

The constant  $c_S$  is found by using the system of coordinates

$$(1/\bar{P}_n - k_t v_p / k_p^2 [M]^2) - [S] / [M]$$

Under stationary conditions we have

$$1/\bar{P}_n = (k_t^2 k_i f P_D)^{0.5} / k_p [M] + c_M$$

where  $f$  is the initiation efficiency. The value of  $f$  can be determined from the ratio

$$f = M_t / M_e$$

where,  $M_e$  is the experimental molecular weight ( $\overline{M}_n$ ) and  $M_t$  is the theoretical molecular weight.

$$M_t = [M]m_x / (P_D \tau)$$

where  $m$  is the molecular weight of the monomer,  $x$  is the conversion, and  $\tau$  is the time.

$k_t$  is determined directly from  $v_i$ :

$$v_i = 2k_t f P_D$$

The constants  $k_p$  and  $k_t$  are found from the ratios  $k_t / k_p^2$  and  $k_p / k_t$  determined by the pulse method under non-stationary conditions. In other words, it is a combination of  $k_p / k_t$  and  $k_p / k_t^{0.5}$ . The latter ratio is found from the equation

$$v = k_p \sqrt{v_i / k_t} [M] \quad (10)$$

The value of  $v_i$  is determined by inhibiting polymerization by adding effective free-radical inhibitors. In this case, we have

$$v_i = [X]_0 / \tau_{ind}$$

where,  $[X]_0$  is the initial inhibitor concentration and  $\tau_{ind}$  is the time of the induction period of inhibited polymerization.

Another possibility of determining  $k_p / k_t^{0.5}$  exists at low dose rate values and at termination by recombination. Applying Eq. (10) and the equation

$$\overline{P}_{n0} = 2k_p [M] / \sqrt{k_t v_i} \quad (11)$$

where,  $\overline{P}_{n0}$  is the number-average degree of polymerization in the absence of chain transfer, we obtain

$$\sqrt{\overline{P}_n} = k_p \sqrt{2 / k_t v} [M]$$

By using this equation the value of  $k_p / k_t^{0.5}$  is found from the tangent of the slope of the straight line in the system of coordinates  $\sqrt{\overline{P}_n} - \sqrt{1/v}$ . In this case,  $v_i$  is determined from Eq. (10) or (11).

*Effect of solvent.* Generally there are two reasons for the specific effect of solvents in radiation-induced polymerization: (1) the effect of the products of solvent radiolysis and (2) the redistribution of the absorbed radiation energy between the components of the monomer-solvent system.

When monomer initiation is of free-radical nature, solvents accelerate radiation-induced polymerization. Moreover, the higher the radiation-chemical yield of radicals,  $G_R^S$ , the greater is this acceleration.

In the analysis of the kinetics of radiation-induced polymerization in solution, the ratios of the polymerization rates in solution  $v_s$  and in bulk  $v_b$  determined experimentally have the following dependence on the molar fraction of the monomer  $[M]$ :

$$\frac{v_s}{v_b} = 1 + \frac{G_M^S e_S}{G_R^M e_M} \frac{1 - [M]}{[M]}$$

where  $e_S$  and  $e_M$  are the numbers of electrons in the molecules of the solvent and the monomer, respectively.

It is possible to determine the value of  $G_R^M$  from this equation.

The increase in the polymerization rate with increasing dilution of the monomer with the solvent is the sensitization phenomenon.

In the free-radical mechanism of polymerization in solution, the kinetics of the process are described by the equation

$$-\frac{d[M]}{d\tau} = \frac{k_p}{k_t^{1/2}} [M]^{3/2} [\varphi_M P_D]^{1/2} \left( 1 + \frac{\varphi_S [S]}{\varphi_M [M]} \right)^{1/2}$$

where  $\varphi_M$  and  $\varphi_S$  are constants proportional to the free-radical yield from the monomer and the solvent, respectively.

This equation is limited by the conditions that the process occurs in the stationary state and in the absence of energy transfer from S to M. This equation allows us to find

$$\varphi_S / \varphi_M, \text{ i.e. } G_R^S / G_R^M.$$

In the case of the ionic mechanism of initiation of radiation-induced polymerization, the effect of solvents may also be observed. For instance, in the polymerization of isobutylene in halogenated solvent, the product of solvent radiolysis — a halogen acid — appears. When it dissociates in a medium of high polarity, a proton is formed which accelerates polymerization. It may be assumed that a halogen acid is also formed from a halogen-containing solvent which does not contain hydrogen, e.g.  $\text{CF}_2\text{Cl}_2$ . In this case, the isobutylene hydrogen probably takes part in the formation of the halogen acid. According to another view, halogen acids are not formed when solvents that do not contain hydrogen atoms are used. However, experimental data indicate that radiation-induced polymerization is also accelerated in such solvents as  $\text{CFCl}_3$  and  $\text{CS}_2$  which do not contain hydrogen. Moreover, the polymerization rate of isobutylene in carbon sulphide is higher than that in methylene chloride.

The main features of the free-radical mechanism in radiation-induced polymerization are reported below.

- (1) The polymerization rate is proportional to the dose rate to the power 0.5;  
 $v \sim P_D^{0.5}$ . The molecular weight of the polymer is proportional to the dose rate to the power -0.5;  $M \sim P_D^{-0.5}$ .
- (2) Polymerization is inhibited by typical free-radical inhibitors: oxygen, diphenylpicrylhydrazyl, p-benzoquinone, hydroquinone,  $\beta$ -naphthylamine, etc.
- (3) The polymerization rate and the molecular weight of the polymer increase with temperature.
- (4) The values of the reactivity ratios for co-polymerization with radiation-induced initiation coincide with those obtained in conventional free-radical initiation.

#### *Calculation of the radiation-chemical yields of polymerization*

Apart from the determination of polymer yield (in %), just as in conventional polymerization, in the case of radiation-induced polymerization, the *radiation-chemical yield*  $G_p$  is used, which makes it possible to determine the radiation efficiency of the process. For

radiation-induced polymerization,  $G_p$  is usually calculated as the number of monomer molecules transformed into the polymer per 100 eV of the absorbed energy:

$$G_p = \frac{Q \times 6.02 \times 10^{23} \times 100}{q D m \times 6.24 \times 10^{15} \times 10^3} = 9.65 \times 10^6 \frac{Q}{q D m} \quad (12)$$

where,  $Q$  is the polymer yield (in g),  $q$  is the mass of the irradiated monomer (in g),  $D$  is the adsorbed dose (in kGy),  $m$  is the molecular weight of the monomer,  $6.24 \times 10^{15}$  is an equivalent of 1 Gy (in eV/g), and  $6.02 \times 10^{23}$  is the Avogadro number ( $N_A$ ).

Equation (12) will be transformed by applying Eqs (7) and (11) and taking into account that  $Q/m = \bar{P}$  if chain transfer reactions are neglected. Then the dependence of  $G_p$  on the dose rate  $P_D$  is given by

$$G_p = (\bar{v}_p / P_D) \times 100 \quad (13)$$

Substitution of the value of  $\bar{v}_p$  from Eqs (4) and (5a) into Eq. (13) gives

$$G_p = (\bar{v}_p / P_D) \times 100 = 10 k_p \sqrt{G_R^M N_A / (P_D k_t)} = k' / P_D^{0.5}$$

or

$$G_p = k' P_D^{-0.5}$$

This dependence of  $G_p$  on the dose rate shows that in polymerization, the use of high dose rates which are achieved in irradiation by fast electrons greatly decreases the efficiency of the process. Hence, it is necessary to compare the values of  $G_p$  for different processes at the same rate of the absorbed dose.

The ratio of  $G_p$  to  $G_R^M$  gives the average value of the kinetic chain  $\bar{v}$ :

$$\bar{v} = G_p / G_R^M$$

In termination by disproportionation,  $\bar{v} = \bar{P}_n$ , and in recombination termination

$\bar{v} = \bar{P}_n / 2$ . Hence, in disproportionation we have

$$\bar{M}_n = \bar{P}_n m = (G_p / G_R^M) m = 10 k_p m \sqrt{N_A / (P_D G_R^M k_t)} = \bar{P}_n / \sqrt{G_R^M P_D}$$

and in recombination

$$\bar{M}_n = 2\bar{P}_n m = 2(G_p / G_R^M) m = 20 k_p m \sqrt{N_A / (P_D G_R^M k_t)} = 2\bar{P}_n / \sqrt{G_R^M P_D}$$

From these equations one may determine, in particular,  $G_R^M$  from the data of number-average molecular weight and  $G_p$  at a given type of termination.

The orders of magnitude of the values of  $G_p$  (molecules/100eV) for real processes of radiation-induced polymerization of different monomers are very different, e.g. diene hydrocarbons  $10$ - $10^2$ , whereas tetrafluoroethylene  $10^5$ - $10^6$ .

The expression of radiation-chemical consumption of the monomer  $G_{(M)}$  is sometimes used instead of the radiation-chemical polymer yield  $G_p$ , their calculations being similar.

In order to characterize the efficiency of radiation-induced initiation, the value of  $G_i$  is used. It is calculated from the data on the initiation rate  $v_i$  and is expressed by the number of



reactive chains formed per 100 eV of the adsorbed energy. Approximately (in the absence of chain-transfer reactions) we have

$$G_i = G_p m / \overline{M}_n = G_p / \overline{P}_n$$

More precisely, taking into account chain transfer (non-degrading transfer) to the monomer  $c'_M$  and neglecting chain transfer to the solvent under the conditions of constant dose rate and constant concentration of additives and impurities,  $G_i$  is calculated as follows.

The dependence of  $1/\overline{P}_n$  on  $1/[M]$  is plotted applying the equation

$$1/\overline{P}_n = c_M / k_p + 1/(k_p [M] \tau)$$

where,  $\tau$  is the lifetime of the kinetic chain, and  $k_p \tau$  is determined. Then using this value, we find  $G_i$  according to the equation

$$G_i = G_p / (k_p \tau [M])$$

### *Ionic polymerization*

Before formulating the main features of the ionic mechanism in radiation initiation, we will consider the general concepts ensuring an ionic polymerization mechanism.

The ability of a monomer to polymerize according to a certain mechanism (or several mechanisms) is known to be determined mainly by its nature. In radiation-induced polymerization, some definite conditions should also be obeyed.

First, suitable monomers are required for radiation-induced polymerization proceeding by a *cationic mechanism*. Isobutylene, vinyl ethers, cyclopentadiene and  $\beta$ -pinene polymerize only by a cationic mechanism, whereas  $\alpha$ -methyl styrene polymerizes by both cationic and anionic mechanisms. Second, it is necessary to use the conditions of the existence of ions  $M^+$  ( $M \rightarrow M^+ + e$ ) and the stabilization of secondary electrons capable of neutralizing  $M^+$ . This is achieved (a) by carrying out polymerization at low temperatures when the lifetime of ions increases and the activity of free radicals drastically decrease, and (b) by using electron-accepting solvents or additives.

Ethyl chloride, methylene chloride, difluorodichloromethane, tetrafluoromethane, etc. are generally used as solvents for cationic polymerization. For the quantitative characterization of electrophilic (electron acceptor) and nucleophilic (electron donor) solvents, acceptor (AN) and donor (DN) numbers, respectively, are proposed.

The acceptor number is based on the measurement of the signal shift in  $^{31}\text{P}$ -NMR spectra in the interaction of triethylphosphine with a given solvent in a dilute solution. Electron-accepting solvents (acceptors) exhibiting electrophilic character are characterized by the acceptor number AN arbitrarily taken to be 0 for hexane and 100 for  $\text{SbCl}_5$  in dichloroethane. The acceptor numbers of some solvents are given below:

	<i>AN</i>
Hexane	0
Tetrachloromethane (carbon tetrachloride)	8.6
Dichloroethane	20.4
Chloroform	23.1
Water	54.8

Solution of stibium pentachloride SbCl <sub>5</sub> in dichloroethane	100.0
Trifluoroacetic acid	105.3
Methylsulphonic acid, CH <sub>3</sub> SO <sub>3</sub> H	126.1
Trifluoromethylsulphonic acid, CF <sub>3</sub> SO <sub>3</sub> H	129.1

Zinc, calcium and magnesium oxides, silica gel, and other compounds are used as solid additives in radiation-induced polymerization carried out by a cationic mechanism. Recently, Crivello shown that very useful for electron-beam induced cationic polymerization are onium salts, which presence in the systems allow to achieve high conversion of monomers at very low doses [5, 6].

For carrying out polymerization by *an anionic mechanism*, the conditions of electron acceptance by the monomer should exist:

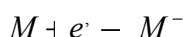

This is achieved by using monomers of the corresponding nature (nitroethylene and vinylidene cyanide are polymerized only anionically, whereas acrylonitrile and methyl methacrylate polymerize by both anionic and free-radical mechanisms) and by carrying out polymerization in solvents whose molecules contain electron-donating groups (atoms) or an unshared electron pair (dimethyl formamide, triethylamine, isopropylamine, tetrahydrofuran, acetone, ethylpropyl ketone, etc.).

Donor solvents can react with acceptors of the electron pair, and their donor number is determined by the enthalpy (taken with the opposite sign) of the reaction of addition of a given molecule to stibium pentachloride.

The characteristic of solvents from the viewpoint of their nucleophilicity is given below:

Solvent	DN
1,2-Dichloroethane	0
Benzene	0.1
Dioxane	14.8
Acetone	17.0
Ethyl acetate	17.1
Diethyl ether	19.2
Tetrahydrofuran	20.0
Trimethyl phosphate	23.0
Dimethyl formamide	26.6
N-Methyl-2-pyrrolidone	27.3
Dimethyl sulphoxide	29.8
Diethyl formamide	30.9
Water	~ 33
Pyridine	33.1
Hexamethylphosphotriamide	38.8
Hydrazine	44
Ethylenediamine	55
Ethylamine	55.5

tert-Butylamine	57.0
Ammonia	59.0
Triethylamine	61.0

The path to anionic initiation probably passes via the reaction of free radicals with secondary electrons:

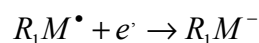
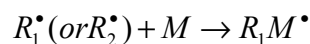
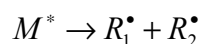
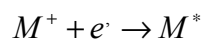
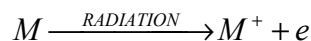

If the monomer can polymerize by free-radical and ionic mechanisms, then by varying the conditions (temperature and nature of solvent) it is possible to ensure a predominant or even selective polymerization mechanism.

#### *Kinetics of ionic polymerization*

No general rate equation is known to exist for the processes of ionic polymerization, but if we restrict ourselves to the case relatively typical of ionic processes, when reactions of kinetic termination are absent and initiation proceeds rapidly, the polymerization rate may be expressed in the form

$$v = k P_D^n [M]$$

where  $n = 1$ , i.e. in ionic polymerization, the exponent of the rate of the absorbed dose is often observed.

However, in practice, deviations from this relationship often occur and usually depend on the purity of the monomer. With increasing monomer purity, the value of  $n$  increasingly approaches 0.5 even for processes that without doubt occur by the ionic mechanism. This fact, which seems surprising at first, is due to the specific features of radiation-induced initiation. As already mentioned, the initiating particles are monomer ions ( $M^+$  or  $M^-$ ) without counterions. Apart from the formation of free ions in radiolysis, secondary processes of the capture of a thermal electron by monomer or solvent molecules also occur, which leads to a free solvated anion. Since the contents of ions of the same sign are equal, their neutralization is expressed by bimolecular termination and leads to  $n = 0.5$ . Then we have  $R_1^+ + R_2^- \rightarrow P$

$$v_p = k_p \sqrt{v_i / k_t} [M]$$

This stage can also happen earlier if electroneutral impurities, e.g. water, are present in the system. In this case, termination on this admixture is a monomolecular reaction, and the exponent is equal to unity. This equation makes it possible to evaluate the propagation rate constant  $k_p$  for the free-ion process of radiation-induced polymerization. The values of  $v_i$  and  $k_t$  are determined, for example, by varying the electrical conductivity of the monomer in the radiation field.

Hence, in ionic radiation-induced polymerization the exponent of the rate of the absorbed dose can vary from 0.5 to 1.0 depending on the termination mechanism. Moreover, this order is an indication of the purity of the reaction system. A conclusion follows which is

important for the recommendations on the use of electron accelerators as sources of radiation at a high dose rate: in the processes of ionic polymerization, the effect of impurities decreases with increasing absorbed dose. Hence, it is possible to carry out the ionic polymerization of monomers that are not completely dried and purified at a high dose rate with electron accelerators.

In ionic polymerization in bulk, the degree of polymerization is expressed by the equation

$$\bar{P} = k_p / c_M$$

and for polymerization in solution

$$\bar{P} = k_p / (c_M + c_S [S] / [M])$$

or

$$1/\bar{P} = c_M / k_p + c_S [S] / k_p [M]$$

The latter expression can be easily plotted in the system of coordinates  $1/\bar{P} - [S]/[M]$ ; the ratio of the constant for chain transfer to the solvent to the propagation constant,  $c_S/k_p$ , is calculated from the slope of the straight line, and the ratio of the constant for chain transfer to the monomer to the propagation constant,  $c_M/k_p$ , is determined from the intercept of this straight line with the ordinate.

The main features of the ionic mechanism in radiation-induced polymerization are given below.

- (1) The polymerization rate is proportional to the dose rate to the power of unity. The monomer purity plays an important role in ionic polymerization, and the exponent of the dose rate is profoundly affected by it, being 0.5 for "super-pure" monomers.

When the effect of impurities on radiation-induced ionic polymerization is considered, two points should be taken into account. One of them is related to the concentration limit of impurity, which affects the reaction order in dose rate, depends on the nature of the impurity, and is low. For instance, the presence of  $10^{-2}$  mol/l of water in the reaction system can suppress the cationic polymerization of styrene.

Hence, the value of the exponent  $n$  is a very tentative indication of the mechanism for radiation-induced polymerization, and other factors should be known for the precise establishment of this mechanism.

- (2) The molecular weight of the polymer is independent of the dose rate:

$$P \sim P_D^0 [M]^{1.0}$$

It is known that in the polymerization of 1,3-butadiene by the ionic (cationic) mechanism which has been proven by the microstructure of the resulting polymer, the molecular weight of the polymer remains constant with the variation in the dose rate.

- (3) The process is suppressed by typical inhibitors of cationic (substances containing atoms with an unshared electron pair: pyridine, amines, DMF, ketones, alcohols, nitriles) or anionic (ethyl chloride and acetonitrile) polymerization. Water, methanol, and ammonia are universal ionic inhibitors which affect radical processes only slightly.
- (4) The values of the apparent activation energy are negative or close to zero. For an ionic mechanism,  $E$  is usually  $-4$  to  $-12$  kJ/mol. These values indicate that with decreasing temperature the polymer yield, and hence the rate of ionic polymerization, increases.

An ionic mechanism is usually effectively revealed in the range of negative temperatures. However, if adequately purified and dried monomers and solvents are used and the reaction vessel is thoroughly cleaned, an ionic mechanism is also observed at temperatures above 0°C (up to 30°C).

### **Main features of radiation-induced emulsion polymerization**

*Emulsion polymerization* is known to be a method of carrying out polymerization in a disperse system in which water is usually the dispersion medium. In order to ensure the stability of an emulsion containing 30-60% of the monomer, *emulsifiers* are used. They are compounds of diphilic type: surfactants which decrease the surface tension at the hydrocarbon-water interface. This decrease facilitates the emulsification of the monomer in water and favours the stabilization of the emulsion.

Polymerization starts in the micelles of the emulsifier, because a considerable part of the monomer is dissolved in its hydrocarbon moiety. At 13-20% conversion of the monomer, emulsifier micelles are completely destroyed, and the emulsifier passes into the adsorption layer on the surface of polymer particles. Polymerization continues in the polymer-monomer system, i.e. in a latex into which the monomer penetrates by diffusion from drops.

Apart from emulsion polymerization, in practice *suspension polymerization* is also used. This process occurs directly in the monomer drop with the formation of a solid polymer in the form of grains. Therefore this polymerization is also called *bead or gram polymerization*.

In contrast to conventional initiation in which an initiator soluble in water and insoluble in the monomer is used, radiation initiation proceeds under the influence of radiations.

Under correctly chosen conditions (mainly an appropriate emulsifier), the radiation-chemical yield of emulsion polymerization attains very high values. For instance, if sodium lauryl sulphate is used for the radiation-induced emulsion polymerization of methyl methacrylate, we have  $G_p \approx 10^5$ , and for that of butyl acrylate,  $G_p \approx 10^6$  molecules/100 eV.

The efficiency of radiation emulsion polymerization is much higher than that for polymerization in bulk or in suspension: conversion and the molecular weight of the polymer increase by one to two orders of magnitude. This increase results from the formation of additional radicals in water (increase in  $G_R$ ) and a decrease in the termination rate.

Hence, in order to ensure a relatively high rate of radiation-induced polymerization in the emulsion, low dose rates (0.1-1 Gy/s) and low absorbed doses are required. For all these reasons, radiation emulsion polymerization is particularly advantageous from an economical standpoint. Its activation energy, just as for other processes of radical radiation-induced polymerization, is 15-35 kJ/mol. The molecular weight of polymers increases with temperature, as in the case of typical free-radical processes (to a certain extent). This increase is due to an increase in  $k_p$  with temperature, whereas  $k_t$  does not depend on the temperature.

By varying the reactors (glass or metal reactors) and emulsifiers (cation-active or anion-active emulsifiers) after polymerization it is possible to obtain systems in the following forms: a latex, a separated polymer layer attached to the reactor walls, or a power-a thin polymer layer on metal. This variation is probably due to the recharging of latex particles caused by ionizing radiation. It is preferable to use enameled metal reactors.

Apart from the advantages of radiation emulsion polymerization indicated above and those characteristic of radiation-induced polymerization in general, the following advantages should also be mentioned.

- (1) When post-polymerization occurs, a very monodisperse polymer is obtained, and conversion may attain 100%.
- (2) Since ionizing radiations stabilize the emulsion system because a charge is generated in the dispersed particles, emulsifier consumption is two to three orders of magnitude lower (down to 0.04%) than in conventional initiation, and the emulsifier is recycled.
- (3) There is no need to purify waste-water because after the isolation of the polymer this water can be recycled. This is very important from economical and ecological standpoints because the problem of sewage treatment in industry in emulsion polymerization is very complex.
- (4) Polymers of extremely high molecular weight are obtained (for instance, up to  $2 \times 10^7$  for polystyrene). Hence, they exhibit high strength and thermal stability but are difficult to process. Some physico-mechanical characteristics are given below for emulsion polystyrene obtained by  $\gamma$ -initiated post-polymerization (I) and by polymerization with conventional initiation (II):

	I	II
Bending strength (MPa)	0-80	37.5-50
Tensile strength (in the oriented state) (MPa)	4.7	0.8
Temperature range of the highly elastic state	100-200	90-150

Polyacrylonitrile synthesized by radiation emulsion polymerization is used for manufacturing high tenacity fibres.

#### *Carbon dioxide as solvent*

During recent years, the use of supercritical carbon dioxide as reaction medium has seen a rapid growth, primarily due to the need to develop environmentally acceptable alternatives to conventional organic solvents in a wide range of processes, including polymerization.

CO<sub>2</sub> offers many advantages over conventional solvents because it is non-toxic, non-flammable, inexpensive and readily available. Moreover, CO<sub>2</sub> presents a relatively low critical temperature (31.1 °C) and moderate critical pressure (7.4 MPa) and as with all supercritical fluids (scFs), it offers mass transfer advantages due to its low viscosity and surface tension.

When CO<sub>2</sub> is considered as a polymerization medium, its solvent strength towards the reagents and the products is of major concern. Carbon dioxide is a low dielectric solvent, which behaves with good approximation like a hydrocarbon solvent for what concern the solubility of volatile non-polar molecules of low molar mass. On the other hand, it is a weak Lewis acid and it has a significant quadrupole moment which gives a significant contribution to its solubility parameter thus allowing it to dissolve some polar molecules such as methanol. As a result, CO<sub>2</sub> is a good solvent for most vinyl monomers but is an exceedingly poor solvent for most high molar mass polymer. The only classes of polymers which have exhibited good solubility in scCO<sub>2</sub> under relatively mild conditions (T < 100°C, P > 35 MPa) are amorphous fluoropolymers, silicones and polyether-polycarbonate copolymers [7].

Owing to this solubility consideration, carbon dioxide has been used as a free-radical homogeneous polymerization media only for highly fluorinated amorphous polymers while

heterogeneous techniques have been adopted in the case of non-fluorinated monomers both precipitation and dispersion polymerization of vinyl monomers.

Effective surfactants in CO<sub>2</sub> are amphipatic macromolecules containing an anchoring segment (the so-called lipophilic anchor) that became adsorbed on the surface of the polymer phase by grafting and/or physical adsorption, and a stabilizing portion that is soluble in the continuous medium. The stabilizing moiety is usually constituted by a fluorinated or silicone chain.

The advantages of a dispersion polymerization process can be coupled with the peculiarity of the ionizing radiation to give reactive species that start polymerization processes in the absence of initiators or catalysts in the system, thus leading to the formation of a very pure product [8,9]. The use of the ionizing radiation allows carrying out the process in CO<sub>2</sub> near-critical conditions with a significant reduction in the operating pressure and with a clear advantage from the technical point of view.

### *Living polymerization*

In an ideal case, there are mechanistically only two steps, initiation and propagation in a living polymerization. Initiation is followed by propagation as long as monomer is present in the polymerization system, and addition of a new charge of monomer (or a second monomer) leads to further propagation. There are no chain breaking reactions, such as termination or chain transfer, and after consumption of the initiating species, only propagation occurs. In other words, all the chains formed by initiation are in active form, i.e. all the growing chain ends are permanent "living" chain carriers for propagation during polymerization at any time. This is illustrated in Scheme 1. Two general types of initiation are exhibited in this scheme: in a two-step process, the initiator is first transformed to a reactive species which is able to interact with the monomer to start polymerization, while in a one-step initiation the initiator directly reacts with the monomer leading to the propagating species. After initiation is complete, only propagation occurs with  $k_p$  rate constant.

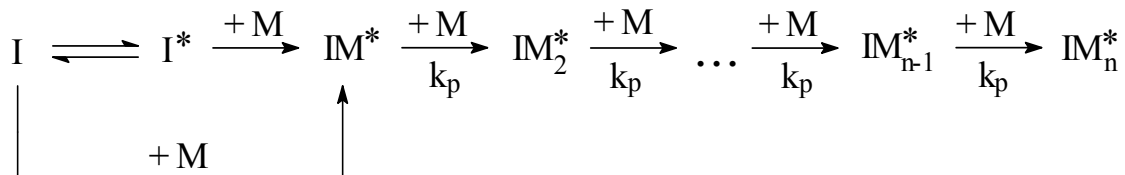

*Scheme 1. The model of ideal living polymerization.*

If the rate of initiation is higher than the rate of propagation, then the concentration of propagating chains ( $[P^*]$ ) is equal to the initiator concentration ( $[I]_0$ ) after the consumption of the initiator. Therefore the rate of polymerization ( $v$ ) is given by the following equation:

$$v = k_p [I]_0 [M]$$

where,  $[M]$  is the concentration of monomer.

Ideal living polymerization is a most desired process since it offers a wide range of opportunities for obtaining polymers with well-defined structure and molecular weights, and in many cases, narrow molecular weight distributions. However, by analyzing the existing

living polymerization systems which meet the required experimental criteria, or at least the majority of them, one can conclude that ideal living polymerization is a very rare process. It is likely that only anionic polymerization of olefins, such as styrene, in polar solvents belongs to this category. In the majority of living polymerizations, only a portion of chain ends are active (propagating) and these are in equilibria with inactive (dormant, nonpropagating) chains as experimental and conclusive evidences indicate [10].

*Reversible addition-fragmentation chain transfer (RAFT)* polymerization has proven to be a powerful tool for the synthesis of polymers with predetermined molecular weight and low polydispersity [11, 12]. In recent years, synthesis of polymers with complex molecular architecture, e.g. block and star copolymers, via the RAFT process have been reported [13].

Davis et al. [14] in an elegant review on the RAFT technique discuss thiocarbonylthio compounds to mediate the polymerization via a reversible chain-transfer process. This leads to the establishment of equilibrium under which all the propagating chains have approximately the same chain length at the same instant of time. A large class of chain transfer agents that are applied in RAFT polymerizations have the general formula:

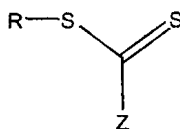

*Scheme 2. Dithioester RAFT agent — general formula.*

These RAFT agents must include a good leaving group (R) that is able to re-initiate polymerization and a Z-group that strongly influences the stability of the intermediate disulfur macroradical species.

The proposed reaction mechanism for RAFT polymerization under a constant source of  $\gamma$ -radiation is shown in Scheme 3. The basic steps of the RAFT mechanism are extended by reaction steps that effect grafting onto polymeric surfaces.

In this scheme, initiating radicals are generated via the application of  $\gamma$ -radiation. Radicals can be formed at polymeric surfaces and in the monomer solution (reaction steps (I) in Scheme 3). Monomer radicals and radicals formed on the surface initiate propagating chains, which subsequently add to the thiocarbonyl group in the thiocarbonylthio-compound (II), creating the RAFT radical intermediate (2). In addition, radicals generated on the polymeric surface are also capable of adding to the initial RAFT agent. These reaction steps summarized under (II) have been termed the pre-equilibrium. In the pre-equilibrium the leaving group radicals R are released from the initial RAFT agent and subsequently re-initiate macromolecular growth in the reaction step (IIIb). The core of the RAFT process is the main equilibrium given by the reaction steps (IVa) and (IVb). Within this core process, free macro radicals that are either attached to the polymeric surface or are free to move in the surrounding reaction mixture, are adding to polymeric RAFT agent to form macroRAFT intermediate radicals (species (4) in Scheme 3), which in turn may fragment by releasing the starting materials or the formerly attached polymeric entity. Reaction step (V) gives the bimolecular termination reactions between free or surface attached macro radicals.



(I)  $\gamma$ -Initiation

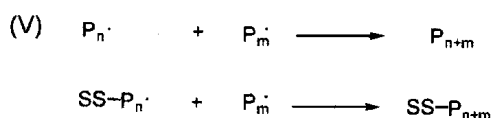
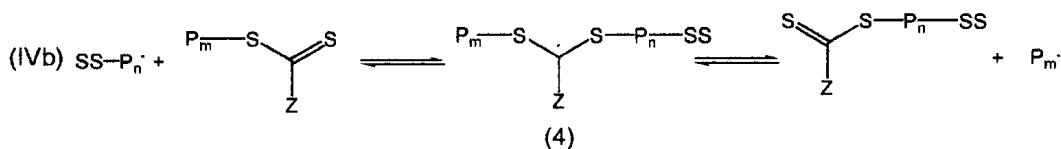
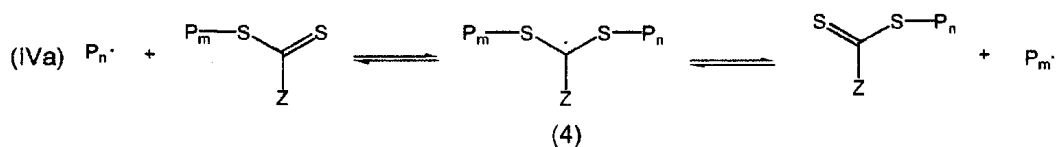
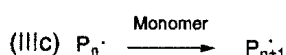
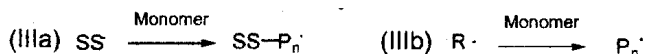
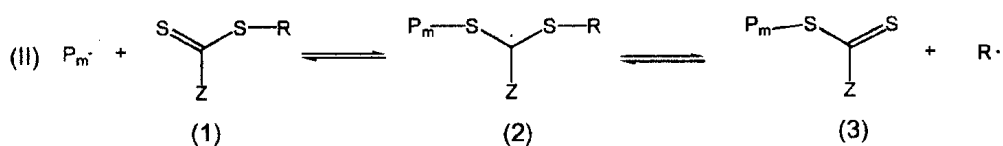
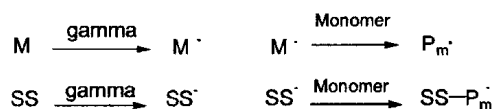

Scheme 3. Possible RAFT mechanism for  $\gamma$ -initiated polymerization and grafting onto polymeric solid surfaces [14]

Living polymerization under a constant source of  $\gamma$ -radiation in the presence of thiocarbonylthio compounds was first reported in 2001 by Pan and co-workers [15, 16]. Scheme 4 shows the mechanism used by these authors to account for the living behaviour observed under a constant source of  $\gamma$ -radiation. Under this scheme,  $\gamma$ -radiation induces sequential homolytic cleavage of the carbon sulfur bond in the dithioester, yielding a stable thiocarbonylthiyl radical. The other half of the thiocarbonylthio compound ( $R^1$ ) initiates polymerization, and the resulting chains are then reversibly terminated by the stable radical. Pan and co-workers base this mechanism on the fact that the thiyl group of the  $Z-C(S)-S-$  is always attached to the head of the monomer. However, this explanation cannot differentiate between the two mechanisms, as polymers generated via RAFT will share the exact same structure.

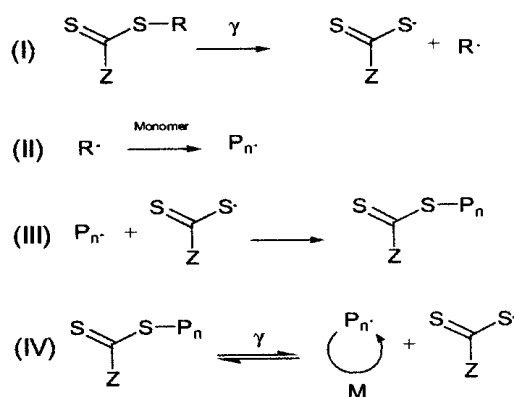

Scheme 4. Schematic mechanistic representation of reversible termination polymerization [14]

### Advantages and defects of radiation-induced polymerization

The *advantages* of the radiation-chemical method of initiation are as follows:

(1) The possibility of polymerizing monomers which are difficult to polymerize by conventional methods. In particular, this group comprises some fluorine-containing compounds forming valuable thermally stable and chemically resistant polymers, monomers with a symmetrically substituted double bond, and allyl monomers. For some of them, radiation-induced initiation is the only possible method of initiating polymerization.

(2) The ease and efficiency of carrying out polymerization in the solid state and the polymerization of channel and layer inclusion compounds. Penetrating radiation, in particular  $\gamma$ -radiation, ensures regular initiation throughout the bulk of the solid monomer.

(3) The preparation of polymers of exceptionally high purity containing no residues of initiators, catalysts, or other supplementary compounds inevitably present in the polymer when polymerization is carried out by usual procedures and greatly deteriorating its service properties. This is of particular importance for polymers used in electronics and medicine. In order to improve the quality of polymers obtained by conventional polymerization, they should be freed of impurities, which complicates the technology of polymer synthesis and increases the cost. In radiation-induced initiation, the polymer is pure because in this case initiation is carried out by a fragment of the monomer molecule of the same chemical nature.

(4) Radiation-induced initiation makes it possible to vary the polymerization temperature over an extremely wide range. The process may be carried out at high or medium rates at usual or low temperatures in those cases where the application of initiators or catalysts requires higher temperatures. Favourable conditions are thus attained for polymer chain propagation and the formation of macromolecules with minimum branching. Hence, the properties of the polymer materials improve.

(5) Radiation-induced polymerization differs from the usual methods in that there is more reliable reaction control. In conventional initiation, the polymerization rate decreases with increasing consumption of the initiator (catalyst), and, in the case of an exothermic process, with a rise in temperature, initiator dissociation is accelerated, which leads to the irregularity of the process. In contrast, upon irradiation the analogous temperature rise hardly affects the concentration of free radicals or ions initiating polymerization, their concentration being determined mainly by the rate of the adsorbed dose (radiation intensity). By varying this power it is possible to polymerize systems containing large amounts of inhibiting impurities, thus stopping their action. The efficiency of initiation and, hence the output, can be greatly increased. Consequently, radiation-chemical initiation makes it possible to obtain more

precise polymerization control during any required period of time, which is difficult to achieve in conventional initiation.

(6) It is possible to carry out polymerization “on site” for manufacturing polymer parts in hard-to-reach places (‘embedded; gaskets, non-removable parts, etc.).

(7) Higher process rates and economy of operating areas (under the conditions of local protection) as compared with the traditional polymerization process. For example, in the manufacture of a light-transmitting glass-reinforced plastic in rolls based on a co-polymer of methyl methacrylate and styrene, the economy of the operating area is about one order of magnitude, and the process rate increases greatly.

The following *disadvantages* of the radiation-chemical method of initiation should be pointed out.

(1) Equipment difficulties, mainly caused by stringent requirements of safety engineering in processes in which ionizing radiation is applied and by the necessity of obtaining a regular field of dose rate in the reaction zone and for the most advantageous utilization of the radiator.

(2) The possibility of the occurrence of secondary processes under the influence of ionizing radiation: crosslinking or degradation of the polymers being formed and the radiolysis of monomers.

It should be noted that in principle these defects can be eliminated.

The former defect is eliminated in many cases by finding corresponding engineering solutions and automating the production, e.g. by carrying out the process according to a continuous scheme with the removal of the polymer from the radiation zone. The latter defect can be eliminated by selecting optimum polymerization conditions. However, in some cases, this defect may be regarded as an advantage of radiation-induced polymerization when it is desirable to combine in a single process the preparation and crosslinking of chain polymers.

## REFERENCES

This report was compiled on the basis of the book entitled Radiation Chemistry of Polymers written by Ivanov V.S. (1992, VSP, Utrecht, the Netherlands) and following cited articles:

- [1] STANNET V.T., Radiation Induced Ionic Polymerization and Grafting of Vinyl Monomers, The British Polymer Journal, (1981), 93–98.
- [2] TAKACS E., DAJKA K., WOJNAROVITS L., EMMI S.S., Pulse radiolysis study of the initial steps of the polymerization of cyclohexyl acrylate and cyclohexyl methacrylate. Radiat. Phys. Chem., (2002), 63, 485–488.
- [3] TAKACS E., DAJKA K., WOJNAROVITS L., Study of high-energy radiation initiated polymerization of butyl acrylate. Radiat. Phys. Chem., (2002), 63, 41–44.
- [4] KUJAWA P., ULANSKI P., ROSIAK J.M., Time resolved investigation of pulse-initiated polymerization. Radiat. Phys. Chem. (1998), 52, 389–393.
- [5] CRIVELLO J.V., UV and electron beam-induced cationic polymerization. Nucl. Instr. and Meth. in Phys. Res. B, (1999) 151, 8–21.
- [6] CRIVELLO J.V., Advanced curing technologies using photo- and electron beam induced cationic polymerization. Radiat. Phys. Chem. (2002), 63, 21–27.

- [7] SARBU T., STYRANEK T.J., BECKMANN E.J., Non-fluorous polymers with very high solubility in supercritical CO<sub>2</sub> down to low pressure. *Nature*, (2000), 405, 165–168.
- [8] CAPUTO G., GALIA F., SCRO F., SPADARO G., FILARDO G., Gamma radiation induced polymerization of vinyl monomers in dense CO<sub>2</sub>. *Radiat. Phys. Chem.*, (2002), 63, 45–51.
- [9] FILARDO G., CAPUTO G., GALIA A., CALDERARO E., SPADARO G., Polymerization of methyl methacrylate through ionizing radiation in CO<sub>2</sub>-based dense systems. *Macromolecules*, (2000), 33, 278–283.
- [10] BELA I., Comparison of living polymerization systems. *Macromol. Symp.* (1994), 88, 201–215.
- [11] CHIEFARI J., CHONG F., ERCOLE F., KRSTINA J., JEFFERY J., LE TPT ET AL., Living free-radical polymerization by reversible addition-fragmentation chain transfer: the RAFT process. *Macromolecules*, (1998), 31 (16), 5559–62.
- [12] MAYADUNNE R.T.A., RIZZARDO E., CHIEFARI J., CHONG Y.K., MOAD G., THANG S.H., Living radical polymerization with reversible addition-fragmentation chain transfer (RAFT polymerization) using dithiocarbamates as chain transfer agent. *Macromolecules*, (1999), 32 (21), 6977–80.
- [13] STENZEL-ROSENBAUM M., DAVIS T.P., CHEN V., FANE A.G., Star-polymer synthesis via radical reversible addition-fragmentation chain-transfer polymerization. *J. Polym. Sci., Part A: Polym. Chem.* (2001), 39 (9), 1353–65.
- [14] BARNER L., QUINN J.F., BARNER-KOWOLLIK C.H., VANA P., DAVIS T.P., Reversible addition-fragmentation chain transfer polymerization initiated with  $\gamma$ -radiation at ambient temperature: an overview. *European Polymer Journal*, (2003), 39, 449–459.
- [15] BAI R.K., YOU Y.Z., ZHONG P., PAN C.Y., Controlled polymerization under <sup>60</sup>Co  $\gamma$ -irradiation in the presence of dithiobenzoic acid. *Macromol. Chem. Phys.*, (2001), 202 (9), 1970–3.
- [16] HONG C.Y., YOU Y.Z., BAI R.K., PAN C.Y., BORJIHAN G., Controlled polymerization of acrylic acid under <sup>60</sup>Co  $\gamma$ -irradiation in the presence of dibenzyl trithiocarbonate. *J. Polym. Sci., Part A: Polym. Chem.*, (2001), 39 (22), 3934–9.

# RADIATION-ASSISTED COMPATIBILIZATION OF POLYMERS

T. CZVIKOVSKY

Department of Polymer Engineering, Budapest University of Technology and Economics,  
Budapest, Hungary

**Abstract.** Temporary engineering materials became gradually more and more complex in their composition and structure. The multiple functions required today in our machine parts and other applications demand this complex structure, consisting of different components, all contributing with their best features. This multicomponent approach is dominant in the polymer engineering field in systems such as

- copolymers,
- compounds, blends and alloys,
- composites, and
- recycling of multicomponent materials.

Radiation processing may help to overcome theoretical and technological difficulties, in the way of creating new multicomponent polymeric systems. In the present work, we focused on solving the major obstacle, the inherent thermodynamical incompatibility of partners in polymer blends, alloys, composites and recycled products.

Radiation-assisted compatibilization may promote the common use of synthetic and natural polymers in multicomponent engineering polymers. This type of compatibilized material multicomponent may easily be processed by the plastics machinery of today. It certainly will gain importance when renewable natural products of the biomass should participate at an accelerated rate in saving the fossil (petroleum) resources.

Radiation treatment applying reactive additives may broaden the field of radiation cross-linking of polymers, which are non-cross-linkable without reactive additives.

Radiation-assisted compatibilization of multicomponent, recycled polymer systems may turn the recycling procedures of our day — which are rather directed toward down-cycling, — into an upgrading procedure: up-cycling.

Radiation-initiated bonds of the interface between reinforcement and matrix offer a superior quality in high-tech composite systems.

## Introduction

The contemporary engineering materials became gradually more and more complex in their composition and structure. The multiple functions required today in our machine parts and other applications demand this complex structure, using different components, all contributing with their best features. This multicomponent approach is dominant in the polymer engineering field in systems such as

- copolymers,
- compounds, blends and alloys,
- composites and
- recycling of multicomponent materials.

Radiation processing may help to overcome theoretical and technological difficulties, in the way of creating new multicomponent polymeric systems. In the present work we focus on solving the major obstacle, the *incompatibility* of partners in polymer blends, alloys, composites and recycled products.

After clarifying the basic definitions, we shall discuss the inherent, *thermodynamical incompatibility* by mixing polymers. We will survey the conventional solutions of compatibilization, and then we treat some recent achievements of radiation compatibilization in the field of blending, composite processing and recycling.

The *copolymerization*, where different monomers are built in the same backbone of polymer chain, is governed by the specific reactivity of the participating monomers. Alternating-, block- or random copolymers are manufactured this way in large commercial scale [1]. Where those individual reaction rate constants - differing too much, - do not allow monomers to build in the same main chain, radiation initiated *graft copolymerization* helps to bring together extremely different polymer features [2, 3].

In the polymer engineering we call *compounds* those intimate solid mixtures in which the technical polymer material for a specific application contains all the necessary additives - e.g. plasticizers, lubricants, impact modifiers, heat stabilizers, antioxidants, flame retardants, colorants, etc. — making the material suitable for the given task. A typical PVC compound e.g. for a window profile, consists of 8 – 10 components [4].

Polymer *blends* are aiming to bring together different polymers completing each others favorable properties. A typical task is to improve the toughness of an otherwise suitable, but too rigid engineering polymer, by blending in another polymer having higher impact strength. Physical mixing in melts of two randomly selected thermoplastics, without creating chemical bonds is however limited by inherent incompatibility in most cases, — as we will see it below [5].

The target of *alloying* is just to reach a suitable level of compatibility, realized already thousands of years ago in multicomponent metallic systems. The *composite* principle is refreshed in the last century: a reinforcing phase is embedded in a matrix material, improving greatly the “ensemble” set of properties, offering the advantage of the built-in, pre-designed anisotropy, required in most engineering construction [6].

In blends, alloys, composites and even in the multicomponent recycled polymers an extremely important, specific role is played by the *interface* between the components. Here is, where radiation processing offers a very specific tool of engineering [7].

### **Inherent incompatibility of polymers**

The binary mixture of (two) polymers is considered a compatible blend, when a homogeneous solid system is formed, without phase separations. It means a complete mutual solubility of the two polymers in molten state as well. This compatibility is reflected in — among other physical and mechanical properties, — the fact that the system will have one single glass transition temperature ( $T_g$ ). This miscibility of the most important thermoplastics in binary systems is seen on Fig. 1 [8].

	PS	SAN	ABS	PA	PC	PMMA	PVC	PP	PE-LD	PE-HD	PET
PS	1										
SAN	6	1									
ABS	6	1	1								
PA	5	6	6	1							
PC	6	2	2	6	1						
PMMA	4	1	1	6	1	1					
PVC	6	2	3	6	5	1	1				
PP	6	6	6	6	6	6	6	1			
PE-LD	6	6	6	6	6	6	6	6	1		
PE-HD	6	6	6	6	6	6	6	6	1	1	
PET	5	6	5	5	1	6	6	6	6	6	1

FIG.1. Miscibility of common thermoplastics [8]

Notion: 1- readily miscible ..... 6 - sparingly miscible (practically incompatible)

As it is seen in Fig.1, between the 55 different binary mixtures of the most common 11 thermoplastics — representing more than 90% of the plastics production today, — only in 7 cases is founded a complete miscibility (notion 1). On the other hand, in more than 87% of the cases, the polymers are more or less incompatible. This phenomenon may be attributed to structural, thermodynamical causes.

As the Gibbs law of free energy describes, the change of the free energy in the mixing process ( $\Delta G_{mix}$ ) is depending on the enthalpy change ( $\Delta H_{mix}$ ) and the entropy change ( $\Delta S_{mix}$ ) according to the following formula

$$\Delta G_{mix} = \Delta H_{mix} - T \cdot \Delta S_{mix}.$$

To achieve good miscibility, there are two conditions to be fulfilled:

$$\Delta G_{mix} = \Delta H_{mix} - T \cdot \Delta S_{mix} < 0$$

and

$$\left[ \frac{\delta^2 \Delta G_{mix}}{\delta \Phi_2^2} \right]_{T,P} > 0.$$

Those are the conditions to reach a lower, more stable position of the free energy.

This is seen in Fig. 2.

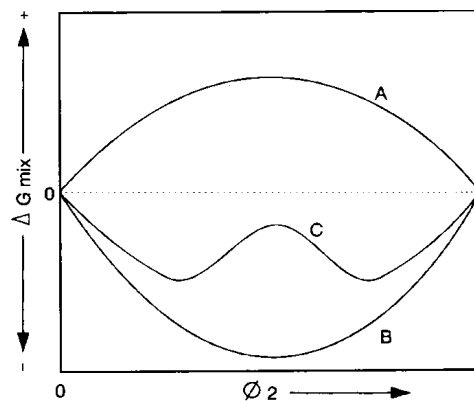

FIG.2. Different routes of free energy changes in function of the concentration of the second component in binary polymer mixtures [8]

A - incompatible, B - compatible, C - partially compatible mixtures

In Fig. 2, it is clearly visualized, that in case A — which describes the situation in more than 80% of the cases, — there is no gain in free energy by mixing. That is the thermodynamical reason of the most frequent, inherent incompatibility.

There is an enormous industrial interest to combine the best properties of the different polymers by improving their compatibility, creating real alloys instead of partially or totally immiscible blends. Some of the early alloys e.g. the ABS-PC (quite miscible) blend has been a great industrial success, reaching up to the body panels of American automobiles (e.g. *Saturn* of the GM). The task is to obtain the greatest possible interaction between the polymers to be mixed

- by selecting optimum chemical composition,
- by adding suitable compatibilizers,
- by carrying out ‘in situ’ bonding reactions,
- through grafting and/or (partial) cross-linking.

The first two ways are operating with physical, secondary bonding forces, the last two methods of compatibilization are reactive ways. Radiation processing is capable to form chemical bonds between the components, promising higher efficiency.

Chemical compatibilizers are commercially offered in growing amount in our time. These are amphoteric chemical agents of double-face character. They are molecules equipped with

- hydrophil – hydrophobe, or
- polar – apolar, or
- crystalline (liquid crystalline) — amorphous chain ends, assuring good connections through H-bonds and other type of secondary forces.

Tables Ia and Ib show some commercially available compatibilizers. The main problem with those compatibilizers is that they are often aggressive, hazardous chemicals, expensive and dangerous, not only unfriendly to the environment, but also corrosive to the plastics processing machines and molds.

### **Compatibilization by radiation treatment without additives**

Radiation, as a non-selective, highly efficient tool of ionization may form excited sites, ions and free radicals in almost all kind of materials. Radiation treatment of polymer mixtures, even if they are (partially) incompatible, gives a chance for bridge-forming bonds. Gisbergen and Overbergh [9] surveyed the radiation effects on polymer blends. They have found substantial benefit of radiation in two types of blends. Radiation cross-linkable dispersed phase (PE) may interact positively with a degrading matrix (PP). On the other hand, cross-linkable dispersed phase such as PE may also interact with radiation-insensitive polymer, like PS. In that case a protective action of PS has been observed. By irradiating blends of PP and EPDM, with a modest dose of 44 kGy, a very significant increase of impact strength has been observed, while other mechanical properties have not been decreased (see Table II).

Similar compatibilization has been achieved through radiation, without any specific additives, involving recycled and virgin PET and radiation oxidized HDPE [10].



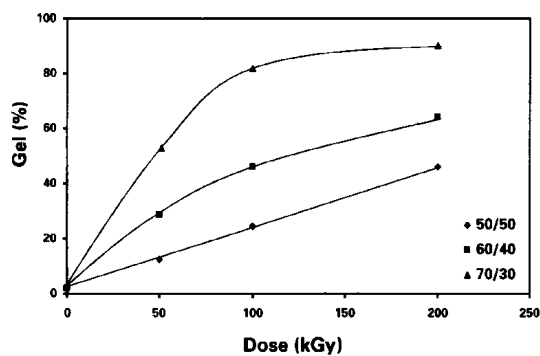

FIG.3. Gel content of radiation treated HDPE/PET blends [10].

TABLE Ia. COMMERCIAL POLYMER COMPATIBILIZERS AND THEIR APPLICATION [8]

Copolymer	Trade Name	Manufacturer	Recommended application
Styrene/maleic anhydride	Cadon SMA	Monsanto ARCO	Polystyrene, ionomers, PVC
Ethylene/maleic anhydride	EMA	Monsanto	Polymers with amine end groups, polyamides, etc.
Higher olefin/maleic anhydride	Polyanhydride	Gulf	Polymers with amine end groups, polyamides, etc.
Ethylene/maleic anhydride	Lotrene	CdF Chemie	Polyamides, ionomers
Ethylene/ethylene vinyl acetate/ unsaturated acids	Plexars Elvax 4000 Orevacs CXA Resin	Chemplex Du Pont Atochem Du Pont	Polyamides, ionomers
Ethylene/alkyl acrylate/ maleic anhydride	Lotader	CdF Chemie	Polyamides, ionomers
Ethylene/alkyl acrylate/ unsaturated acids	Vamac	Du Pont	
Ethylene/alkyl acrylate/ unsaturated acids	Lupolen A2910	BASF	Polyamides
Ethylene/acrylic acid	Primacor	Dow	Polyamides, ionomers
Ethylene/acrylic acid salt	Escor	ESSO Europe	Polyesters
Ethylene/methacrylic acid	Elvax II Nuerel	Du Pont	Polyesters
Ethylene/methacrylic acid salt	Surlyn		
Chloropolypropylene	Parion P	Hercules	NBR, PP, PO/elastomer blends
Chloropolyolefin	CP Resin	Eastman Dow	NBR, PP, PO/elastomer blends
Polyamides/polyolefin	Solar RB and PA	Du Pont	PO/PA blends
Chloropolyethylene	CBE Pybrin	Dow	
EPDM, sulphonated	Ionomeric elastomer	Uniroyal	PP/Acrylic rubber blends
PE, sulphonated	Hypalon	Du Pont	
Natural rubber, low molecular carboxylated	Hycar	BF Goodrich	} Reaction with other functional groups in polymer
Natural rubber, low molecular, amine end groups	Hycar	BF Goodrich	
Polybutadiene, carboxylated	Hycar CIB	BF Goodrich	

TABLE Ib. COMMERCIAL POLYMER COMPATIBILIZERS AND THEIR APPLICATIONS [8]

Copolymer	Trade Name	Manufacturer	Recommended application
Polychloroprene, carboxylated	Denka LCR	Denki KKK	Polyamides, polychloroprene
Polysulphide rubber, thiol end groups	Thiokol LP	Thiokol-Morton	Polyamides, polychloroprene
Polyetheramide oligomers (aminated)		Atochem	Reaction with ionomer, carboxylated polymers
Polypropylene/graft acrylic acid	Polybond 1001-4	BP	PO, PA, NBR
Polypropylene, graft copolymer with acrylic acid	PP Liant	Atochem	PO, PA, NBR
Polyethylene/vinyl acetate/graft acrylic acid	Polybond 106	BP	PO, PA, NBR
Polyethylene/graft acrylic acid	Polybond 107	BP	PO, PA, NBR
Polypropylene/EPDM/graft acrylic acid	Polybond 106	BP	Improvement of adhesion to PP/EPDM blends
EPDM/graft acrylic acid	Polybond 100A	BP	PA
PE-LLD/graft acrylic acid	Polybond 94-723	BP	PO/elastomer blends
PE-HD/graft acrylic acid	Polybond 107A	BP	PE-HD/elastomer blends

TABLE II. MECHANICAL PROPERTIES OF IRRADIATED PP/EPDM BLEND

**Table 4.3 Mechanical Properties of Injection Molded PP/EPDM 70/30 Blends [24]**

Polymer blend <sup>b</sup>	Properties <sup>a</sup>			
	NIRT (kJ/m <sup>2</sup> )	$\sigma_y$ (N/mm <sup>2</sup> )	E (N/mm <sup>2</sup> )	$\epsilon$ (%)
PP-H/EPDM (44 kGy)	57.3	17.2	804	597
PP-L/EPDM (0 kGy)	8.1	16.4	828	460

<sup>a</sup> NIRT = izod impact strength at room temperature,  $\sigma_y$  = yield stress, E = Young's modulus,  $\epsilon$  = elongation at break; <sup>b</sup> PP-H, high molecular weight PP; PP-L, low molecular weight PP.

A number of similar compatibilization research results have been surveyed in a recent work of ours [11].

### Compatibilization by radiation and reactive additives

The principle of the radiation-initiated compatibilization may be upgraded by adding some reactive additives to the multicomponent system before or after the radiation step. The advanced procedure may be considered as a kind of sensitized cross-linking. The result is clearly a diminishing of required radiation dose, achieving the same or better level of compatibilization as without additives.

The reactive additives applied in this procedure are typically vinyl monomers and/or oligomers, with one or more double bond, capable of radiation initiated chain reactions. The reactive additives — applied in moderate concentrations, — may form short side-chains and this way cross-linking bridges between the components to be compatibilized. The whole process may also be considered as promoted cross-linking, or graft - cross-linking.

From our earlier results [12] we take as an example the difficult task to compatibilize a polymer system of containing

- PP homopolymer (49 parts),
- Wood fiber (30 parts),
- Chopped glass fiber (20 parts) and
- Reactive oligomer (1 parts)

The whole mixture — as a dry blend — has been irradiated on air by a modest dose: 8 kGy of Electron Beam, and then extruded, granulated and injection molded. The results of the mechanical tests are more than convincing: a substantial increase is due to the radiation assisted compatibilization.

The commercial application of natural fiber reinforced composite systems compared on Table IV is extremely rapidly growing in the automobile manufacturing. Figure 4 shows the conceivable applications for natural fiber reinforced composite in a typical European passenger car [12]. Similar application can be designed in commercial heavy transporter (see Fig. 5).

TABLE III. RADIATION ASSISTED COMPATIBILIZATION OF MULTIPHASE POLYMER SYSTEM [10].

<b>Composition (weight part)</b>				
PP homopolymer	100	100	49	49
Wood fiber	–	–	30	30
Chopped glass fiber	–	–	20	20
Reactive additive	–	1	1	1
EB dose [kGy]	–	8	–	8
<b>Properties</b>				
Tensile strength [MPa]	32.1	36.6	39.3	54.9
Tensile modulus [GPa]	1.48	2.90	5.71	6.87
Flexural strength [MPa]	36.8	40.6	54.4	84.1
Flexural modulus [GPa]	1.20	1.42	4.10	4.99
Impact strength [J/m]	15.6	20.7	19.1	22.3
Heat tolerance at 1 GPa [°C]	51	51	119	129
Heat tolerance at 0.25 GPa [°C]	122	122	160	161
MFI 230°C/2.16 kg, g/10 min	19.2	27.5	2.9	8.3

TABLE IV. COMPARISON OF EB TREATED AND COMMERCIAL WOOD FIBER PP COMPOSITES

	Samples <sup>a</sup>				
	WFRP-S	WFRP-R	WFRP-T	GOR	ICI
Composition: <sup>b</sup>					
Polypropylene (%)	63.25	56.75	31.65	60	60
Wood fibers (%)	35	35	35	40	40
Rubber (%)	--	--	31.6	--	--
Copolymer (%)	--	6.5	--	--	--
Reactive additive (%)	1.75	1.75	1.75	--	--
Electron-beam dose (mutual) (kGy)	5	10	10	0	0
Flexural strength (MPa)	62.5	46.3	21.7	43.5	31.3
Flexural modulus (GPa)	3.46	4.35	1.82	2.86	2.17
Tensile strength (MPa)	48.8	36.1	20.8	24.2	19.3
Tensile modulus (GPa)	3.89	3.79	1.05	3.38	2.68
Impact strength (notched Izod) (J/m)	11	12	32	--	--
Melt flow index (g/10 min.)	4.4	4.2	--	1.0	0.3
Thermal expansion coefficient (10 <sup>6</sup> /°C)	18.1	--	--	--	--
Heat distortion temperature					
at 1.85 N/mm (°C)	116	69	31	100	--
at 0.46 N/mm (°C)	146	--	--	--	--
Thermal tolerance <sup>c</sup> (°C)	142	102	63	--	52
Mold shrinkage (%)	--	0.71	--	--	--

<sup>a</sup> WFRP-S = composite designed for high strength; WFRP-R = composite designed for high modulus or rigidity; WFRP-T = composite designed for high impact strength or toughness; GOR = Italian commercial material from GOR Company; ICI = British commercial material from ICI Company.

<sup>b</sup> Copolymer: Profax XSV-945; rubber: Nordel 2744.

<sup>c</sup> Thermal tolerance is the temperature at which the flexural modulus equals 1 GPa.

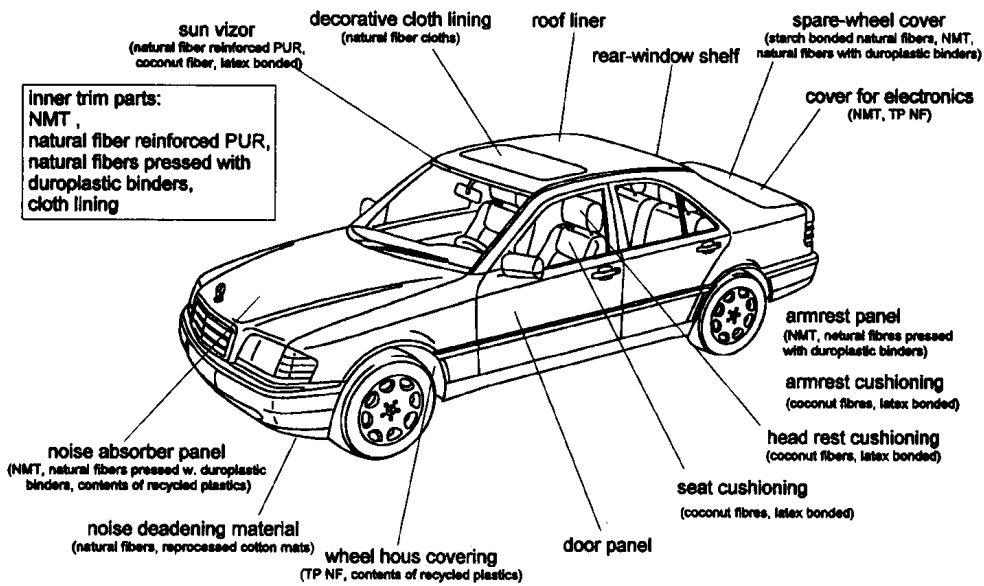

FIG. 4. Conceivable applications of natural fiber reinforced polymer composites in cars (NMT=natural fiber mat reinforced thermoplastic; TP NF=natural fiber reinforced thermoplastic)

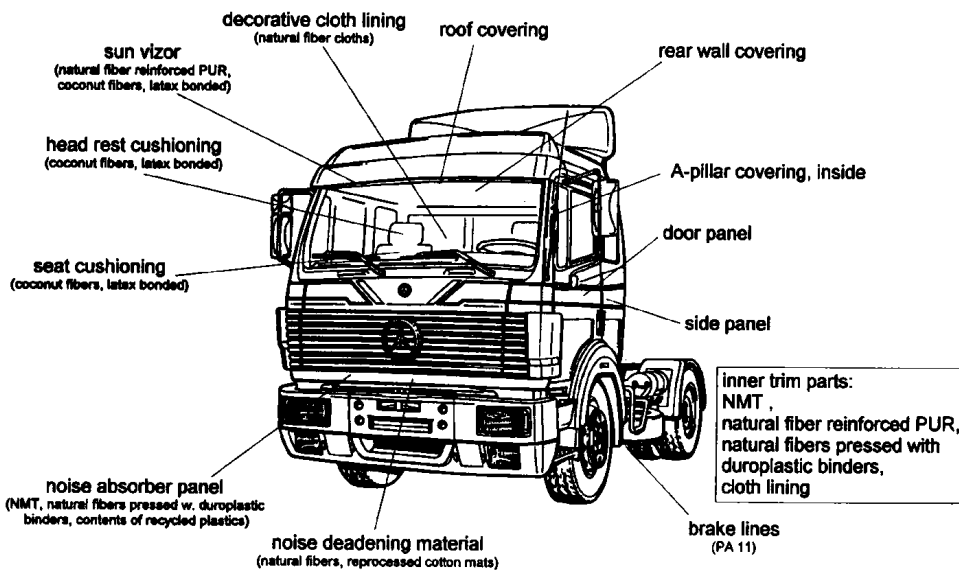

FIG. 5. Conceivable applications of natural fiber reinforced polymer composites in commercial heavy trucks (NMT=natural fiber mat reinforced thermoplastic; TP NF=natural fiber reinforced thermoplastic)

## Radiation-assisted composite processing

The concept of radiation-assisted composite processing is applied recently to recycle post-consumer PET materials of soft drink bottles, the consumption of which is approaching 5 Mtons/year worldwide [14]. Here, the expected results have not been achieved in tensile strength, with the same modest dose (10 kGy) and 2% of epoxy acrylate as reactive additive. A significant increase (30 – 50%) has been obtained however in bending strength and impact resistance, in presence of 10% chopped glass fiber, — as related to the values of the recycled PET material. The recycled thermoplastic PET composite is well suitable for injection molding of technical parts. Actually the reuse of the re-granulated PET waste is directed toward second-grade textile fibers, used as filler in hidden non-woven structures. The radiation may help in the valuable recycling instead of down-cycling today.

Finally, I would like to show some recent results of our laboratory in the field of EB processed carbon fiber composites. On the basis of the new Hungarian-made carbon fiber, a specific reinforcing structure has been elaborated applying a well known textile technology: the braiding. Pipe and other hollow profile composite products can be manufactured this way, by applying EB curing. The fabric-like braided reinforcing structure has been elaborated by using CF roving of 48000 elementary fibers. Conventional chemical curing and radiation curing of the epoxy acrylate matrix has been compared by testing mechanical properties of the final composite tubes and profiles [15].

Figures 6, 7 and 8 show the interlaminar shear strength, the bending modulus and the bending strength of the composites in function of the EB dose, as compared to the chemical curing. 120–180 kGy of EB dose was required for reaching optimum properties. The increased mechanical strength, specifically the more than 50% improved shear strength between fiber and matrix is clearly demonstrating again the efficient bonding achieved through radiation compatibilization.

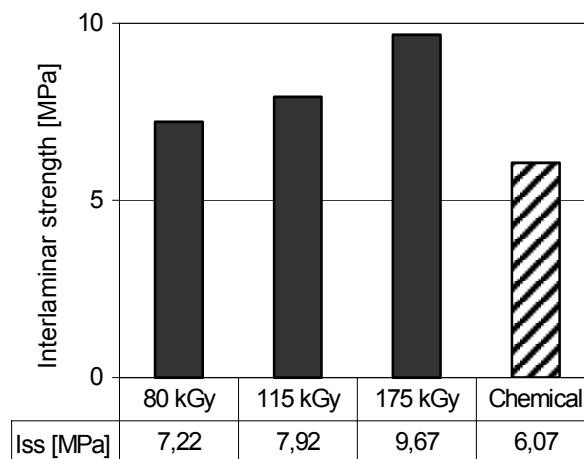

FIG. 6. Interlaminar strength measured in the composite wall.

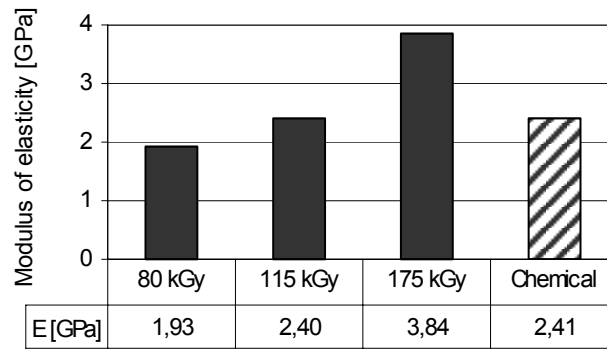

FIG. 7. Bending modulus of the composite wall.

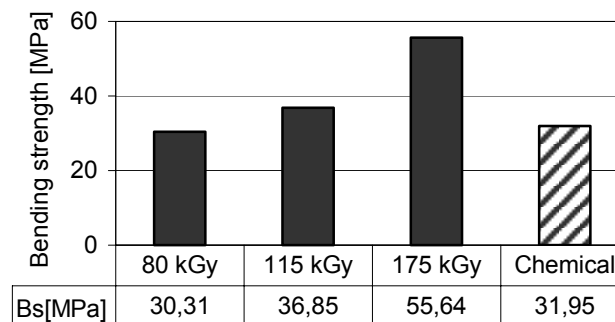

FIG. 8. Bending strength of the composite wall.

Our laboratory working, teaching and investigating mainly on conventional technologies of polymer engineering is deeply convinced about the growing significance of polymer composite systems. We also assume a strong trend in the future — as we approach the civilization of sustainable development — the renewable polymers should participate more and more in multicomponent polymer systems to save fossil resources [16, 17].

Our target: to develop polymer blends alloys and reinforced composites containing natural components such as wood fiber, flax, sisal, etc fibers, corn hull, and basalt fibers — which is a kind of natural origin. Actually we are working on such composites in most of cases, starting from scratch, using conventional no-radiation methods. That is serving the base line. However, it is clear from the beginning, that a good cooperation, adequate adhesion between such different components requires an engineered compatibilization. Radiation offers a very efficient tool for that engineering work on blends, alloys, composites of natural and synthetic polymers, as well as “activating” and recycling of commingled polymers.



## Conclusions and future outlooks

- Radiation-assisted compatibilization may promote the common use of synthetic and natural polymers in multicomponent engineering polymers. This type of compatibilized materials may easily be processed by the plastics machinery of today. It certainly will gain importance when renewable natural products of the biomass should participate at an accelerated rate in saving the fossil (petroleum) resources.
- Radiation-assisted compatibilization may broaden the field of radiation cross-linking of polymers which are non cross-linkable without reactive additives.
- Radiation-assisted compatibilization of multicomponent, recycled polymer systems may turn the recycling procedures of our day - which are rather directed toward down-cycling, - into an upgrading procedure: up-cycling.
- Radiation-initiated bonds of the interface between reinforcement and matrix offer a superior quality in high-tech composite systems.

## REFERENCES

- [1] RODRIGUEZ F., Principles of polymer systems, Hemisphere Publ., New-York, 1989.
- [2] DOBÓ J., SOMOGYI Á., CZVIKOVSKY T., Grafting of styrene onto Teflon and polyethylene by preirradiation, J.Polymer Sci., **C4**, 1173 – 1193, 1963.
- [3] YAMAKI T., ASANO M., ET AL., Radiation grafting of styrene into crosslinked PTFE films for fuel cell applications, Radiat. Phys. Chem., **67**, 403 – 407, 2003.
- [4] GAECHTER R., MÜLLER H., KLEMCHUK P.P., Plastics additives handbook Hanser, Oxford Univ. Press, Munich, New York, 1990.
- [5] CZVIKOVSKY T., Principles of polymer engineering (Univ. textbook, in Hungarian) Műegyetem kiadó, Budapest, 2000.
- [6] GAY D., HOA S.V., TSAI S.W.. Composite materials: design and applications, CRC Press, Boca Raton, 2003.
- [7] CZVIKOVSKY T., Expected and unexpected achievements and trends in radiation processing of polymers, Radiat. Phys. Chem. Phys., **67**, 437 – 440, 2003.
- [8] BRANDRUP J., BITTNER M., ET AL., Recycling and recovery of plastics, Hanser – Gardner, Munich – Cincinnati, 1996.
- [9] GINSBERGEN J., OVERBERGH N., Radiation effects on polymer blends, in: Radiation processing of polymers (eds: SINGH A., SILVERMAN J.) Hanser – Oxford Univ. Press, Munich – New York, 1992.
- [10] BURILLO G., HERRERA-FRANCO P. ET AL., Compatibilization of recycled and virgin PET with radiation-oxidized HDPE, Radiat. Phys. Chem., **63**, 241 – 244, 2002.
- [11] BURILLO G., CLOUGH R., CZVIKOVSKY T., ET AL., Polymer recycling: potential application of radiation technology, Radiat. Phys. Chem., **64**, 41 – 51, 2002.
- [12] WITTIG, W.R., The use of natural fibers in vehicle components, In: Plastics in automotive engineering, (ed: HALDENWANGER, H.G.), Hanser – Gardner, Munich – Cincinnati, 1994.

- [13] CZVIKOVSKY T., Reactive recycling of multiphase polymer systems by electron beams, *Nucl. Instruments and Methods* **B 105**, 233 – 237, 1995.
- [14] TÓTH K., CZVIKOVSKY T., MEDHAT A.E., Radiation-assisted PET recycling with glass fiber reinforcement and reactive additives, *Radiat. Phys. Chem.*, **68** (in press) 2003.
- [15] ZSIGMOND B., HALÁSZ L., CZVIKOVSKY T., EB processing of carbon fiber reinforced braided composites, *Radiat. Phys. Chem.*, **67**, 441 – 445, 2003.
- [16] SZABÓ J. S., ROMHÁNY G., CZIGÁNY T., KARGER-KOCSIS J., Interpenetrating vinylester/epoxy resins reinforced by flax fiber mat, *Advanced Composites Letters*, **12**, 113-118, 2003.
- [17] SZABÓ J. S., CZIGÁNY T., Investigation of static and dynamic fracture toughness of short ceramic fiber reinforced PP composites, *J. Macromol. Sci.*, **B41**, 1191–1204, 2002.

# NANOPOLYMERS AND RADIATION

M. LAVALLE

Institute for the Organic Synthesis and Photoreactivity (ISOF)  
of the National Research Council (CNR),  
Bologna, Italy

**Abstract** Ionizing radiation has been found to be widely applicable in modifying the structure of polymers and a significant advantage of the use of radiation is that the processes can be considered “solvent free” respect to conventional synthesis procedures thereby reducing or avoiding the presence of additives that could be potentially harmful. The use of radiation has involved, as might be expected, the field of nanotechnologies in the production of new materials and structures that have both fundamental interest and potential applications in areas such as biomedical sciences, electronics, optics, and material sciences. Metal sulphide semiconductors of nanometric dimensions in polymer matrices are realized using gamma irradiation of a suitable solution of monomer, sulphur and metal sources, and they find applications in photoluminescent, photoelectric and non-linear optic materials. Ion track membranes, obtained by chemical etching of heavy ion irradiated polymer films, find application as templates for the synthesis of nanostructures. The shape of the pores can be modified, obtaining asymmetric pores, which rectify an ion current, and temperature sensitive pores can be obtained by grafting of others polymers on the membranes.

## Introduction

Ionizing radiation has been found to be widely applicable in modifying the structure and properties of polymers, and can be used to tailor the performance of either bulk materials or surfaces. Currently, there is a large interest in nanoscale materials since they have both fundamental interest and potential applications in areas such as biomedical sciences, electronics, optics, material sciences. New researches involve, as might be expected, the use of the radiation in the field of nanotechnologies.

In this review, some of the topics related to this aspect are shortly presented:

- metal sulphide semiconductors/polymer nanocomposites;
- ion track membranes.

## Metal sulphide semiconductors/polymer nanocomposites

Metal sulphide semiconductors/polymer nanocomposites are considered to be highly functional materials with many applications, such as in photoluminescent, photoelectric and non-linear optical materials. The flexibility and processability of polymer matrices can provide good mechanical properties.

In general, two basic routes have been used to synthesize the composites. One is to carry the inorganic reaction between metal ion sources with H<sub>2</sub>S or organometallic sulphur sources inside the polymer matrices. The other is to polymerize the monomer after doping the inorganic semiconductor components inside. In the above traditional methods, the dispersion of metal sulphide is difficult to control since the inorganic reaction and polymerization are performed separately, and semiconductors could not be well dispersed in the polymer matrix.

A novel strategy to synthesize spherical semiconductor/polymer assemblies in a heterogeneous solution system by  $\gamma$ -irradiation is reported in literature [1]. In this system, an

organic monomer with polar groups can self-organize into micelle-like aggregates with inner hydrophilic region, utilizing the difference of the solubility of different fragments in the monomer molecule. Such micelle-like aggregates can polymerize to polymer spheres with inner hydrophilic region under  $\gamma$ -irradiation, the latter can act as both the template and non-reactor for the following growth of inorganic semiconductor nanoparticles or nanofibers. In this approach,  $\gamma$ -irradiation offers an ideal means, by which both polymerization of the monomer aggregates and the further growth of the inorganic nanofibers occur at room temperature and under ambient pressure.

The  $\gamma$ -irradiation method has been used to prepare spherical assemblies of 10x50nm CdS nanofibers in poly(vinyl acetate) sphere with diameter of 120nm by irradiating a heterogeneous system with the upper layer of vinyl acetate monomer and carbon sulphide and the under layer of aqueous cadmium chlorite solution. The irradiation reaction between cadmium chloride and carbon sulphide, and the polymerization of monomer vinyl acetate occur in this one-pot system during the irradiation, leading to the formation of spherical assemblies of semiconductor in polymer and the resulting CdS nanofibers with a good crystallinity. By an appropriate control of the experimental parameters, this technique could be extended to the preparation of a variety of spherical assemblies of semiconductor in polymer in heterogeneous systems under  $\gamma$ -irradiation at room temperature and in ambient pressure.

Several assemblies of metal sulphide semiconductors/polymer nanocomposites have been realized by using this method:

- PbS/polyacrylonitrile nanocomposite which consists of quasi-spherical PbS particles of 8nm in diameter, homogeneously dispersed and well separated in the polymer matrix. The polyacrylonitrile was chosen, being a good heat-insulator and an aging-resistive material. To provide an homogeneous system, in which the reactants are well mixed at the molecular level, and to ensure the presence of solvated electrons, absolute ethanol was used as solvent [2];
- CdS nanofiber/poly(styrene-alt-maleic anhydride) composites with CdS particles with diameter < 5nm and lengths in the range 70-100 nm [3];
- ZnS nanowires in an inverted hexagonal liquid crystal formed by oligo(ethylene oxide)oleyl ether amphiphiles, n-hexane, n-hexanol/i-propanol (2:1), and water. The final product consists of ordered nanowires with a diameter of about 5 nm [4].

### **Ion track membranes**

Track-etch membranes (TM) offer distinct advantages over conventional membranes due to their precisely determined structure. Their pore size, shape and density can be varied in a controllable manner so that a membrane with the required transport and retention characteristics can be produced. The use of heavy ion accelerators made it possible to vary LET of track-forming particles, angle distribution of pore channels and pore lengths. So far the track formation and etching process has been studied in much detail for several polymeric materials. Today the understanding of determining factors and the numerous empirical data enable the manufacturing of particular products based on polyethylene terephthalate (PET) or polycarbonate (PC) films. Pore shape can be made cylindrical, conical, tunnel-like, or cigar-like at will. A number of modification methods has been developed for creating TMs with special properties and functions. Nuclear trackpores find diverse applications as model systems and as templates for the synthesis of micro- and nanostructures [5].

The template-base method consists of filling a host porous medium with one or many desired materials. Although different porous media can be considered, track-etch templates present several advantages partially linked to their production process. This two step process consists of an irradiation of a polymer layer or a film by energetic heavy ions creating linear damage tracks, followed by a chemical etching of these tracks to pores. Sometimes one or two intermediate steps such as thermal treatment or light track sensitisation are added to provide new characteristics to the templates, such as, for example, the creation of pores only in well-distributed areas of the template (patterning). Such track-etch templates enable the synthesis of wires or tubules with a well-controlled size and shape and exhibiting a small roughness and a large aspect-ratio: sizes from 10 nm to several  $\mu\text{m}$  with a length to diameter ratio in the range 10 –1000 can easily be selected. The mean distance separating the nanomaterials is also essential; so pore densities in track-etch templates can be scanned from  $10^5$  to  $10^{10} \text{ cm}^{-2}$ , corresponding respectively to a mean separation distance from several tens of  $\mu\text{m}$  to 10 nm. Moreover, the orientation of the pores and thus of the nanowires in relation to the polymer layer surface (all perpendicular, all uniformly tilted or randomly tilted) can also be easily monitored [6].

The choice of material and etching conditions influence the transport properties of the obtained membranes. In literature [7] a study of the transport properties of single asymmetric nanopores in PET and polyimide (Kapton), produced by irradiation of the polymer with heavy ions and subsequent etching, is reported. Electrolytic conductivity measurements show that, depending on the pH value of the electrolyte, asymmetric pores in both polymeric materials rectify the ion current. The asymmetric track-etch pore is prepared by a one-sided etching whereby the short and narrow part at the tip of the etch pit determines the electric properties of the whole channel. This etching method is based on the treatment of an ion-irradiated sample with etchant from one side while the opposite surface of the sample is in contact with a stopping medium. The stopping medium neutralizes the etchant as soon as the etchant perforates the sample thus terminating the pore growth. An additional electrical field gives the chance to detect the instant of pore break-through and makes it possible to additionally protect the etched cone tip from the chemical attack after the pore is formed [8].

Track membranes made of PET and polypropylene (PP) films have a number of peculiarities as compared with other ones. They have high mechanical strength at a low thickness, narrow pore size distribution, and low content of extractables. However, TM have some disadvantages such as low chemical resistance in alkaline media (PET TM) and low water flow rate due to the hydrophobic nature of their surface.

The radiation-induced graft polymerization from the liquid phase permits the modification of PET and PP TM [9]. Three methods of grafting were used: a) the direct method in argon atmosphere; b) the pre-irradiation of TM in air followed by grafting in argon atmosphere; c) pre-irradiation in vacuum followed by grafting in vacuum without contacting oxygen. The aim of the work was to investigate some properties of TM modified by grafted poly(methylvinyl pyridine) (PMVP) and poly(N-isopropylacrylamide) (PNIPAAM). It was shown that the modification of TM with hydrophilic polymers results in the growth of the water flow rate and, in the case of the NIPAAM onto PET TM, the permeation of water through the TM was controlled by temperature and the grafted TM exhibited almost the same transition temperature (about  $33^\circ\text{C}$ ) as that of PNIPAAM and in this temperature range the hydrodynamic diameter of pores varied from 0 to  $0.6 \mu\text{m}$ .

## Conclusions

It can be easily predicted that, because of the increasing interest in the study of nanomaterials and in the development of new techniques for their production, the use of radiation in this field will increase, together with the need of new materials for particular applications.

The main property of the ionising radiation, respect to the conventional synthesis procedures, is that the process can be considered 'solvent free', reducing or avoiding the presence of additives, and the radiation induced reactions can be often realized under normal conditions of pressure and temperature.

With the use of the recent investigation techniques, the new materials can be well characterized and the processes induced by the radiation can be well understood on the basis of the knowledge already obtained and with the help of fundamental studies which are going on in the field of radiation chemistry of polymers.

## REFERENCES

- [1] Y. XIE ET AL, *Nanostruct. Mater.*, 11 (1999) 1165–1169
- [2] Y. XIE ET AL, *J. Mater. Chem.*, 9 (1999) 1001–1002
- [3] Y. XIE ET AL, *J. Mater. Chem.*, 10 (2000) 329–332
- [4] Y. XIE ET AL, *Chem. Mater.*, 13 (2001) 1213–1218
- [5] P. APEL, *Radiat. Meas.*, 34 (2001) 559–566
- [6] E. FERAIN, R. LEGRAS, *Nucl. Instr. and Meth. in Phys. Res. B*, 208 (2003) 115–122
- [7] Z. SIWY ET AL., *Nucl. Instr. and Meth. in Phys. Res. B*, 208 (2003) 143–148
- [8] R. SPOHR ET AL., *Nucl. Instr. and Meth. in Phys. Res. B*, 184 (2001) 337–346
- [9] N.I. SHTANKO ET AL., *Nucl. Instr. and Meth. in Phys. Res. B*, 151 (1999) 416–422)

# RADIATION CURING OF COMPOSITES

A.J. BEREJKA

Ionicorp,  
Huntington, New York, USA

**Abstract** Electron beam (EB) curing of fiber reinforced composites has been of interest since the late 1960s. More recent developments in matrix binder resins, inexpensive techniques for forming shaped articles and in accelerator equipment have led to the implementation of this technology in the aerospace industry. The aerospace demands for high strength materials based on carbon fiber have been successfully met with EB cured products. EB curing greatly reduces the time-to-cure and eliminates issues of toxic volatile release when compared with historic thermally cured systems. Led by sustained interests at the Oak Ridge National Laboratory (ORNL) and through the Society for the Advancement of Material and Process Engineering (SAMPE), government, industrial and academic interests have collaborated to further develop this technology. Current focus has been on determining the feasibility of using EB cured composites as structural members in automotive applications.

## Introduction

The use of ionizing radiation to cure fiber reinforced composites had been proposed by Brenner and Oliver in an award winning paper presented to the Society of the Plastics Industry in 1967. This work involved electron beam (EB) curing of fiberglass prepreps. Development of matrix materials was continued by Campbell and others at the Naval Research Laboratory during the 1970s and then pursued by Aerospatiale in the late 1980s, leading to the construction of a 10 MeV EB facility in France used to produce carbon fiber reinforced rocket motor housings [1]. Additional work was carried on by Atomic Energy of Canada Limited and Acision Industries, Incorporated, of Pinawa, Manitoba, Canada, following the disengagement of AECL from the EB business (Table I). Carbon fiber composites made by Acision are being used on the ailerons of commercial Air Canada aircraft and have logged significant in-flight hours (Fig. 1).

TABLE I. EB COMPOSITES DEVELOPMENT TIMELINE

1967	Brenner & Oliver SPI Paper
1975-79	Campbell et al to SAMPE
1989-90	Beziers/Aerospatiale Papers
1991	Aerospatiale 10 MeV Facility
1987-94	Saunders et al AECL Papers
1994	Formation of 1st ORNL CRADA

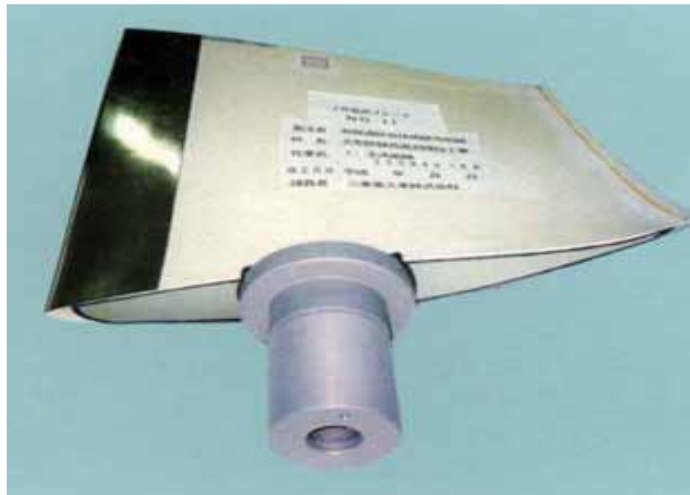

*FIG. 1. EB cured carbon fiber aircraft use.*

### **Recent developments**

The Oak Ridge National Laboratory has led three cooperative research and development programs under US Department of Energy Cooperative Research and Development Agreements (CRADAs) as summarized in Table II. These contributed to the development of EB curable matrix materials comparable in impact resistance and strength to the best of the thermally cured carbon fiber composites that are available for aerospace use. Simplified, low cost fabrication techniques were also developed (Table III, Fig. 2) [2]. A comprehensive report with extensive bibliographic references on this and on previous EB composites work was presented at the twelfth International Meeting on Radiation Processing (IMRP XII) held in Avignon, France in 2001 [3].

The third of these CRADAs focused on the feasibility of using EB cured carbon fiber composites for the manufacture of the hoods and other structural parts of automobiles [5]. A major US auto manufacturer has been impressed with the potential economics and fast production rates attainable with EB curing. Process optimization for fabricating such parts remains to be addressed as well as technical concerns over fiber-matrix interface adhesion. The performance parameters for non-load bearing automotive applications will not be as demanding as for aerospace use and thus open the possibility for using lower cost matrix materials. EB energy requirements will depend upon final automotive part thickness. At present 5 to 7 MeV with high current beams seem to be most suitable for automotive applications. The thickness of the finish part and the choice of fiber reinforcement will dictate the needed EB energy (Fig. 3).



TABLE II. ORNL CRADAs

<p><b><i>CRADA 1 = 1994 to 1997</i></b></p> <ul style="list-style-type: none"> <li>+ Develop more flexible materials</li> <li>+ Study overall economics</li> <li>+ Investigate fabrication alternatives</li> <li>+ Assess tooling options</li> </ul>
<p><b><i>CRADA 2 = 1999 to 2002</i></b></p> <ul style="list-style-type: none"> <li>+ Improve matrix resin toughness</li> <li>+ Address interlaminar shear strength</li> <li>+ Involve carbon fiber manufacturers</li> <li>+ Investigate curing kinetics</li> <li>+ Focus on military — NASA — aerospace             <ul style="list-style-type: none"> <li>Inexpensive prototyping</li> <li>Space structures and repair</li> <li>Aircraft structures andr</li> </ul> </li> </ul>
<p><b><i>CRADA 3 = 1999 to 2002</i></b></p> <ul style="list-style-type: none"> <li>+ Automotive interests</li> <li>+ Specific auto maker involvement</li> <li>+ Feasibility study only</li> <li>+ Economic concerns             <ul style="list-style-type: none"> <li>Cost/amount initiator</li> <li>Cost/Type resin — Epoxy or polyester</li> <li>Fabrication technique</li> <li>Accelerator voltage</li> </ul> </li> </ul>

TABLE III. INEXPENSIVE TOOLING OPTIONS

<p><i>Lost core molding</i></p> <ul style="list-style-type: none"> <li>+ Uses inexpensive wax to form part</li> <li>+ Beam penetrates wax and composite</li> <li>+ Wax melted out after EB curing</li> <li>+ Alternative low cost form materials</li> </ul> <p><i>Missile component molding</i></p> <ul style="list-style-type: none"> <li>+ Uses Epoxy/Foam/Plywood Form</li> <li>+ Tooling weight reduced, &lt;5kg</li> <li>+ Beam penetrates composite and form</li> <li>+ Co-cured multiple matrix resins</li> </ul>
--

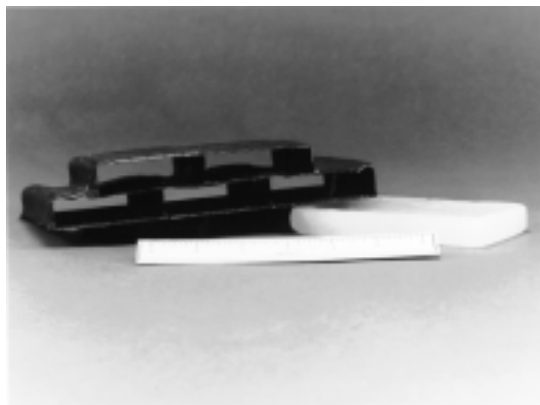

FIG. 2. EB cured honeycomb structure fabricated with 'Lost Core' tooling.

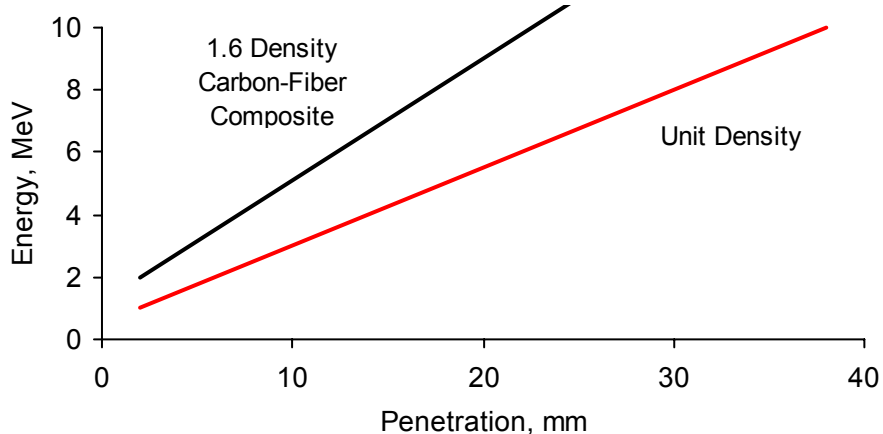

FIG. 3. EB penetration of composite materials.

### Continuing efforts

Some the challenges presented within the context of these CRADAs are being addressed in other forums [4]. The opportunities for using ionizing radiation to cure a diverse array of differently shaped and constructed parts without as much concern for beam-to-part orientation can now be addressed using high current X rays from 5 and 7 MeV electron sources, which are finding use in other application areas [6]. While the Aerospatiale installation in France had some X-ray conversion capabilities for curing the ends of rocket motor housings (Fig. 4), much higher beam currents (20 to 100 mA) are now available with high power X-ray conversion targets. An innovative means of rotating any materials in front of a high current X-ray source has demonstrated uniform penetration of ~1 meter at unit density (~63 cm for carbon fiber composites) material. X-ray processing would enable a manufacturer to use one installation to cure a variety of differently shaped parts without concern for specialized beam presentation. Such processing would still be at rates significantly faster than any thermal cure systems.



FIG. 4. Presentation of a composite structure to an electron beam by Aerospatiale (St. Medard-en-Jalles, France).

The resources available within several academic institutions are engaged in collaborative efforts in the EB curing of composites. These supplement the on-going work being conducted at government laboratories and within the industrial community (Table IV). This will expedite the resolution of some of the issues still under study and facilitate commercial adoption of this process technology.

TABLE IV. ACADEMIC EXPERTISE

<b>Institutions with EB Accelerators:</b>
University of Dayton Research Institute Center for EB Curing of Composites Kent State University NEO Beam 5 MeV High Current EB Facility
<b>Institutions with Composites Expertise:</b>
University of Delaware Michigan State University Texas A&M University Xavier University

## REFERENCES

- [1] BEREJKA, ANTHONY J. The Electron Beam Curing of Composites: The Historical Perspective and Commercial Challenges. To Enercomp 95, Montreal, Canada, (1995).
- [2] NORRIS, ROBERT E.; SCHULZ, M. D. Selection of Materials to be Utilized in Fabrication Tooling for Electron-Beam Curing of Composites. Proceedings of the 28<sup>th</sup> International SAMPE Technical Conference, vol. 28, (1996) 890.
- [3] BEREJKA, ANTHONY J.; EBERLE, CLIFF. Electron Beam Curing of Composites in North America. *Radiation Physics and Chemistry*, 63, nos. 3–6, (2002) 551–556.
- [4] BEREJKA, ANTHONY J. Electron Beam-Cured Composites: Opportunities and Challenges. *RadTech Report*, March/April, (2002) 33–39.

- [5] JOHNSON, MORRIS. EB-Cured Composites for Automotive Applications. *RadTech Report*, November/December (2001) 41–42.
- [6] MEISSNER, JOERN; et. al. X-ray Treatment at 5 MeV and Above. *Radiation Physics and Chemistry*, 57, nos. 3–6, (2000) 647–651.

# ELECTRON BEAM GRAFTING OF POLYMERS

A.J. BEREJKA

Ionicorp,  
Huntington, New York, USA

**Abstract.** Electron beam (EB) grafting has been a well known technique for modifying the surfaces of materials for many years [1]. Commercial implementation has been quite successful in a few, narrow niche markets. Irradiation grafting is being used to control ion flow through battery separator membranes, to modify the hydrophilic and hydrophobic properties of semi-permeable membranes and non-woven fabrics, to enhance the bio-compatibility of materials used in the medical device area, and to impart release properties to films and papers. The use of grafting to modify the bulk properties of materials has not as yet emerged as a widely accepted commercial practice. The development of lower voltage, more cost-effective self-shielded electron beam equipment presents opportunities for enhanced commercial development. The technology used in grafting is very specific to the selection of the base polymer and to the choice of the graft monomers. Different combinations can yield vastly different performance properties.

## Introduction

Grafting adds a monomeric or low molecular weight moiety to a high molecular weight formed polymer, which can be a film, a non-woven, a micro-porous film or a bulk material, to affect various properties. Grafting can be defined as the ability to attach or grow a different material onto the backbone of another. With polymeric materials, the 'different' material is most typically a monomer and the 'backbone' a polymer or other solid. A chemical bond is then formed between the grafted moiety and the material.

Some commonly used graft monomers are acrylates, such as methacrylic acid (to enhance adhesion), acrylic esters and hydroxy functional acrylates (that can couple with polar materials, as wood). Maleic anhydride and n-vinyl pyrrolidone are also used, but with care taken to avoid potential volatilization during processing. The former is used as an adhesion promoter, the latter to enhance bio-compatibility. Specific properties depend both on the backbone or base material that is being grafted and on the graft monomer (Fig. 1).

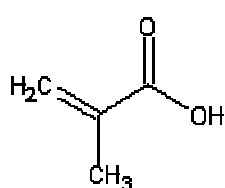

Methacrylic Acid

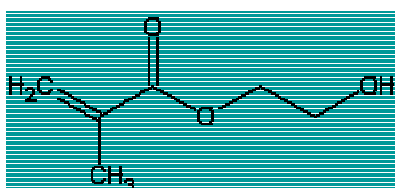

Hydroxy Ethyl Methacrylate

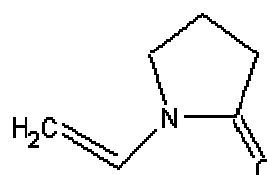

N-vinyl Pyrrolidinone

*FIG. 1. Common graft monomers.*

Vinyl silanes are another class of graft monomers. These materials or oligomers made from them are used as release agents which prevent adhesive materials from sticking to a film or substrate (Fig. 2). Grafted silanes have also found use in bio-medical applications and in the modification of fine inorganic particulates, such as silicas.

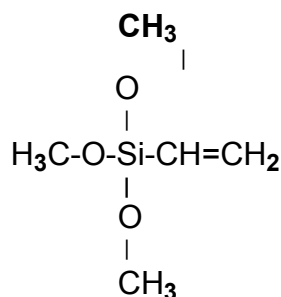

FIG. 2. Vinyl-trimethoxysilane.

### Grafting bulk materials

When used for the modification of bulk materials, such as synthetic polymers, the graft monomer is first blended into the polymer while the polymer is in the melt. This can be achieved in a high shear internal mixer or more commonly in a mixing extruder. The use of a Cavity Transfer Mixer (CTM) facilitates the incorporation of monomers (which tend to be volatile at elevated temperatures) into a polymer melt. While such techniques have been commercially practiced using thermal-chemical systems, electron beam irradiation can be used to eliminate concerns over the sensitivity of reaction catalysts to temperature [2]. The EB processing of bulk plastics in a continuous operation could easily be modified to implement the grafting of polymers like polypropylene for large scale commercial use [3]. The process would be to blend a monomer of choice into a molten plastic using the CTM, pelletize the plastic and then expose the plastic/monomer blend to irradiation from an EB source. Grafted polypropylene as well as grafted polyethylene have been found to have enhanced adhesion to various substrates, such as metals and even glass fibers, when grafted with acrylic acid (AA) or methacrylic acid (MAA), see Fig. 3 .



P HOMOPOLYMER  
not adhered to fiber



ACRYLIC ACID GRAFTED PP  
adhered to glass fiber

FIG. 3. Photomicrographs (2000x) adhesion of PP to 13 micron glass fiber.

The hydroxyl functionality of some acrylate monomers enables said monomers to penetrate into the cell structure of cellulose such as wood and graft onto the wood itself. Subsequent in-situ polymerization of these vinyl monomers have yielded impregnated wood materials with enhanced dimensional stability under cyclic humidity testing and increased wood-polymer toughness [4]. Grafting has also been used in the development of heterogeneous polymer-natural product composites to enhance and maintain the compatibility between the blended materials. Such materials are being examined as a way to incorporate more recycled materials into automotive and truck construction [5].

Similarly, it has been long known that silanol functionality of organo-silanes can couple with the surfaces of fine particulates, such as silicas, enabling the vinyl functionality of such materials to incorporate into EB crosslinked polymers to enhance their toughness [6]. Acrylates too can be used for such inorganic filler enhancement [7]. The reemergence of this technology is gaining fashion as ‘nano-particulate technology.’

### **Grafting films, membranes and non-wovens**

Polyolefin films have been post-irradiation grafted with materials such as trifluorostyrene or methacrylic acid followed by sulfonation to control ion flow through nickel-cadmium batteries [8, 9]. Investigation is underway to use crosslinked films grafted with selected monomers to develop lower cost membranes for fuel cells. A major commercial use of EB grafting has been to modify the surfaces of plastic films and paper with low molecular weight silicones to impart adhesive or release properties.

Monomers, such as n-vinyl pyrrolidinone and hydroxy ethyl methacrylate, have been used to enhance the biocompatibility of films and to control the air permeation and hydrophilicity of microporous films and of non-woven polyolefin materials [10]. Significant opportunities exist to pursue other uses in the bio-materials area [11, 12]. Attempts to produce grafted films to control gas permeation for use in food packaging applications have not met with success [13]. Co-extruded films have proven to be more acceptable in this food packaging area. The modification of films and non-woven materials rely upon low-voltage, self-shielded electron beams. The development of lower cost, low-voltage EB equipment reduces the economic barriers to further development in this area (Fig. 4) [14, 15].



*FIG. 4. Modular EB pilot line for film grafting.*

Table I summarizes, in a very simplistic way, the uses of different types of monomers for different graft applications. Obviously, a more diverse selection of monomers and a large number of substrates can be considered for various well defined product needs. EB grafting is but a tool to meet a large plurality of product opportunities.

TABLE I. GRAFT MONOMER USES

Purposes	Monomer				
	MAA	HEMA	NVP	MA	Si
Adhesion	X			X	X
Toughness	X			X	X
Permeation	X	X	X	X	X
Biocompatibility		X	X		

### Uses, developments and opportunities for grafting

The EB grafting of materials offers numerous opportunities. A few product areas have found a great deal of commercial success. Many other uses of grafting are in various stages of product and commercial development. Table II summarizes the status of some of these uses and opportunities.

TABLE II. EB GRAFTING OF POLYMERS

<p><b><i>Accepted commercial use:</i></b>            1 – Battery separator membranes            2 – Micro-porous membranes and non-wovens            3– Release coated films and papers</p>
<p><b><i>Developed uses in early stages of commercialization:</i></b>            1 – Absorbents for metal ions            2 – Odor absorbent fabrics            3 – Substrates for cell tissue growth            4 – Surface modification of glass windows for ease of cleaning</p>
<p><b><i>Developmental uses:</i></b>            1 – Compatibilization in heterogeneous composites            2 – Fluoropolymer membranes for fuel cells</p>
<p><b><i>Long range opportunities:</i></b>            1 – Select grafted films for biomedical use as transdermal systems            2 – Modification of fabrics for flame retardancy</p>
<p><b><i>Known uses not commercialized:</i></b>            1 – Bulk polymer modification to enhance adhesion            2 – Ion exchange membranes            3 – Controlled gas permeation of food packaging films</p>



## REFERENCES

- [1] CHAPIRO, ADOLPHE. Radiation Chemistry of Polymeric Systems. Interscience, Publishers. John Wiley & Sons, New York (1962).
- [2] BARTZ, KENNETH W.; HIGGINS, JOHN J.; BEREJKA, ANTHONY J.; DICRESCE, AMERIGO J. Thermoplastic Adhesive Compositions. US Patent 3,868,433 (1975) and US Patent 3,987,122 (1976).
- [3] SCHEVE, B. JOSEPH; MAYFIELD, JOHN W.; DENICOLA, ANTHONY J. High Melt Strength, Propylene Polymer, Process for Making it, and Use Thereof. US Patent 4,916,198 (1990).
- [4] LARSEN, L. SCOTT; PAPPANO, ANTHONY. Feasibility Study: Radiofrequency (RF) Curing of Wood Impregnants. Report to the New York State Energy Research and Development Authority, Contract: Modification No. 1 of 4727-IABR-IA-98 (2001).
- [5] CZVIKOVSKY, TIBOR. Radiation Processing of Wood Plastic Composites. Radiation Processing of Polymers. Hanser Publishers, New York (1992) 121–148.
- [6] PLUEDDEMANN, EDWIN. Cationic Silane Coupling Agents for Thermoplastics. *Polymer-Plastic Technology and Engineering*, 2(1) (1973) 89–106.
- [7] KAAS, ROGER L. AND GARDLUND, ZACK G. Surface Modification of Fillers by Radiation Polymerization. General Motors Research Laboratory Publication GMR-2304 (1976).
- [8] D'AGOSTINO, VINCENT F.; LEE, JOSEPH Y.; COOK, JR., EDWARD H. Trifluorostyrene Sulfonic Acid Membranes. US Patent 4,012,303 (1977).
- [9] D'AGOSTINO, VINCENT F.; LEE, JOSEPH Y.; SENTISI, JOSEPH. Separator Membranes for Electrochemical Cells. US Patent 4,230,549 (1980).
- [10] DEGEN, PETER J.; LEE, JOSEPH. Positively Charged Polyvinylidene Fluoride Membrane. US Patent 5,282,971 (1994).
- [11] HOFFMAN, ALLAN S. The use of Radiation Polymerization and Grafting for Biomedical Applications. *Radiation Physics and Chemistry*, 39, (1992) 485.
- [12] ROSIAK, JANUSZ M. Radiation Formation of Hydrogels for Biomedical Applications. International Atomic Agency Report (2002).
- [13] NABLO, SAM V.; RANGWALLA, IM J.; WYMAN, JOHN E. Electron-Initiated Graft Modification of Polyolefins. Radiation Curing of Polymeric Materials, ACS Symposium Series 417, American Chemical Society, Washington, DC (1990) 534-551.
- [14] BEREJKA, ANTHONY J.; FELIS, TIFFANY; FELIS, KENNETH; AVNERY, TOVI. Innovative Electron Beam Emitters. RadTech 2002 Technical Conference Proceedings. (2002) 919–930.
- [15] FELIS, KENNETH; AVNERY, TOVI; BEREJKA, ANTHONY J. Innovative Energy Efficient Low Voltage Electron Beam Emitters. *Radiation Physics and Chemistry*, 63, Nos. 3–6, (2002) 605–608.



# DEGRADATION EFFECTS IN POLYMERS

T. CZVIKOVSKY

Department of Polymer Engineering, Budapest University of Technology and Economics,  
Budapest, Hungary

**Abstract.** The extremely long molecular chains of polymers can be broken easily by the absorption of a quantum of energy above the energy of the covalent bond of the main carbon chain, which typically is in the range of 5 – 10 eV. The energy of beta and gamma photons of 1 to 10 MeV surpasses by many orders of magnitude this minimum value, representing a high risk of degradation to all kind of polymers, naturals and synthetics alike.

The protection of polymers against high doses (20 – 1000 kGy) requires efficient additives preventing and/or stopping chain reaction type oxidative degradation. Primary and secondary antioxidants work well here in synergy. Commercial raw materials are available for radiation-sterilizable medical devices made out of polyolefins and other thermoplastics. Similarly, polymer compounds of suitable formulae are offered commercially for high-dose applications of polymers in nuclear installations.

The controlled degradation of polymers of large molecular mass – or even of cross-linked molecular structures – is a promising field of radiation application.

One area here is related to recycling non-accessible polymers such as fluorinated plastics of cross-linked rubber products. Another large possible area is the controlled radiation degradation of natural polymer systems. Radiation may facilitate the access to cross-linked natural polymer systems, such as wood, plant cellulose and biomass in general, decreasing to use of aggressive chemicals. The result is energetically favorable, environmentally friendly new procedures and raw materials of natural origin.

A limited dose applied to polymers – although may cause some degradation – however may initiate new bonds on the “wounded” chain. The popular graft-copolymerization technique can be applied in new, up-coming polymer processing technologies such as alloying, composite processing and reconstitutive recycling. By this way, even those polymers described earlier as radiation-degrading types, can be cross-linked by radiation in the presence of reactive additives

## Introduction

Polymers, as giant organic molecules with their sophisticated structure represent one of the most organized type of materials, leading up to the functions of life. No wonder if these macromolecules are sensitive against excessive energy transfer. The extremely long molecular chains can be broken easily receiving a quantum of energy above a certain level, causing degradation in structure and properties. The minimum energy required to open the covalent bond of the main carbon chain is in the range of 5 – 10 eV. Consequently the energy of beta and gamma photons of 1 to 10 MeV surpasses by many orders of magnitude this minimum value, representing a high risk of degradation to all kind of polymers, naturals and synthetics alike. In spite of the big difference in energetic level, the degradation caused by ionizing radiation, or UV light, and other lower energies of radiation – is not differing in basic principles.

The degradation effects of ionizing radiation on polymers can be classified from the point of view of the targeted practical applications:

1. – Degradation against which the polymer product should be protected.
  - Assuring radiation tolerance of radiation sterilized polymer devices,
  - Providing stability for polymers in nuclear installations,

2. – Degradation targeting a controlled way of significant decrease in molecular mass
  - Diminishing mol. mass of natural polymers, e.g. cellulose, natural rubber, chitosan, etc.
  - Reuse of (cross-linked) polymers after degradative recycling,
3. – Limited degradation of polymers for creating active, initiation centers for further modification and/or compatibilization, such as
  - Cross-linking,
  - Grafting,
  - Composite processing,
  - Alloying,
  - Reconstituting – recycling: ‘up-cycling’.

Behind all those degradation effects there are very complex phenomena described in detail in the last four decades [1–4].

Considering the sequences of physical and chemical events, at the beginning an extremely rapid energy deposition occurs in the first  $10 \times 10^{-18}$  to  $10 \times 10^{-12}$  s time interval. The chemical processes follow in the next milliseconds ( $10 \times 10^{-3}$  to 1 s). Some „transitional” degradation products however are much more stable in polymers. The frozen-in free radicals are long living enough ( $10 \times 10^3$  to  $10 \times 10^9$  s, or more: up to years!) to use them for later practical applications [5, 6].

### **Protecting Polymers against Undesired Radiation — Degradation**

There are broad industrial application fields of plastics where radiation protection of the polymer is a basic requirement. The radiation-sterilization of single-use, disposable medical devices, applies typically a gamma or EB dose of 25 kGy. This dose is high enough to produce substantial damages in the unprotected polyolefins, used as e.g. PP syringes. The task here is not only to protect the given thermoplastics during the radiation, but also to assure a relatively long storability, 3-5 years of shelf life for the sterilized disposable product without any significant degradation [7].

Even more difficult task is to protect the polymeric structural materials in nuclear installations, such as electrical cables or decontaminable flooring in a nuclear power station or industrial gamma irradiator. The required dose-tolerance here can be as high as 1 MGy and a risk-increasing factor is here the low dose rate, sensitizing even the cross-linked polymers against radiation degradation. The warranted life time span here is typically 30 years, and safety aspects are extremely important.

The protection of the polymers against low doses occurring in the food irradiation may seem as a simpler task. The packaging films of irradiated food should tolerate much less dose, in the range of 1 kGy or less, but the extract-free stability of those materials in food-contact is even more important than the possible mechanical consequences of radiation degradation.

The practical solution of these protection tasks are connected to specific chemical agents, well engineered polymer additives, elaborated mainly for the stabilization of general purpose polymers [8]. The radiation stabilizers, called “antirads” represent only a modest, but flourishing fraction of that thermo-oxidative- and UV stabilizers.

The reason behind the parallel technical development of conventional and radiation stabilizers is related to the fact, that the UV degradation and thermo-oxidative degradation as well as radiation degradation of polymers are all similar *chain reactions*. As such, these processes consist of several steps of: chain initiation, chain propagation, chain branching and chain termination. The scheme according to which these reactions proceed on a H containing polymer chain P is seen in Fig.1.

In spite of the differences in fine details the task is similar in all the three main (thermo oxidative- UV- and radiation) degradation processes, namely to control and/or diminish the danger of deterioration of properties either by

- Preventing chain *initiation*, and/or
- Stopping chain propagation.

In controlling the route of those oxidative chain reactions, there are two main types of antioxidant stabilizers:

- *Primary*, or chain-breaking antioxidants interfere with the chain propagation step. That step is the main carrier of the oxidative degradation.
- *Secondary*, or preventive antioxidants destroy hydro-peroxide groups, responsible for chain initiation and chain branching.

#### *Chain initiation*

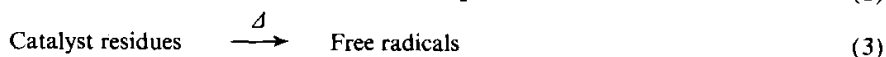
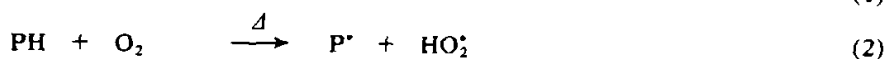
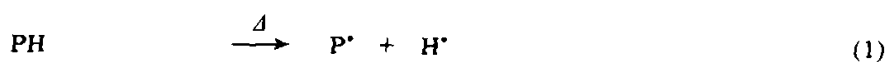

#### *Chain propagation*

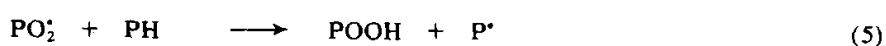

#### *Chain branching*

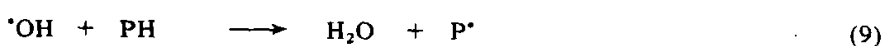
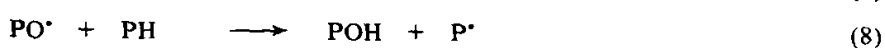
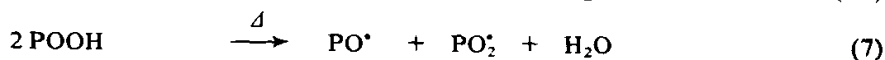
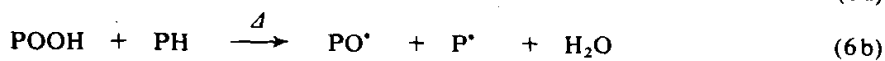
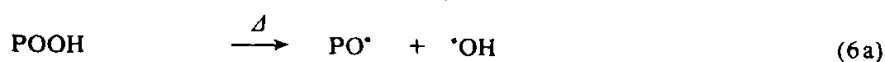

#### *Chain termination*

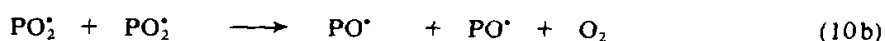
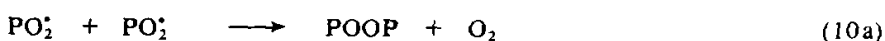

FIG. 1. Scheme of the polymer (thermo-oxidative) degradation as a chain reaction.

The chemical industry of the world is producing in our times yearly more than 200 Mtons of synthetic polymers, is requiring more than 100,000 tons (0.05% of plastics) of antioxidants for the stabilization against degradation. Two thirds of those antioxidants is going to be applied for PE and PP, just requiring the more protection against radiation as well.

Typical primary antioxidants, interfering with the chain-carrying radicals are the ortho-disubstituted phenols, alkylphenols, hydroxyphenyl propionates and hydroxybenzyl compounds, presented on Fig.2. The AO-4 compound, the pentaerythrityl-tetrakis-3,5 di-tert-butyl-4-hydroxyphenyl propionate is one of the most important additive (under a commercial name of *Irganox 1010*,) protecting PE and PP in radiation sterilization. It is important to note, that such stabilizers are never used alone. Secondary antioxidants represent an even greater group of sophisticated organic molecules: aromatic amines, organic sulfur compounds (typically thiobisphenols and thioethers) as well as phosphites and sterically hindered amines. These two latter type of compounds are successfully applied in the radiation-stabilization of PP [7].

It is an important fact, that there is an explicit synergistic effect observed by combining primary and secondary antioxidants. A well known example of such synergistic mixtures is the use of thiodipropionates together with sterically hindered phenols for long-term stabilization of polyolefins. Of course, the different polymers and different applications require laborious optimization of each case.

Clearly, the radiation-protection stabilizer systems should fulfill a whole series of other requirements such as chemical, physical and toxicological safety. Take for example the blood-taking and transfusion sets, made out of plasticized PVC, radiation sterilized and then stored (standing by) for years, later filled with chemically stabilized blood, and cooled and stored again. During all these procedures the protected polymeric material should be stable, should not loose its elasticity, and in the last steps there are strict limitations on traces of all chemicals extractable by the blood.

Fortunately, after long years of research and development works, at the beginning of the 21<sup>st</sup> century the biggest producers of PE, PP, PVC, PA, POM, PC, polysulfons, flouropolymers, thermoplastic elastomers etc. are almost all offering specially stabilized commercial variants of their raw materials stabilized against radiation degradation.

### **Controlled radiation-degradation of polymers**

Another field of application is actually emerging in the polymer engineering, where the radiation-caused degradation is used in a controlled manner to degrade the undesired high molecular mass. This field may be subdivided into:

- Controlled degradation of natural polymers facilitating the next processing step, and
- Reuse of polymers after degradative recycling.

Natural polymers, serving the sustainable development are of increasing importance in the next century. In spite of the extreme rapid development in the synthetic polymers, the yearly yield of the renewable natural polymers, the biomass — is still three order of magnitude higher (hundreds of billion tons/year!) than the production of plastics worldwide (200 Mt/a).

*Alkylphenols*

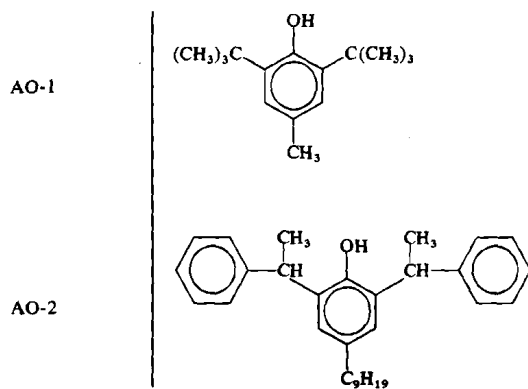

*Hydroxyphenylpropionates*

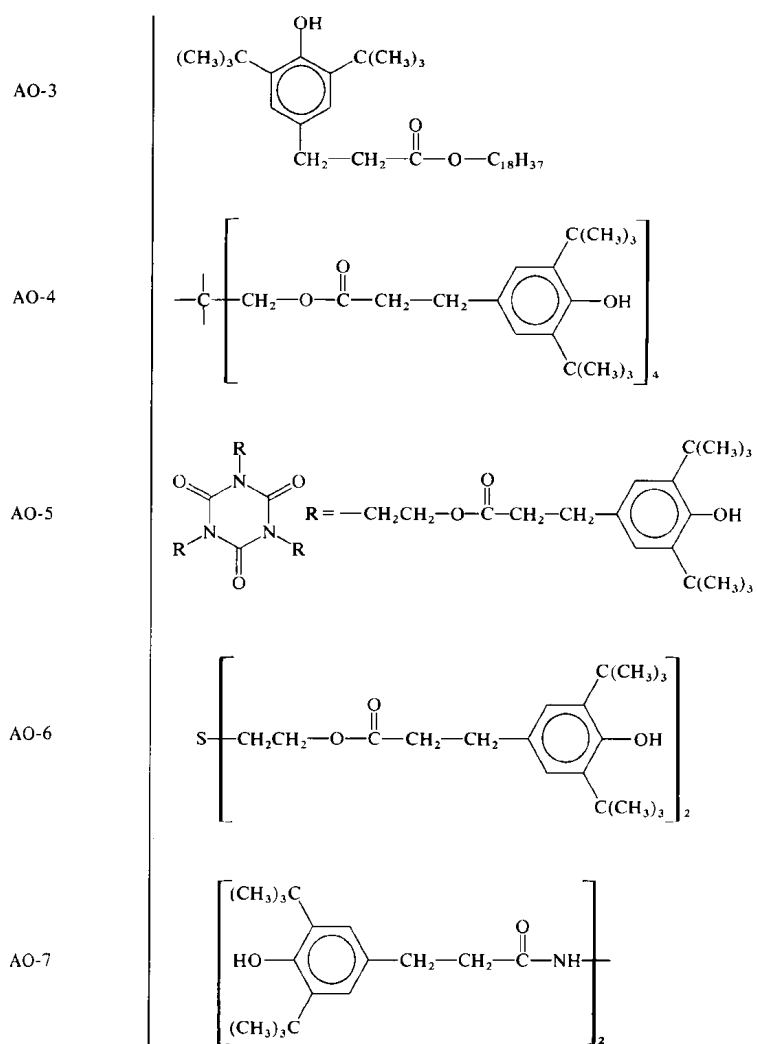

FIG. 2a. Typical primary antioxidants protecting olefin polymers

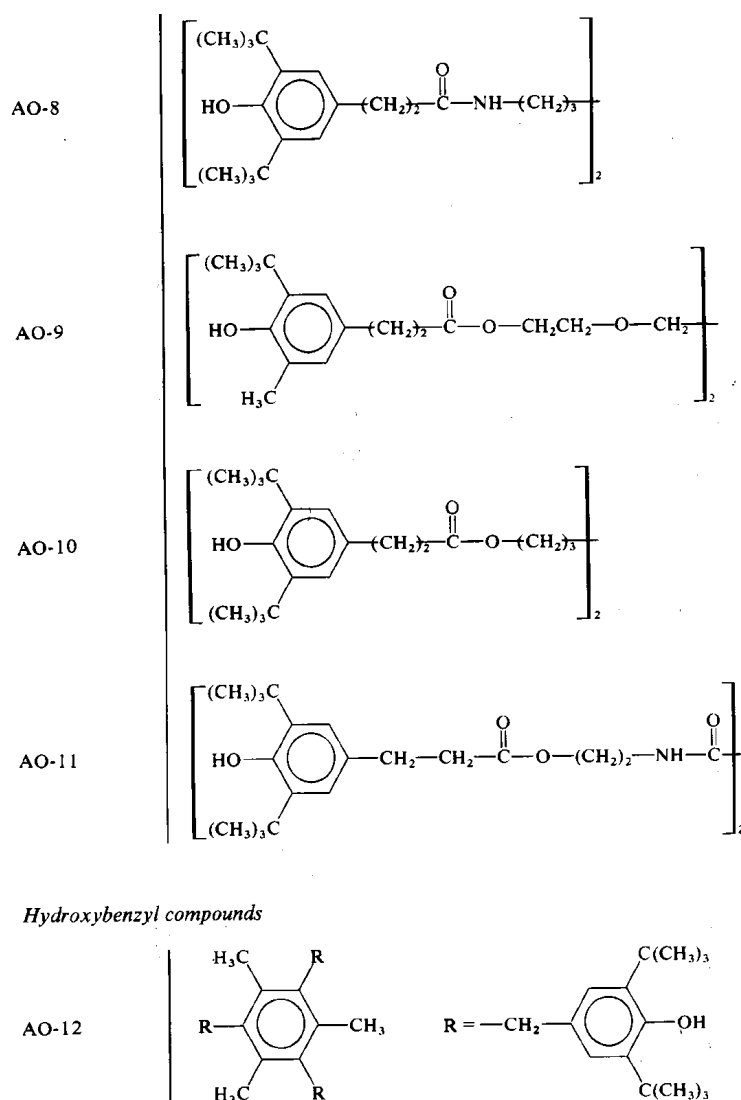
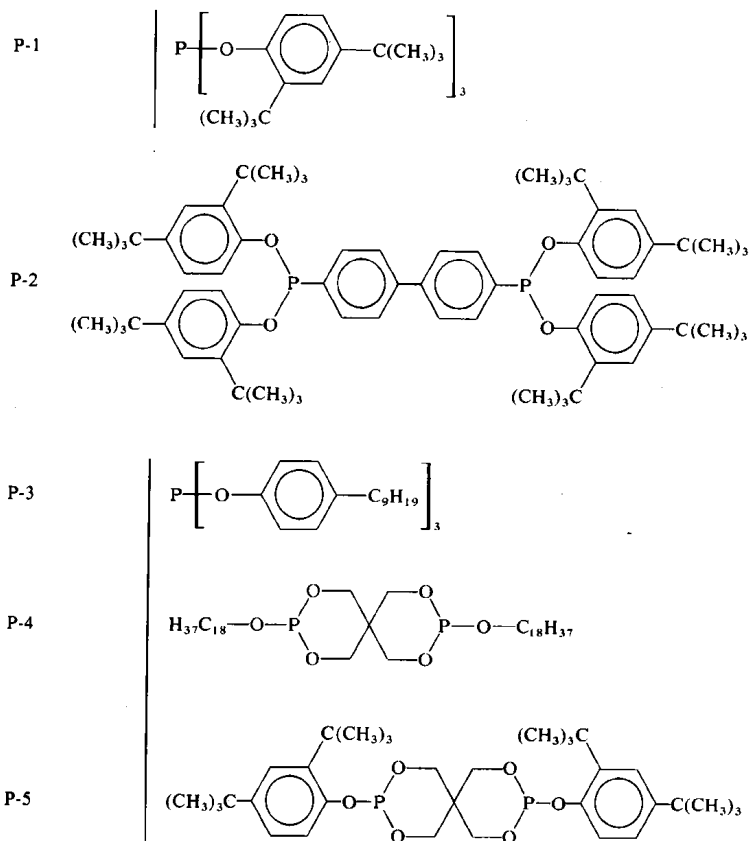

FIG. 2b. Typical primary antioxidants protecting olefin polymers (continuation).

Nature is generous. The molecular mass of most natural polymers is over 1 MDalton, and very often the structure of biopolymers is three-dimensionally cross-linked. The wood, and the similar cellulose-based biopolymers, the most abundant member of the biomass family, is even more complex. In fact, it is a double networked, composite system of cross-linked cellulose reinforcement (fibrous, crystalline, linked through strong H-bonds), embedded in another three-dimensional polymer network if lignin. That is what we call an *interpenetrating polymer network (IPN)* in the polymer material science and engineering. That is contributing to the well known stability against degradation of the wood in the hundred years old houses, in the underwater wooden pylons of Venice (several hundreds of years old), as well as in the thousand years old and still living Sequoias of California. On the other hand this causes the main difficulty in the cellulose and paper production. The IPN is very difficult to open, that is why the pulp and paper industry (bigger than the plastics industry itself) consumes so much aggressive chemicals, resulting in enormous environmental pollution.



*Phosphites and phosphonites*



*Sterically hindered amines*

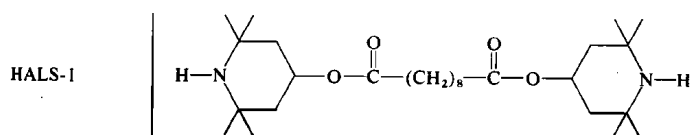

FIG.3. Secondary antioxidants.

Controlled radiation degradation renders the IPN ligno-cellulose composite more easy to open in a subsequent acid hydrolysis in the next processing step, up to form mono- and oligosaccharides [9]. This effect could bring about significant improvements in the cellulose and paper industry [10]. On the other side this radiation degradation could make sawdust or any other agricultural waste of biomass digestible, good enough for animal feed [11]. There is a whole new trend to degrade by radiation different natural polymers, typically byproducts of the food industry, from the empty fruit bunch of the coconut, up to the final waste of the fish processing. The radiation-facilitated accessibility is opening new ways of producing intermediary products for foods, cosmetics or even medicine, see Fig. 4 [9].

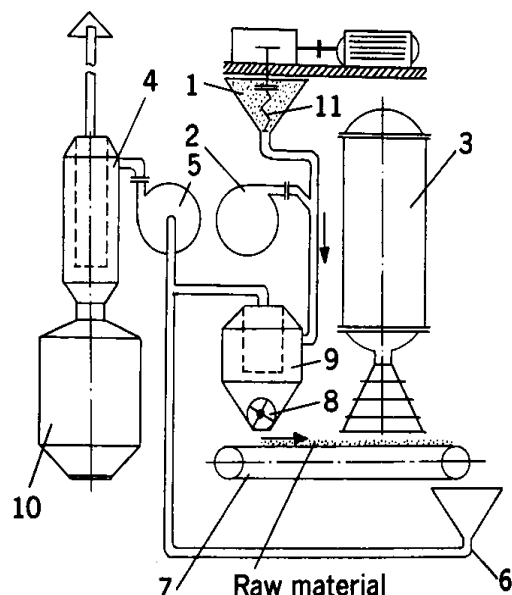

FIG. 4. Irradiation facility to convert cellulose wastes to animal feed [9].  
 1- hopper-meter; 2, 5 - ventilators; 3 - electron accelerator; 4, 9 - cyclones;  
 6 - pneumatic transport; 7 - conveyor; 8 - metering device; 10 - product hopper; 11- screw

Another big field of potential application is the controlled radiation degradation in reprocessing and recycling of polymers. Radiation-induced degradation is applied to convert poly-tetrafluoroethylene (PTFE) scrap into useful, recycled products [9]. Teflon waste is formed during the special processing technologies of this corrosion- and heat resistant polymer. The highly crystalline PTFE cannot be extruded or injection molded as other thermoplastics. High pressure pre-forming is applied on the powder, which is sintered afterwards, similarly to the powder-metallurgy of metals. In the final step of PTFE processing often shaving, milling or drilling is applied, producing a significant amount of scrap. The radiation dose required to degrade such PTFE scraps is relatively high, more than 500 kGy. The G-value of degradation is growing with the increasing temperature:  $G = 0.3, 0.9$  and  $2.1$  scissions/100 eV at 100, 300, and 500 °C, respectively. The perfluorohydrocarbons produced here form a range of chains of 6 to 14 Carbon atoms, and pulverized PTFE as well. The powdered Teflon polymer has additional functional groups that are not present in the original PTFE, e.g. carboxylic acid groups, if irradiation is carried out in the presence of oxygen or air. The PTFE powder is blended with other materials for use as lubricant, other fluorinated products are employed as surfactants.

The degradative radiation-recycling of PTFE led to a successful pilot-scale plant producing 12 tons/year recycled powder at Sumitomo, Japan [9]. For similar polymer-degrading industrial developments several other candidates are very promising. Among other synthetic polymer products, discarded automobile tires represent a major environmental concern, in an amount close to 10 Mtons/a. A promising method is mentioned in the literature [9] in which the vulcanized rubber product is crushed at low temperature, irradiated at a dose rate of 100 kGy, and milled repeatedly, if necessary. The reclaimed “de-crosslinked” material can be added to an extent 10 – 15% to various new rubber blends.

Radiation degradation may help in solving the biodegradability of the plastic wastes as well, but in that field even the first exploratory works are missing, probably because of the involved cost and required time [12, 13].

## Reactive compatibilization through (limited) radiation of polymers

Degradation or build-up (cross-linking) processes as effects of radiation are not excluding each other. Classifying polymers according their behavior under radiation into *degrading* type and *cross-linking* type — may be considered rather an oversimplification today. A limited degradation may be combined with advantageous build-up processes of the polymer structure, such as blending, alloying, grafting, composite processing and new type of composite processing routes, developed from those earlier processes.

Degradation and cross-linking are not exclusive alternatives. This is shown in an extremely interesting recent study of a large Japanese research team in Takasaki [14]. PTFE, known since long as degrading type of polymer under radiation effect, has been cross-linked and grafted at a relatively low dose rate of 3 kGy/h. Radiation cross-linking of PTFE occurs in molten state at 340 °C, just above the melting temperature of Teflon, under Argon pressure of 0.5 Torr, with a dose ranging 60–320 kGy. In a second step of irradiation a graft-copolymerization process may be initiated to modify the reactivity of Teflon by polystyrene side-chains. The copolymer membranes have been chloro-sulfonated thereafter, to make proton-exchange membranes for fuel cell [14]. The procedure may be considered as a successful realization of an earlier attempt [15].

In fact, the numerous literature sources (a full library! see e.g. Refs 2, 9) on radiation grafting is related to the question of limited radiation degradation, followed by a reconstitutive polymerization. A separate lecture is devoted also here, at the present Consultants Meeting to that specific question [16].

The concept is very clear: it may be justified to make moderate radiation degradation onto the targeted polymer, if on the resulting initiation site we start a new polymerization by this. Radiation offers a productive way of forming polymer bridges to bond together very different polymeric and non polymeric element of an engineering structure. That is all similar to the original meaning of *grafting* in the gardening (agriculture) or in the medicine (transplantation). We make a *wound* (on the body, on the plant), than we *heal* it by inserting something healthy, proliferating, growing stuff, to achieve a higher, better quality.

A parallel lecture treats all these processes from the point of view of compatibilization [16]. Here we cite some of our earlier results using recycled wood waste, talc and calcium carbonate to bond together all these components by a modest dose of radiation, in presence of a limited amount of reactive additive [17].

TABLE I. EB-PROCESSED MINERAL REINFORCED POLYMER COMPOSITES

<b>Composition (weight part)</b>					
PP homopolymer	100	70	70	70	70
Talc	–	30	30	–	–
Calcium-carbonate	–	–	–	30	30
Reactive additive	–	–	1	–	1
EB dose [kGy]	–	–	8	–	8
<b>Properties</b>					
Tensile strength [MPa]	32.1	32.9	35.3	30.6	36.9
Flexural strength [MPa]	36.8	47.0	53.8	40.4	45.0
Flexural modulus [GPa]	1.20	2.70	2.88	1.95	1.94
Impact strength [J/m]	15.6	19.5	19.3	18.6	23.9
Heat tolerance at 1 GPa [°C]	51	104	105	82	82
MFI 230°C/2.16 kg, g/10 min	19.2	10.2	40.4	18.0	31.5

By evaluating the WF-PP procedure from the point of view of the dose, we have to note, that even a 9 kGy (low) dose is causing a substantial degradation to the unprotected polypropylene. This is reflected in the Melt-Flow Index (MFI), changing from 2.8 to 16.8 g/600s at 230 °C and 2.16 kp load. Consequently, all the improvements in mechanical properties, heat tolerance and flow capability as benefits of the procedure should be evaluated in view of the degradation-causing initiation. This process begins with a slight degradation, followed by a strong improvement [18].

The radiation initiated compatibilization makes in principle all synthetic and natural polymers radiation cross-linkable, including those considered radiation-degradable in earlier studies.

## Conclusions

- (1) The protection of polymers against high doses (20 – 1000 kGy) requires efficient additives preventing and/or stopping *chain reaction* type oxidative degradation. Primary and secondary antioxidants work well here in synergy. Commercial raw materials are available for radiation-sterilizable medical devices made of polyolefins and other thermoplastics. Similarly, polymer compounds of suitable formulae are offered commercially for high-dose applications in nuclear installations.
- (2) The controlled degradation of polymers of large molecular mass - or even of cross-linked molecular structures – is a promising field of radiation application. One area here is related to recycling non-accessible polymers as fluorinated plastics or cross-linked rubber products. Another large possible area is the controlled radiation degradation of natural polymer systems. Radiation may facilitate the access to cross-linked natural polymer systems, such as wood, plant cellulose and biomass in general, decreasing to use of aggressive chemicals. The result is energetically favorable, environmentally friendly new possible procedures and raw materials of natural origin.

- (3) A limited dose applied to polymers although may cause some degradation, however afterwards, may initiate new bonds on the “wounded” chain. The popular graft-copolymerization technique can be applied in new, up-coming polymer processing technologies such as alloying, composite processing and reconstitutive recycling. By this way, even those polymers described earlier as radiation-degrading types, can be cross-linked by radiation in presence of reactive additives.

## REFERENCES

- [1] CHARLESBY A., Atomic radiation and polymers, Pergamon Press, Oxford, 1960.
- [2] CHAPIRO A., Radiation chemistry of polymeric systems, J.Wiley, NewYork, 1962.
- [3] SCHNABEL W., Polymer degradation, principles and practical applications, Hanser–Macmillen, München, NewYork, 1981.
- [4] CLOUGH R.L., Radiation resistant polymers, In: Encyclopedia of Polymer Science and Engineering, J.Wiley, NewYork, 1988.
- [5] CZVIKOVSKY T., MARX R., Application de la RPE a l’étude du greffage radiochimique du styrene sur les polyolefines, Journal de Chimie Physique (Paris), **68/11**, 1660-1669, 1971.
- [6] CZVIKOVSKY T., Radiation processing of wood-plastic composites, in: Radiation Processing of Polymers, (eds: A. SINGH, J. SILVERMAN), Hanser – Oxford Univ.Press, München, NewYork, 1992.
- [7] LIU D., CZVIKOVSKY T. ET AL., The effect of impact modifier and of nucleating agent on the radiation tolerance of polypropylene, Radiat. Phys. Chem., **35/1-3**, 199-203, 1990.
- [8] GAECHTER R., MÜLLER H., Plastics additives handbook, Hanser – Oxford Univ. Press, München – NewYork, 1990.
- [9] WOODS R.J., PIKAEV A.K., Applied radiation chemistry – Radiation processing, J.Wiley, NewYork, 1994.
- [10] CHUAQUI C.A., MERRITT J. ET AL., EB treatment of wood components, TAPPI Conf., Orlando, Florida, Nov. 3–6, 1991.
- [11] LUNKWITZ K., BRINK H.J., Radiat. Phys. Chem., **33**, 523, 1989.
- [12] CZVIKOVSKY T., Recycling and treatment of plastics waste, In: Radiation technology for conservation of the environment, IAEA-TECDOC-1023, IAEA, Vienna, 1998.
- [13] INTERNATIONAL ATOMIC ENERGY AGENCY Consultants Meeting: Radiation in degrading natural and synthetic polymers, Rio de Janeiro, Brazil, 7–9 August, 2002.
- [14] YAMAKI T., ASANO M., ET AL., Radiation grafting of styrene into crosslinked PTFE films for fuel cell applications, Rad. Phys. Chem., **67**, 403–407, 2003.
- [15] WUCKEL L., CZVIKOVSKY T., ET AL., Herstellung von Ionenaustauscher-membranen mit Elektronenstrahlung, Monatsberichte der DAW zu Berlin, **6/4**, 484–486, 1964.

- [16] CZVIKOVSKY T., Radiation-assisted compatibilization of polymers, IAEA Consultants Meeting: Advances in radiation chemistry of polymers, Univ. Notre Dame, Indiana, USA, 13–17 Sept. 2003.
- [17] CZVIKOVSKY T., Reactive recycling of multiphase polymer systems through EB, Nuclear Instr. and Methods **B 105**, 233–237, 1995.
- [18] CZVIKOVSKY T., EB processing of wood-fiber reinforced polypropylene, Rad. Phys. Chem., **47/3**, 425–430, 1996.

# THE USE OF ELECTRON BEAM FOR PRODUCTION OF TOUGH MATERIALS: THE ITALIAN EXPERIENCE

M. LAVALLE

Institute for the Organic Synthesis and Photoreactivity (ISOF)  
of the National Research Council (CNR),  
Bologna, Italy

**Abstract** The Institute for the Organic Synthesis and Photoreactivity (Bologna, Italy) of the National Research Council is involved in activities carried out together with other scientific institutions (Department of Chemical Engineering, Processing and Materials of the University of Palermo) and an aerospace and defense company (Proel Tecnologie, Firenze, Italy). The research activity is related to:

- study of the electron beam curing process of resins in order to better understand the curing mechanism and the influences of the processing parameters, e.g. the electron pulse frequency, which is related to the delivered dose rate; and
- study of the electron beam polymerization of MMA in the presence of rubber as an alternative and innovative way to produce tough materials as compared to conventional blending (both physical and chemical).

The activity carried out with private companies is related to the irradiation of single items and prototypes to be used for mechanical testing and characterization or for particular applications.

## Introduction

At the Institute for the Organic Synthesis and Photoreactivity (ISOF) is operating a 12 MeV (maximum energy with no load) Vickers L-band (1.3 GHz) traveling wave electron linear accelerator. The LINAC was put in operation mainly to be used as energy source for pulse radiolysis studies.

The accelerator is used as radiation source in the development of new dosimetry systems (physical and chemical) and in the characterization of existing dosimeters in different conditions (a water cooled tantalum converter is used for the generation of X-ray and there is the possibility of controlling the temperature of small samples under irradiation). In Table I the technical specifications of the accelerator are reported.

Other applications of the electron beam involve:

- semiconductor modification;
- sterilization of bone tissues for bone-banking purposes;
- radiation curing of polymer and composite materials.

In this report some of the activities, concerning the field of radiation polymerization and carried out together with other scientific institutions and aerospace and defense companies, are presented:

- study of the radiation curing process of epoxy resins, in order to better understand the curing mechanism and the influences of the processing parameters;
- electron beam induced polymerization of MMA-rubber blends;
- electron beam curing for composite production.

TABLE I. LINAC TECHNICAL SPECIFICATIONS

Pulse length:	from 10 ns – up to 5 $\mu$ s
Pulse repetition rate:	from single pulse up to 600 pulse per second (p.p.s.)
Maximum pulse current:	1 A (2 $\mu$ s pulse) up to 10 A (ns pulses)
Most probable beam energy ( $E_p$ ):	from 6 MeV (longer pulses) up to 11.5 MeV (shorter pulses)
Typical conditions used in the radiation processing set-up:	
Pulse length:	2 $\mu$ s
Pulse repetition rate:	50 p.p.s.
Maximum pulse current:	1 A
Most probable beam energy ( $E_p$ ):	8 MeV

### Study of the radiation curing process of epoxy resins using cationic photoinitiators

Ionizing radiation induced polymerization of epoxies occurs via a cationic mechanism even if a true radiation induced cationic reaction is difficult to perform, because of the presence of basic impurities, such as water; then the presence of a strongly acid photo-initiator is needed. Due to the high technological interest, several studies and patents on radiation curing of epoxy/photo initiator systems are reported. Nevertheless up to now less attention has been devoted to a deeper understanding of the curing mechanism and on the influence of the processing parameters, e.g. the e-beam pulse frequency.

The e-beam pulse frequency is related to the energy absorbed by the material per unit of time, i.e. to the irradiation dose rate; therefore it can affect both the cure reaction kinetics and the heat developed during cure.

During irradiation the sample undergoes to heating because of the occurrence of both exothermic curing reactions and absorption of the radiation energy. The sample temperature profile depends on the balance between the heat evolved during irradiation and the heat released by the sample toward the environment. If the process is fast, i.e. at high pulse frequencies, a dramatic temperature increase can occur and the system undergoes simultaneously to radiation and thermal curing.



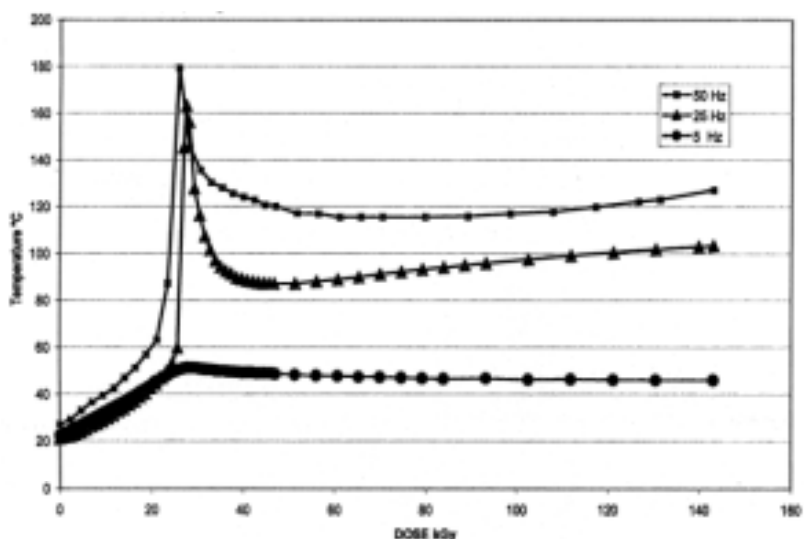

*FIG. 1. Calorimetries collected during the e-beam irradiation of the resin.*

Irradiation conditions: pulse length - 2  $\mu$ s; pulse current - 1 A; dose per pulse - 5 Gy; pulse repetition rate - 5 Hz, 25 Hz and 50 Hz. The resin was placed in a vertical steel mould and a thermoresistor was dipped into the resin and the temperature data acquired during the irradiation.

Measuring the resin temperature permits to monitor the polymerization process because of the exothermicity of the cure reactions. In Fig.1 three calorimetries are shown, collected during the electron-beam polymerization of diglycidyl ether of bisphenol F (Araldite PY306, Cyba Geigy), in the presence of a small amount (3 wt%) of octyl oxyphenyl phenyldiodonium hexafluoroantimoniate (OPPI, General Electric Silicones Company), irradiated using different pulse repetition rates, thus with different dose rates. The sudden rise in temperature indicates the onset of the curing process: the delay can be attributed to the presence of trace amounts of proton acceptors impurities in the resin mixture, such as water, alcohol etc. which interfere with the cationic polymerization mechanism. After the 'induction dose', a fast temperature rise occurs. The values of temperature are always higher for sample irradiated at higher frequency. Significantly different is the temperature profile for sample irradiated at 5 Hz, which shows a very small peak.

For all the irradiation conditions the exothermic effect due to reaction finishes after the absorption of about 40 kGy; after this dose at 50 Hz and 25 Hz the temperature increases up to about 125 and 100°C. At 5 Hz the temperature tends to a plateau value of about 40°C.

Apart for exothermic curing reactions, another thermal effect has to be considered, due to the interaction of ionizing radiation with matter. The temperature profile depends on the balance among (on one hand) the rate of heat production, due both to curing reactions and radiation absorption, and (on the other hand) the heat released, in unit of time, by the system toward the environment. Taking constant the geometry of the reacting system, the heat released toward the environment is constant, while the heat production increases with the pulse frequency.

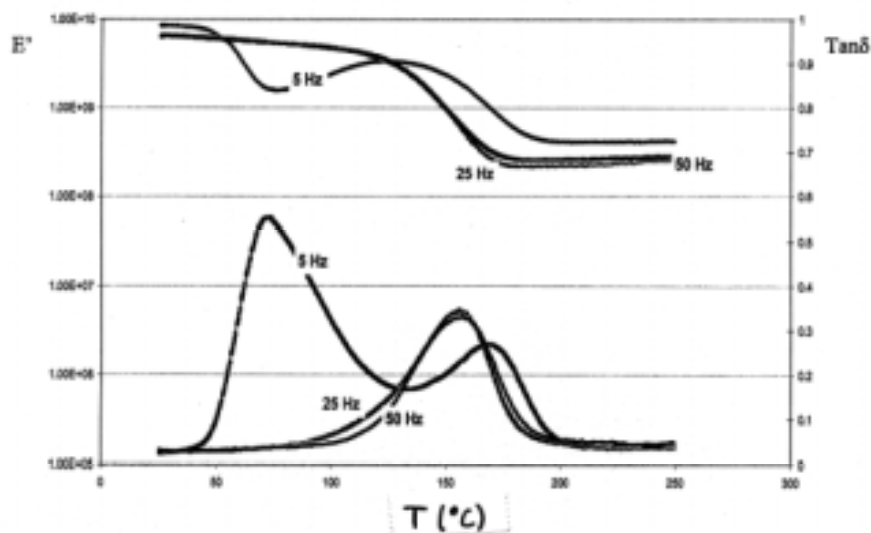

FIG. 2. Storage modulus and  $\tan\delta$  curves for samples cured at 150 kGy at three different frequencies

In Fig. 2 storage modulus and  $\tan\delta$  curves for samples cured at 150 kGy at the three different frequencies are reported. At the lowest frequency (5 Hz)  $\tan\delta/T$  curve shows two distinct peaks, clearly attributable to two different relaxations and an increase of  $E'$  is also observed after the first relaxation.

The behaviour showed in Fig. 2 can be related to the occurrence of a post irradiation thermal cure, during the dynamic-mechanical thermal analysis test, at temperatures higher than the first relaxation. Samples irradiated at higher frequencies show only a relaxation peak at high temperature, thus indicating the occurrence of thermal cure during the irradiation itself.

Solubility tests for samples irradiated at 150 kGy show that the insoluble fractions are about 97% for samples cured at 5 Hz, while completely insoluble materials are obtained at higher frequencies. Furthermore the effect of solvent is markedly different: at 5 Hz the sample loses its integrity, while at higher frequencies integral swelled samples are obtained, thus confirming that in these last conditions (high dose rate) a more cross-linked structure is obtained, as a consequence of both radiation and thermal curing.

### **Electron beam induced polymerization of MMA in the presence of rubber: a novel process to produce tough materials**

The obtainment of tough materials has been the subject of many studies in the past decades. The incorporation of elastomeric particles into the bulk of thermoplastic brittle polymers is a well-known technique used to improve toughness. Blending of elastomeric and thermoplastic components can be performed both through physical and chemical techniques. Physical blending involves mixing of two immiscible polymers using processing equipments such as extruders, rolling mills etc. The final morphologies are determined by the processing conditions and by the intrinsic characteristics (viscosity, compatibility, interfacial tension, etc.) of the involved polymers. Usually, the only way to affect the final morphology is to add a compatibiliser during blending to reduce the size of the dispersed phase. Chemical blending consists in polymerizing at least one of the two components of the final blend in the presence of the other one. At the beginning of the reaction the system is homogeneous but, as

polymerization proceeds, a chemically induced phase separation (CIPS) can occur, affecting the final morphology.

An alternative and innovative way to the conventionally initiated reactions can be the use of ionizing radiation, like gamma photons or accelerated electrons [1]. Some significant advantages can be ascribed to this polymerization route both in terms of purity of the final products and polymerization temperature and initiation rate range of operation.

The blends studied were:

- methyl methacrylate with 100 ppm of hydroquinone, from Merck;
- rubbers used were:
  - ABN rubber (acrylonitrile/butadiene/methacrylic acid, from Ciba Geigy);
  - SBR rubber (a copolymer of styrene/butadiene, from Ciba Geigy);
  - VTBNX (acrylonitrile-butadiene with unsaturated end groups).

Before irradiation MMA was distilled under vacuum to remove inhibitor. After rubber addition (4 wt%), oxygen was removed and the solutions were placed in vials suitable for irradiation. The irradiation was performed at the ISOF LINAC, using 2- $\mu$ s pulses at 10 pulse per second, delivering 7.6 Gy per pulse. For each kind of rubber used, the total absorbed doses started from 120 up to 145 kGy. The irradiation temperature was measured and during the process it raised from 22 °C to about 140 °C.

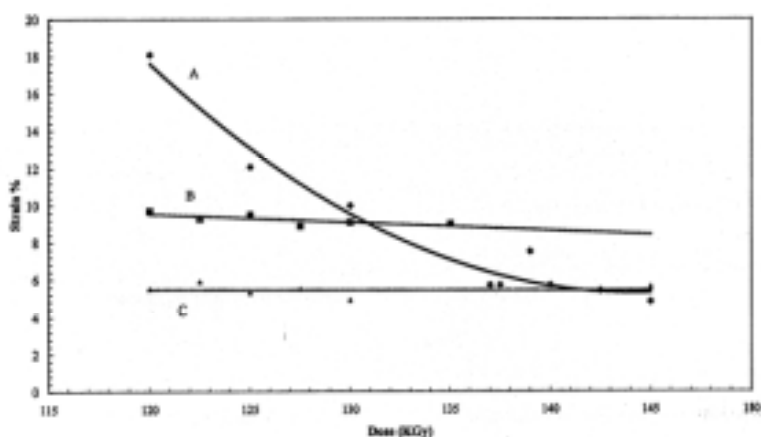

FIG. 3. Percentage of strain at break ( $\epsilon$ ) for various blends  
A) PMMA-ABN; B) PMMA-SBR; C) PMMA-VTBNX.

In Fig. 3 the elongation at break ( $\epsilon$ ) for the irradiated blends are shown. The  $\epsilon$  values of all the systems are higher than the value of pure polymethylmethacrylate (about 4%). The best results are shown by PMMA-ABN system, which has a pronounced increase of ductility in comparison to pure PMMA, with a strain at break that almost reaches 20% for the system irradiated at 120 kGy. Toughening decreases as the dose increases. PMMA-SBR blends also show an increase of the elongation at break, with respect to pure PMMA. Furthermore, no effect on the elongation at break increasing the irradiation dose is observed. PMMA-VTBNX blends do not show significant improvement of ductility, with low  $\epsilon$  values, very similar to pure PMMA.

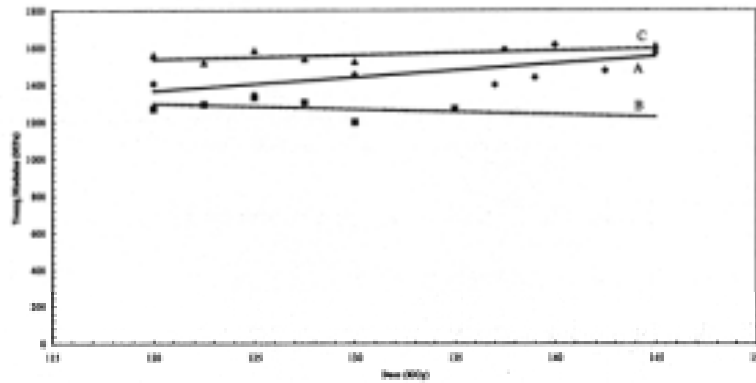

FIG. 4. Young moduli for various blends  
 A) PMMA-ABN; B) PMMA-SBR; C) PMMA-VTBNX

In Fig. 4 the Young moduli of the irradiated blends are reported. All values are slightly lower than the modulus value of PMMA (about 1700 MPa) despite the significant improvement in the toughness. The highest values are for PMMA–VTBNX blends and an increase of modulus for PMMA–ABN occurs with an increase in the absorbed dose, while no significant changes with dose are observed for the other systems.

The most interesting result is that there are no marked changes with respect to the mechanical properties of pure PMMA. The results can be explained considering that during irradiation several processes can occur. They involve monomer polymerization, rubber chain branching and cross-linking (possibly involving PMMA chains) and degradation of PMMA already formed; also interactions among all the blend components are caused. A competition between all these phenomena can be suggested.

PMMA degradation determines a general decrease of mechanical performances of the material; while the other phenomena may have beneficial effects even if rubber cross-linking can produce a decrease in the strain at break. These mechanisms, however they work, determine a decrease in the strain at break and a slight increase of the yield stress upon further irradiation. The different responses of the system varying the rubber nature is clearly attributable to the different effects of ionizing radiation on the rubber, which affect the final structure of PMMA-rubber blend.

### Electron beam curing for composite production

The activities carried out with an Italian R&D space company, Proel Technologie (Florence) led to the realization of thick composite materials for space applications. Proel faced the following tasks:

- to look for commercially available EB curable resins and their characterization after EB irradiation, in order to identify those having features as much as possible close to end-user requirements (aerospace application);
- to make a database including the best polymerization conditions for each resin;
- to develop its own formulation. Both acrylated and epoxy formulation have been developed. In particular, epoxy formulations are EB cured by addition of proper onium salts initiators.

ISOF supported the EB irradiation at the LINAC facility.

The composites obtained were used as reference for the testing of those produced by a Proel patented process (Proel patent n. F191A100, n. 5252265 for USA) of filament-wound curing of resin impregnated fibres [2]. This process permits the realization of composites without limits in the thickness using low energy electrons.

### **Future activities**

The future activities of the Institute for the Organic Synthesis and Photoreactivity, together with the Department of Chemical Engineering, Processing and Materials of the University of Palermo, will be focused in the better characterization of the influences of the processing parameters and additives in the radiation curing of polymers.

Together with private companies, the activity will be mainly related to the realization of prototypes and to the irradiation of samples in order to assist the transfer of the radiation technology from the laboratory conditions to the real industrial production.

### **REFERENCES**

- [1] D. CANGIALOSI ET AL., *Radiat. Phys Chem.*, 63 (2002) 63-68
- [2] F. GUASTI, E. ROSI, *Composites Part A*, 28A (1997) 965-969



# APPLICATION OF HIGH POWER X RAY GENERATORS FOR PROCESSING BULK MATERIALS

M.R. CLELAND

IBA Technology Group,  
Edgewood, New York, USA

**Abstract.** High power, high energy X ray (*bremstrahlung*) generators are suitable sources of ionizing radiation for processing bulk materials. The basic physical, chemical and biological effects of irradiating materials with this form of energy are essentially the same as the effects obtained with gamma rays and accelerated electrons. The choice of energy source for a particular application depends on practical aspects of the irradiation process, such as material thickness, throughput rate, dose uniformity ratio and economics. X ray photons are emitted when energetic electrons strike any material. The intensity increases with the energy of the incident electrons and with the atomic number of the target material. With electron energies greater than 1 MeV, the angular distribution of the emitted radiation is concentrated in the direction of the electron beam. The efficiency for conversion incident electron beam power to useful X ray power in the forward direction is relatively low; typically about 8% at 5.0 MeV, 13% at 7.5 MeV and 16% at 10 MeV. The low converting efficiency can be compensated by using high power electron beams. The broad energy spectrum of *bremstrahlung* (braking radiation) extends up to the maximum energy of the incident electrons. Although the most probable photon energy is only about 0.3 MeV, the penetration is significantly greater than gamma rays from large area cobalt-60 sources. The penetration of high energy X rays allows large loads of high density materials to be irradiated with low dose uniformity ratios. The narrow X ray beam allows pallet-sized loads to be irradiated singly, thus shortening the irradiation time. This facilitates changing the processing conditions for different materials. In contrast to the emission of gamma rays from radioactive sources, X ray generators can be switched off when not needed for production. This saves energy and simplifies maintenance procedures. High power, high energy electron accelerators are now available, with electron beam power ratings of 300 kW and 500 kW at 5 MeV and up to 700 kW at 7 MeV. Several industrial X ray processing facilities have already been built in Japan, North America and Europe. X ray processing is now a practicable and economically competitive technique. X ray processing is a relatively new irradiation method that can be used for various applications, such as sterilizing medical devices, preserving foods, curing composite structures and improving the properties of bulk materials.

## Introduction

High power, high energy X ray (*bremstrahlung*) generators are suitable sources of ionizing radiation for processing bulk materials. The basic physical, chemical and biological effects of irradiating materials with this form of energy are essentially the same as the effects obtained with accelerated electrons and gamma rays. For those applications that are sensitive to the dose rate, X ray dose rates are between the high dose rates of electron beams and the low dose rates of gamma ray sources. The choice of energy source for a particular application is usually based on practical aspects of the irradiation process, such as material thickness and density, throughput rate, dose uniformity and economics.

X ray photons are emitted when energetic electrons strike any material. The intensity increases with the energy of the incident electrons and with the atomic number of the target material. With electron energies greater than 1 MeV, the angular distribution of the emitted radiation is concentrated in the direction of the electron beam. The efficiency for converting incident electron beam power to useful X ray power in the forward direction is relatively low, typically about 8% at 5.0 MeV, 13% at 7.5 MeV and 16% at 10 MeV with appropriate target materials. The low conversion efficiency can be compensated by using high power electron beams to obtain useful throughput rates. The broad energy spectrum of *bremstrahlung* (braking radiation) extends up to the maximum energy of the incident electrons, and the mean

photon energy is comparable to the gamma ray energies from cobalt-60. The penetration in bulk materials is significantly greater than that of gamma rays from large area, un-collimated sources, because of the narrow angular distribution of high energy *bremsstrahlung*.

The penetrating quality of this type of radiation allows large process loads of high density materials to be irradiated with acceptable dose uniformity. The narrow photon beams allow pallet-sized loads to be irradiated singly. This facilitates changing from one processing condition to another for different applications. It also minimizes the irradiation time, which is helpful when irradiating chilled foods. In contrast to the emission of gamma rays from radioactive sources, X-ray generators can be switched off to save energy when not needed for production. This characteristic simplifies shipping, installation and maintenance procedures.

### **Physical properties of high energy X rays**

The energy distributions of photons emitted in the forward direction through the X ray target with incident electron energies of 5.0 MeV, 7.5 MeV and 10 MeV are shown by the curves in Fig. 1 (all figures are placed at the end of the text). These spectra have been calculated with the ITS Monte Carlo code for tantalum targets with optimum thicknesses [1]. The areas under these curves indicate that the emitted X-ray energy increases with the energy of the incident electrons. These curves also show that the maximum photon energy corresponds to the incident electron energy, the mean energy is about 20% of the maximum energy, and the most probable photon energy is about 0.3 MeV in each case.

The angular distributions of the emitted photons are shown by the curves in Fig. 2. The X-ray intensity is greatest at zero degrees, that is, the direction of the incident electrons, and it is also evident that the angular dispersion decreases as the electron energy increases. This implies that a high energy scanning electron beam produces a scanning X-ray beam, which can be concentrated on the process load.

The X-ray depth dose distributions in a thick water absorber with large area beams are shown in Fig. 3. These distributions indicate that the attenuation is essentially exponential, and that the penetrating quality increases with the incident electron energy. Depth dose distributions for irradiating materials from opposite directions show the minimum dose in the middle of the material. The dose uniformity ratio (DUR), also known as the  $D_{\max}/D_{\min}$  dose ratio, increases with the thickness of the material, as shown in Fig. 4 (lower set of curves). For any thickness, the DUR decreases as the incident electron energy increases.

The relationships between the X-ray power utilization efficiencies and the water thickness are also shown in Fig. 4 (upper set of curves). The practical or effective X-ray power utilization efficiency is obtained by multiplying the minimum dose by the mass of the water and dividing by the emitted X-ray power. This calculation does not take into account the higher doses closer to the surfaces of the water. The maximum value of this effective power utilization efficiency occurs at a depth where the decreasing minimum dose offsets the increasing water thickness. At the optimum thickness for maximum X-ray power utilization, the DUR value for large area sources and absorbers is about 1.5 for each incident electron energy, if edge effects are not taken into account.

The information discussed above is summarized in Table I. This includes the X-ray mean energy, the X-ray emission efficiency, the tenth value layer for attenuation in water, the optimum thickness of water for maximum X-ray power utilization efficiency and the DUR at



the optimum thickness for incident electron energies of 10 MeV, 7.5 MeV and 5.0 MeV with tantalum targets [2-5]. Similar data for large area Co-60 gamma ray sources are also included for comparison [6]. These physical properties have been evaluated with the ITS Monte Carlo code or with the earlier versions of that code, ETRAN and ZTRAN [1].

TABLE I. PROPERTIES OF HIGH ENERGY X RAYS OBTAINED FROM ITS MONTE CARLO CALCULATIONS

Electron Energy (MeV)	X-ray Mean Energy (MeV)	X-ray Emission Effic. (%)	Tenth Value Layer (cm)			Optimum Thickness	
			Present Calc.	Work Meas.	Previous Work	Double Sided (g/cm <sup>2</sup> )	DUR
10	1.56	16.2	49.0	47.9	49.0	43	1.54
7.5	1.38	13.3	44.3	N/A	N/A	38	1.54
5.0	1.19	8.2	39.0	39.5	38.0	34	1.54
Co-60	1.25				31.0	28	1.75

### Material processing capabilities

An important advantage of using high energy X rays to process materials is the ability to irradiate large, high density product loads with acceptable dose uniformity. It would be desirable to irradiate typical shipping pallets loaded with packages of bulk materials, such as plastic powders or pellets, or with fresh foods, without unloading the pallets. This would reduce the labor and the risk of damaging packages or products by rough handling.

However, requirements for low DURs impose limits to the size and density of product loads. Theoretical relationships between these quantities when square containers of finite size are irradiated from opposite sides with 5.0 MeV X rays are shown in Fig. 5. The horizontal axes give the container size in cm, and the vertical axis gives the DUR. The four curves are for different densities ranging from 0.2 to 0.8 g/cu cm. If a DUR of 2.0 is acceptable, then the container sizes can be about 180, 100, 70 and 50 cm for densities of 0.2, 0.4, 0.6 and 0.8 g/cu cm, respectively. If a lower DUR of 1.5 is needed, then the container sizes will be limited to about 120, 60, 45 and 30 cm, respectively. These results were calculated with the GEANT3 Monte Carlo code [7, 8].

A better method for irradiating high density pallet loads is the Palletron system, which is illustrated in Figs 6 and 7. The main components of this system are a high energy, high power electron accelerator, an electron beam scanner, a long, narrow X-ray target located on one side of the pallet, a pair of long, thick metal plates to collimate the X-ray beam and a rotating platform to support and turn the pallet while it is being irradiated [9].

The purpose of the collimator plates is to limit the divergence of the X rays. This reduces the maximum dose, which occurs near the outside surface of a rotating, high density pallet load, without reducing the minimum dose, which occurs in the middle of the load. The separation between the collimator plates must be adjusted according to the density of the product load to optimize the dose uniformity. The effects of changing the collimator separation with a high density cylindrical load are shown in Fig. 8. If the separation is too wide, then the outside dose is higher than the middle dose. On the other hand, if the separation

is too narrow, then the outside dose is lower than the middle dose. The optimum separation gives a minimum DUR [10].

Some results of dose calculations with the GEANT3 code for rectangular pallets are presented in Figs 9 through 12 for incident electron energies of 5.0 MeV and 7.5 MeV with 300 kW of electron beam power at each energy and a minimum dose of 2.0 kGy. Calculations were repeated at 2° intervals to simulate continuous rotational irradiation. The pallet dimensions were: width 100 cm, length 120 cm, height 178 cm. The bulk densities of the product material ranged from 0.1 g/cu cm to 0.8 g/cu cm. With densities below 0.4 g/cu cm, the collimators were not needed and the rotation speed was constant. With higher densities, the collimators were beneficial and the rotation speed was varied with the angle of rotation to compensate for the rectangular shape of the pallets [11-13].

The data shown in Fig. 9 indicate that the DUR is less than 1.4 with both energies and for all densities, except for 0.1 g/sq cm with 7.5 MeV. In this case, the greater penetration with the higher energy produced a higher dose in the middle of the pallet than on the outside, and the DUR was about 1.5. With very low densities, this effect could be compensated by inserting a long, narrow metallic absorber between the target and the pallet in the middle of the X ray field.

The data shown in Fig. 10 indicate that the treatment times per pallet with a density of 0.8 g/cu cm would be about 8.5 minutes at 5.0 MeV and 4.8 minutes at 7.5 MeV. The treatment time increases with the product density, because this calculation is based on the minimum dose in the middle of the pallet. With doses higher than 2.0 kGy, which would be required for most polymer modifications, the time would increase in direct proportion to the dose. For example, assuming 300 kW of electron beam power at 7.5 MeV, the treatment time for a 20 kGy dose would be about 48 minutes per pallet with a density of 0.8 g/cu cm. At the other end of the density scale, the treatment time for 20 kGy with densities in the range of 0.1 to 0.3 g/cu cm would be about 22 minutes per pallet.

The data shown in Fig. 11 indicate that the hourly throughput would be about 20 tons per hour with 300 kW of electron beam power at 7.5 MeV, a density of 0.8 g/cu cm and a minimum dose of 2.0 kGy. The data in Fig. 12 show that this would be equivalent to a yearly throughput of about 160,000 tons per year. A lost time of 20 seconds for changing pallets has been added to the treatment time for these throughput calculations. With higher doses, which would be required for most polymer modifications, the throughput would decrease in inverse proportion to the dose. For example, assuming 300 kW of electron beam power at 7.5 MeV, the throughput rate for a 20 kGy minimum dose would be about 2 tons per hour or 16,000 tons per year with a density of 0.8 g/cu cm. At the other end of the density scale, the throughput rate for 20 kGy with a density of 0.2 g/cu cm would be about 1.0 ton per hour or 8000 tons per year. The lower density would allow more X-ray energy to pass through the pallet, which would reduce the X-ray power utilization efficiency. The maximum efficiency would occur with densities in the range of 0.6 to 0.7 g/cu cm.

## **X ray processing facilities and equipment**

Several industrial irradiation facilities can now provide both X-ray and electron beam processing for a variety of applications. There are three such facilities in Japan. One of these is equipped with a 5.0 MeV, 150 kW Cockcroft Walton accelerator [14]. Another one has a 5.0 MeV, 200 kW Dynamitron accelerator [15], and the third facility has a Rhodotron

accelerator with two beam lines rated for 135 kW at 5.0 MeV and 200 kW at 10 MeV [16]. There are two facilities in the United States, which can also provide both X ray and electron beam processing. One of these has an L-band microwave linac rated for 150 kW at 5.0 MeV [17]. The other one has a Rhodotron accelerator with three beam lines rated for 135 kW at 5.0 MeV, 190 kW at 7.0 MeV and 200 kW at 10 MeV [18]. In addition, there is a facility in France, which has an S-band microwave linac rated for 20 kW at 10 MeV [19].

Recent developments have increased the beam power ratings of high energy electron accelerators to provide higher throughput rates for X ray processing. The Dynamitron accelerator, made by RDI in the USA, has been upgraded from 200 to 300 kW at 5.0 MeV [20], and the Rhodotron accelerator, made by IBA in Belgium, has been upgraded from 200 to 500 kW at 5.0 MeV and 700 kW at 7.0 MeV [21]. The emitted X ray power at 5.0 MeV and 500 kW with 8% conversion efficiency would be 40 kW. This would be equivalent to the gamma ray power emitted by about 3 MCi of cobalt-60. The emitted X ray power at 7.0 MeV and 700 kW with 13% conversion efficiency would be 91 kW. This would be equivalent to the gamma ray power emitted by about 6.5 MCi of cobalt-60.

## **Conclusion**

X ray processing is now a practicable and economically competitive technique. X ray processing is a relatively new irradiation method which can be used for various applications where greater penetration would be beneficial, such as sterilizing medical devices, preserving foods, curing composite structures and improving the properties of bulk materials.

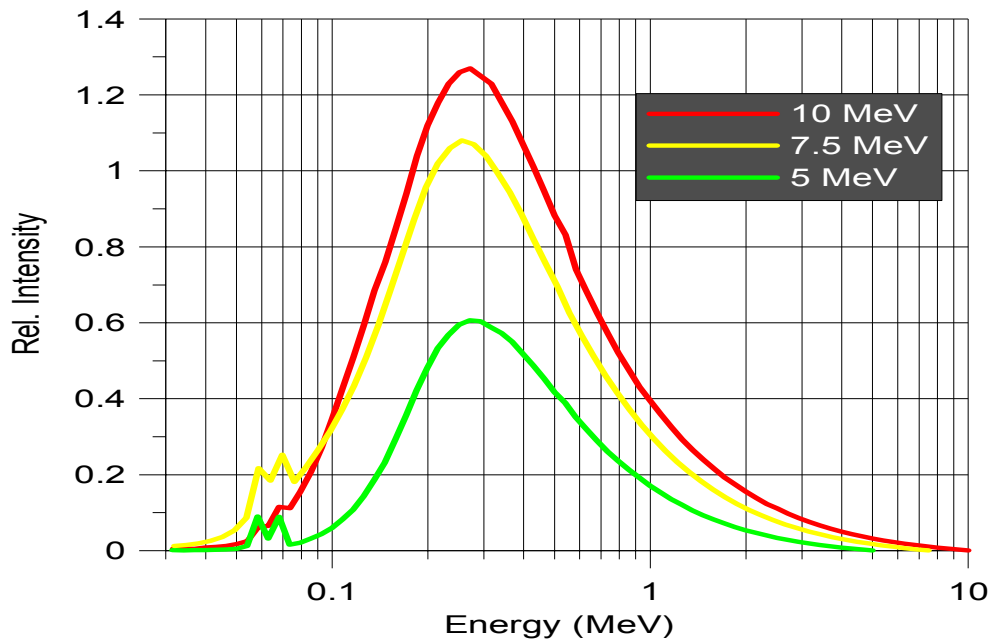

FIG. 1. Bremsstrahlung photon intensity vs photon energy from a tantalum target with incident electron energies of 5.0 MeV, 7.5 MeV and 10 MeV.

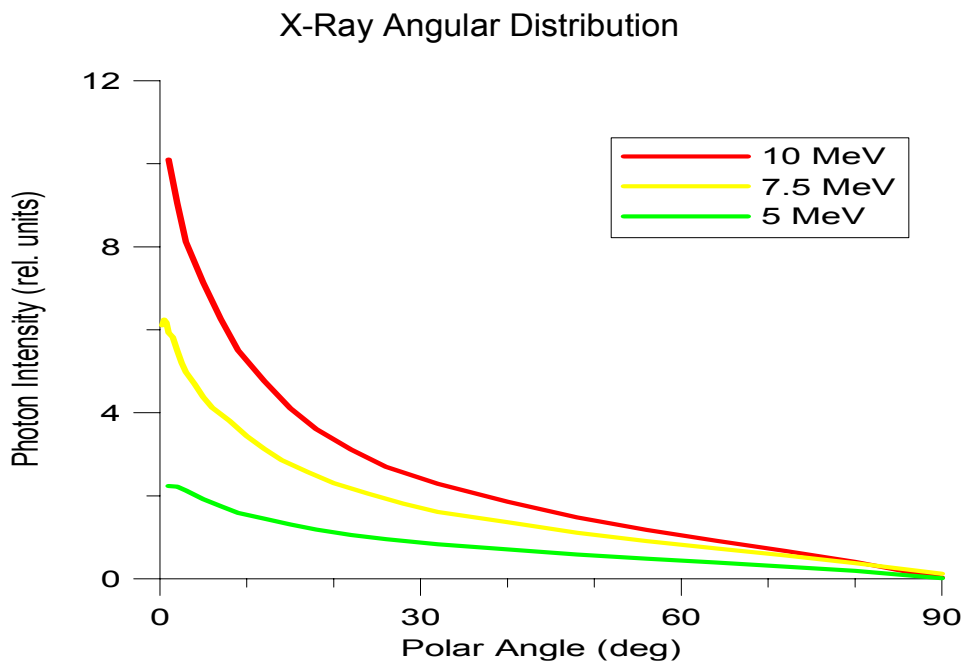

FIG. 2. Bremsstrahlung photon intensity vs emission angle from a tantalum target with incident electron energies of 5.0 MeV, 7.5 MeV and 10 MeV.

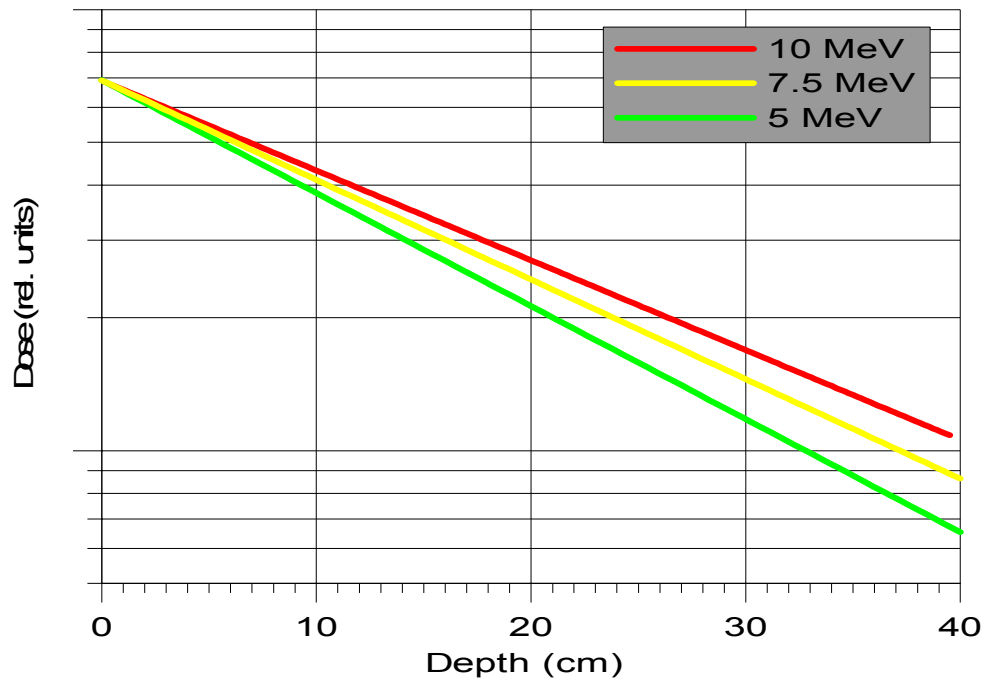

FIG. 3. Relative depth dose curves in water for maximum X ray energies of 5.0 MeV, 7.0 MeV and 10 MeV.

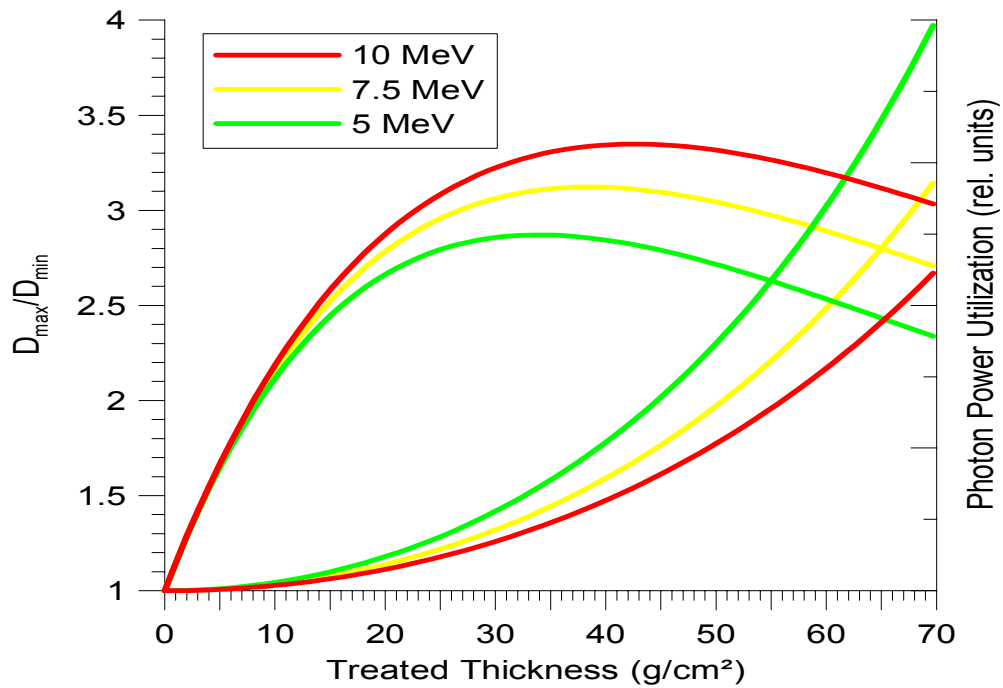

FIG. 4. Dose uniformity ratios ( $D_{max}/D_{min}$ ) and X ray power utilization efficiencies vs water thickness for maximum X ray energies of 5.0 MeV, 7.5 MeV and 10 MeV. The lower doses at the ends of finite pallet loads have not been taken into account in these calculations.

## Dose Uniformity Ratios for Double-Sided Irradiation

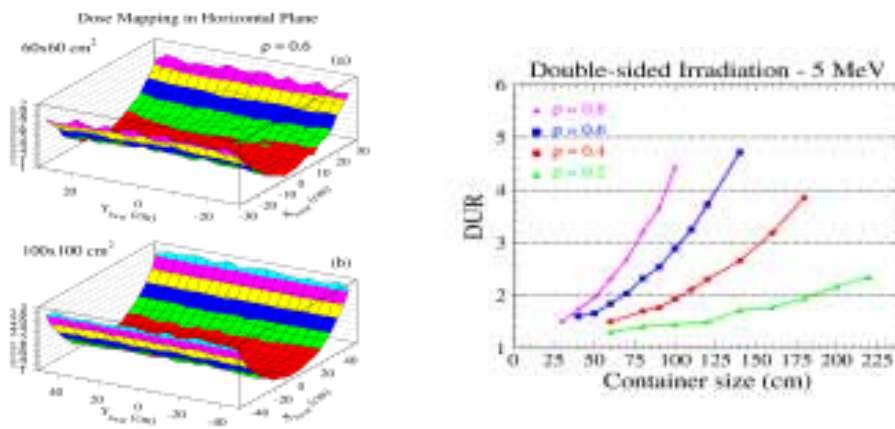

FIG. 5. Dose uniformity ratios (DUR) for double-sided irradiation with 5.0 MeV X rays showing the dependence on product densities and container sizes.

## The Palletron: Main Elements

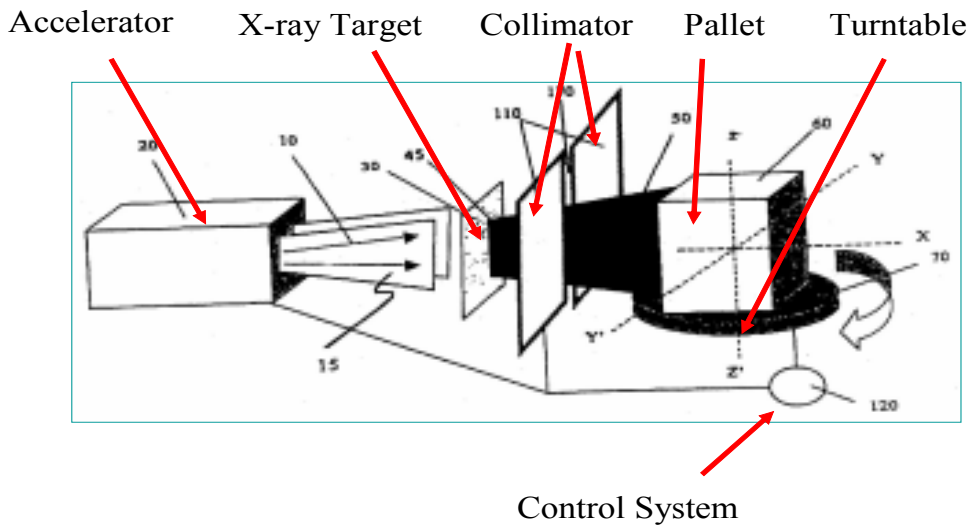

FIG. 6. Diagram of the Palletron system, which consists of a rotating pallet load with adjustable collimators to reduce the dose uniformity ratio for high-density products.

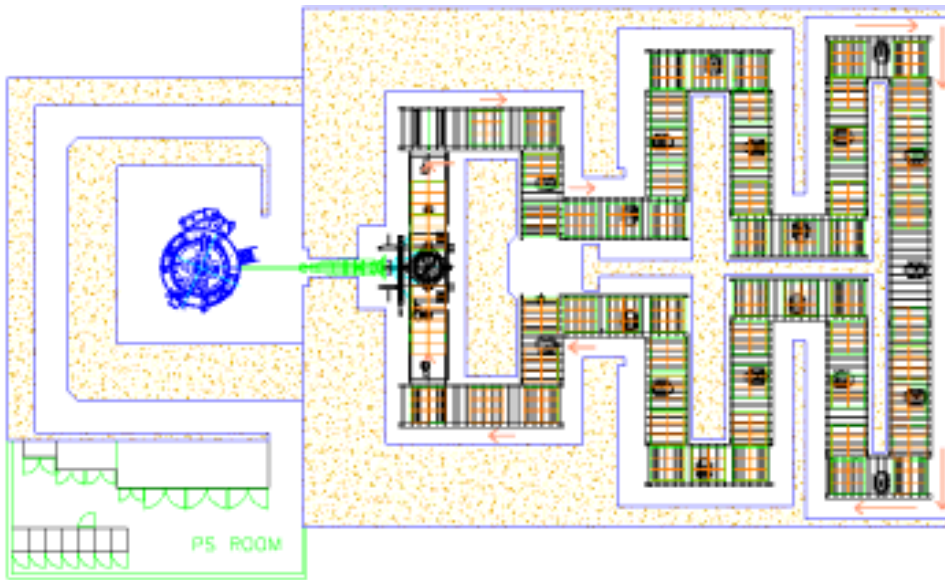

FIG. 7. Plan drawing of a Palletron facility showing a rotating pallet in front of the X ray target with collimators to reduce the dose uniformity ratio for high-density products.

## The Palletron: Basic Concept

### Rotating Cylinder Irradiation With X-rays

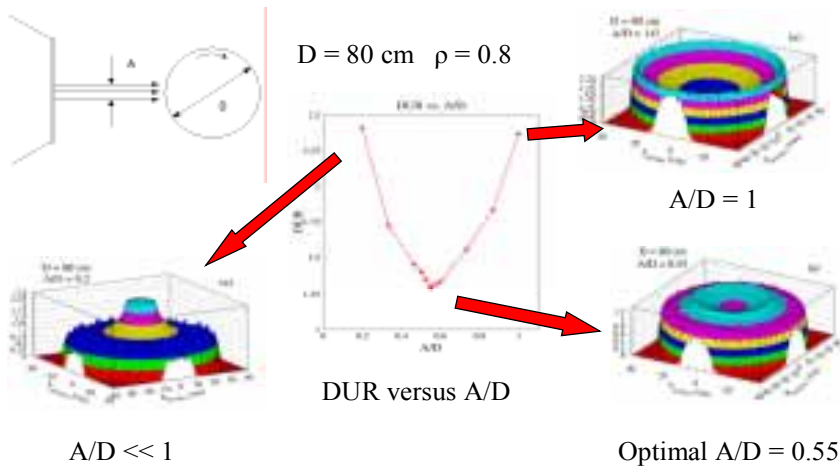

FIG. 8. Basic concept of the Palletron system showing the effects of changing the ratio of the collimator aperture  $A$  to the diameter  $D$  of the irradiated cylinder.

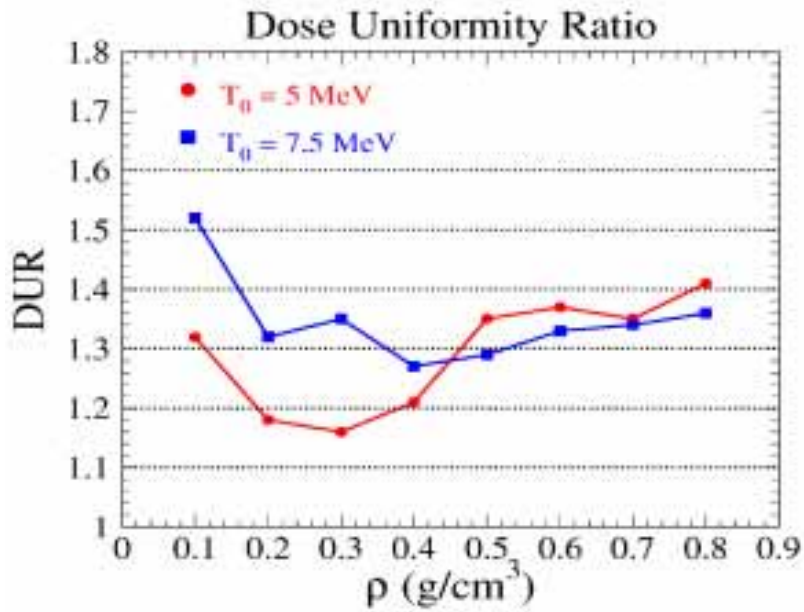

FIG. 9. Palletron performance data showing dose uniformity ratios vs the product density for electron energies of 5.0 MeV and 7.5 MeV.

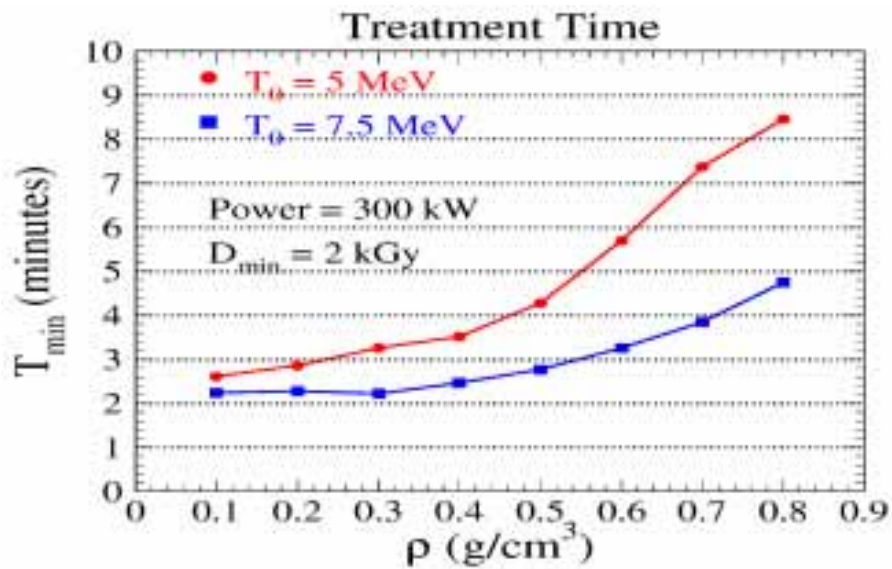

FIG. 10. Palletron performance data showing the treatment time per pallet vs product density for incident electron energies of 5.0 MeV and 7.5 MeV.



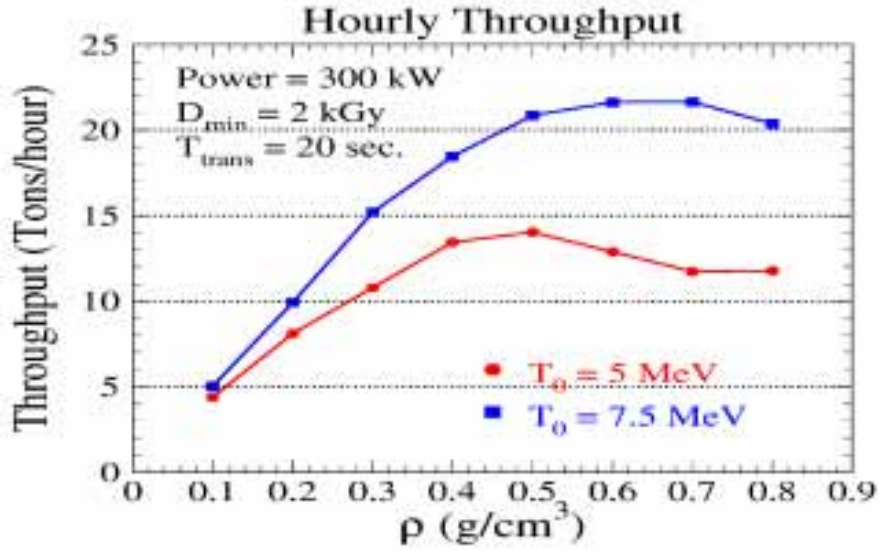

FIG. 11. Palletron performance data showing the hourly throughput rate vs product density for incident electron energies of 5.0 MeV and 7.5 MeV

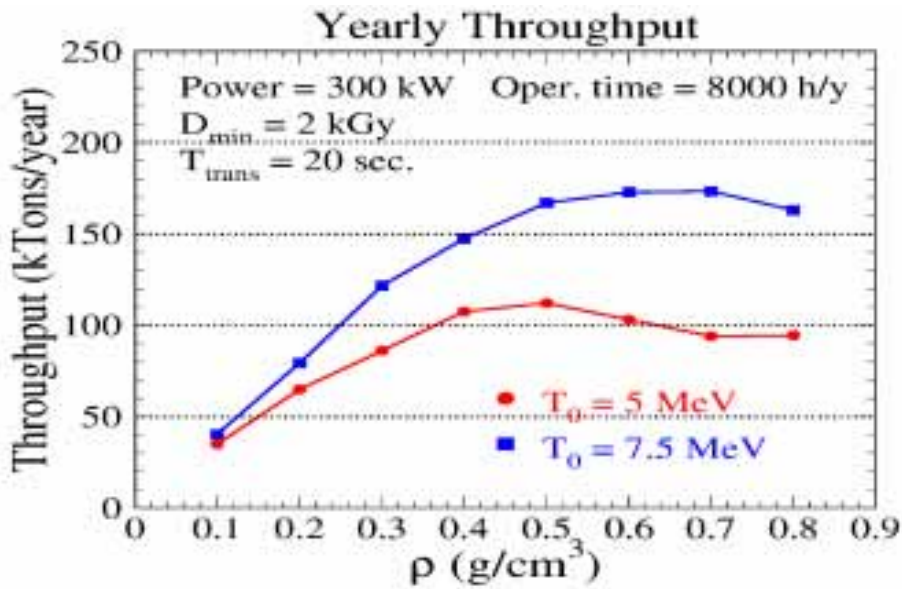

Figure 12. Palletron performance data showing the yearly throughput rate vs product density for incident electron energies of 5.0 MeV and 7.5 MeV.

## REFERENCES

- [1] J.A. HALBLEIB, R.P. KENSEK, T.A. MEHLHORN, G.D. VALDEZ, S.M. SELTZER, M.G. BERGER, ITS Version 3.0, The Integrated TIGER Series of Coupled Electron/Photon Monte Carlo Transport Codes, SAND91-1634, 1992. Also CCC-467/ITS Code Package, available from the Radiation Safety Information Computational Center (RSICC), P.O. Box 2008, Oak Ridge, TN 37831-6362, USA.
- [2] J. MEISSNER, M. ABS, M.R. CLELAND, A.S. HERER, Y. JONGEN, F. KUNTZ, A. STRASSER, X ray treatment at 5 MeV and above, Radiation Physics and Chemistry, Vol. 57, Nos. 3-6, pp. 647-651, 2000.
- [3] M.R. CLELAND, J. MEISSNER, A.S. HERER, E.W. BEERS, Treatment of Foods with High-Energy X rays, American Institute of Physics, AIP Conference Proceedings, Vol. 576, pp. 783-786, 2001.
- [4] S.M. SELTZER, J.P. FARRELL, J. SILVERMAN, *Bremsstrahlung* Beams from High-Power Electron Accelerators for Use in Radiation Processing, IEEE Transactions on Nuclear Science, Vol. NS-30, No. 2, pp. 1629-1633, 1983.
- [5] S.M. SELTZER, Applications of ETRAN Monte Carlo Codes, in Monte Carlo Transport of Electrons and Photons, Eds. T.M. Jenkins, W.R. Nelson and A. Rindi, Plenum Press, NY, 1988.
- [6] M.R. CLELAND AND G.M. PAGEAU, Comparisons of X ray and Gamma Ray Sources for Industrial Irradiation Processes, Nuclear Instruments and Methods in Physics Research B24/25, pp. 967-972, 1987.
- [7] GEANT 3.21, Detector Description and Simulation Tool, CERN Program Library W5013, IT division/CERN, CH-1211 Geneva 23, Switzerland.
- [8] F. STICHELBAUT, The Palletron System, Internal Technical Report, Ion Beam Applications, 2002.
- [9] J. KOTLER, J. BORSA, Product Irradiator for Optimizing Dose Uniformity in Products, U.S. Patent No. 6,504,898 B1, January 7, 2003.
- [10] F. STICHELBAUT, Pallet Irradiation by X Rays: The Blue Heron System, Internal Technical Report, Ion Beam Applications, 2001.
- [11] F. STICHELBAUT, J.-L. BOL, M.R. CLELAND, O. GREGOIRE, A.S. HERER, Y. JONGEN, B. MULLIER, G. ROSE, M. VANDER DONCKT, The Palletron: A High Dose Uniformity Pallet Irradiator With X rays, American Institute of Physics, AIP Conference Proceedings, Vol. 680, pp. 891-894, 2003.
- [12] J.-L. BOL, M.R. CLELAND, A.S. HERER, Y. JONGEN, B. MULLIER, G. ROSE, F. STICHELBAUT, The Palletron: a high dose uniformity pallet irradiator with X rays, in Proceedings of the 2003 International Meeting on Radiation Processing (IMRP), to be published by Radiation Physics and Chemistry, 2004.
- [13] J.-L. BOL, B. MULLIER, F. STICHELBAUT, G. NELSON, G. ROSE, Pallet X ray facility configuration and performances, in Proceedings of the 2003 International Meeting on Radiation Processing (IMRP), to be published by Radiation Physics and Chemistry, 2004.
- [14] M. TAKEHISA, T. SAITO, T. TAKAHASHI, Y. SATO, T. SATO, Characteristics of a Contract Electron Beam and Bremsstrahlung (X ray) Irradiation Facility of Radia Industry, Radiation Physics and Chemistry, Vol. 42, Nos. 1-3, pp. 495-498, 1993.

- [15] Y. AIKAWA, A new facility for X ray irradiation and its application, *Radiation Physics and Chemistry*, Vol. 57, Nos. 3-6, pp. 609-612, 2000.
- [16] T. WATANABE, Best use of high-voltage, high-powered electron beams: a new approach to contract irradiation services, *Radiation Physics and Chemistry*, Vol. 57, Nos. 3-6, pp. 635-639, 2000.
- [17] R.B. MILLER, A Description of SureBeam Food Irradiation Facilities, *American Institute of Physics, AIP Conference Proceedings*, Vol. 680, pp. 871-872, 2003.
- [18] J.-L. BOL, F. MARTIN, B. MULLIER, J. SCHLECHT, R. SMITH, F. STICHELBAUT, X ray dosimetry: comparing Monte Carlo simulations and experimental data, in *Proceedings of the 2003 International Meeting on Radiation Processing (IMRP)*, to be published by *Radiation Physics and Chemistry*, 2004.
- [19] D. BEZIERS, J. DENOST, Composite curing: a new process, *AIAA/ASME/SAE/ASEE 25<sup>th</sup> Joint Propulsion Conference*, Monterey, CA, July 10-12, 1989, *American Institute of Aeronautics and Astronautics Inc.*, 370 L'Enfant Promenade, S.W., Washington, D.C. 20024.
- [20] R.A. GALLOWAY, S. DENEUTER, T.F. LISANTI, M.R. CLELAND, A new 5 MeV – 300 kW Dynamitron for radiation processing, in *Proceedings of the 2003 Meeting on Radiation Processing*, to be published by *Radiation Physics and Chemistry*, 2004.
- [21] Y. JONGEN, M. ABS, E. PONCELET, A.S. HERER, The IBA Rhodotron TT1000, a very high-powered electron beam accelerator, in *Proceedings of the 2003 International Meeting on Radiation Processing (IMRP)*, to be published by *Radiation Physics and Chemistry*, 2004.



## LIST OF PARTICIPANTS

- J. ROSIAK**  
Institute of Applied Radiation Chemistry  
Technical University of Lodz  
Lodz, Poland
- O. GUEVEN**  
Department of Chemistry  
Hacettepe University  
Beytepe  
06532 Ankara, Turkey
- T. CZVIKOVSKY**  
Budapest University of Technology and Economics  
Faculty of Mechanical Engineering  
Polymer Engineering and Textile Technology  
1111 Budapest, Hungary
- M. LAVALLE**  
Istituto per la Sintesi Organica e  
la Fotoreattivita (ISOF) – CNR  
40129 Bologna, Italy
- A. J. BEREJKA**  
4 Watch Way  
Huntington, NY 11743, United States of America
- D. MEISEL**  
Radiation Laboratory and Dept. of Chemistry  
University of Notre Dame  
Notre Dame  
IN, 46556, United States of America
- G. HUG**  
University of Notre Dame  
Notre Dame  
IN 46556, United States of America
- J. LaVERNE**  
Radiation Laboratory  
University of Notre Dame  
Notre Dame  
IN 46556, United States of America
- Z. P. ZAGORSKI**  
Institute of Nuclear Chemistry and  
Technology (INCT)  
Dept. of Radiation Chemistry & Technology  
03-195 Warsaw, Poland
- M. R. CLELAND**  
Ion Beam Applications  
20 Little Lane  
Hauppauge, NY 11788, United States of America
- A. G. CHMIELEWSKI**  
Industrial Applications and Chemistry Section  
Division of Physical & Chemical Sciences  
Department of Nuclear Sciences and Applications  
International Atomic Energy Agency  
1400 Vienna, Austria

