

BIOLÓGIA és BIOTECHNOLÓGIA

2. rész

Előadó: Ballagi András, Ipari Professzor
Richter Gedeon NyRt. - BME

Írásos segédanyag található a:

<http://oktatas.ch.bme.hu>
/oktatas /konyvek /mezgaz
/Biol-biotech-vegyszer-MSc címen



Itt tartunk:

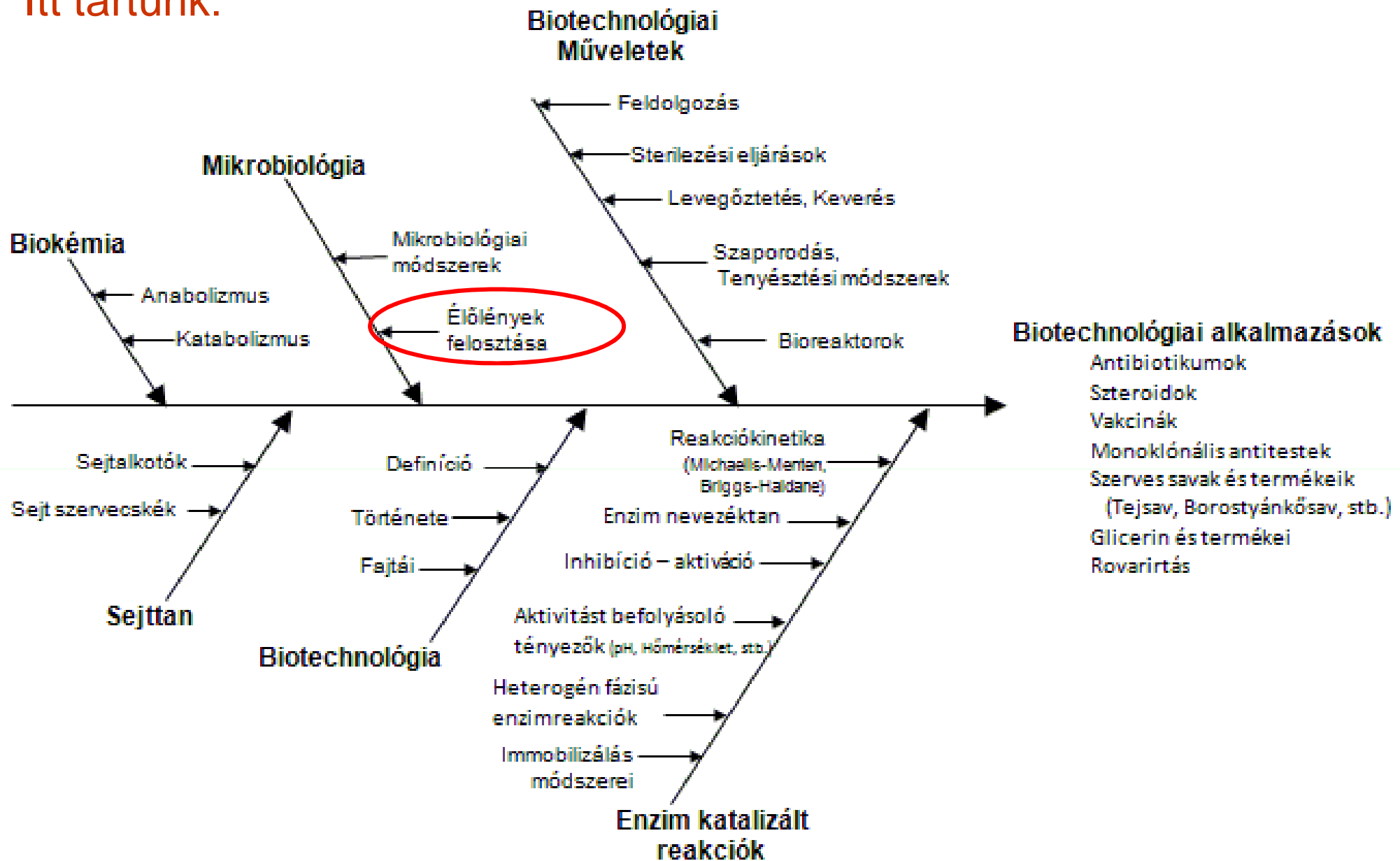

Why study Microbiology

Microbes are related to all life.

- In all environments
- Many beneficial aspects
- Related to life processes (food web, nutrient cycling)
- Only a minority are pathogenic.
- Most of our problems are caused by microbes

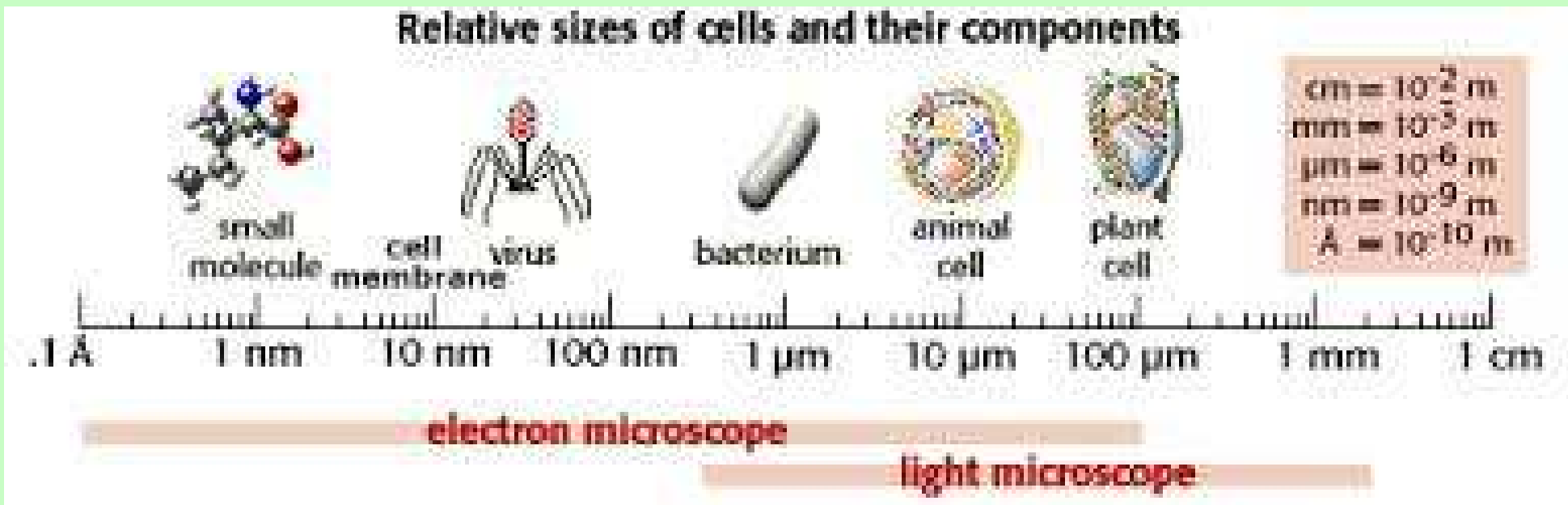

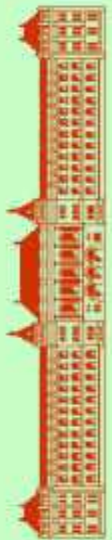
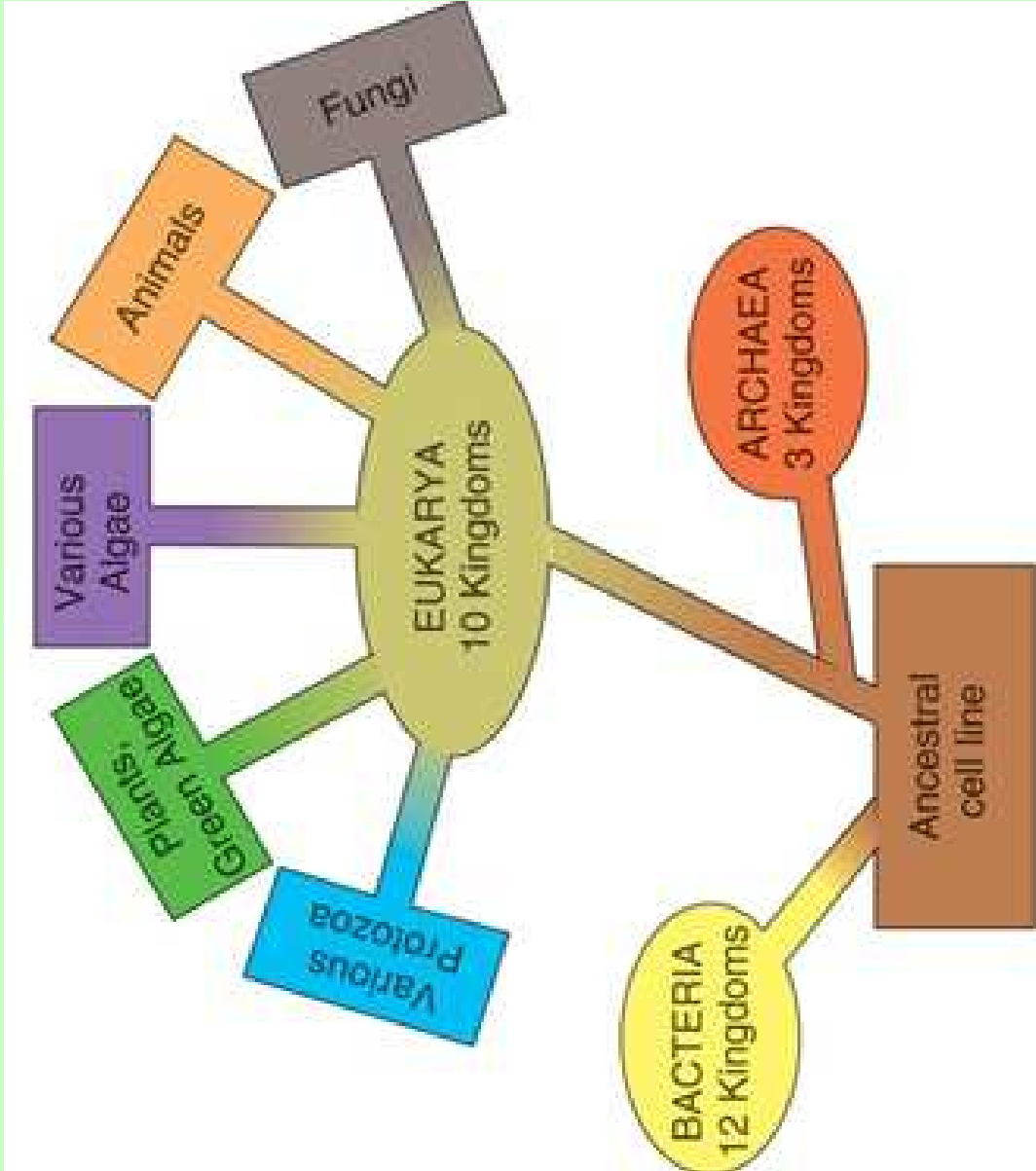

Bacteria

Prokaryotes

Peptidoglycan cell walls

Binary fission

For energy, use

organic chemicals,

inorganic chemicals,

photosynthesis

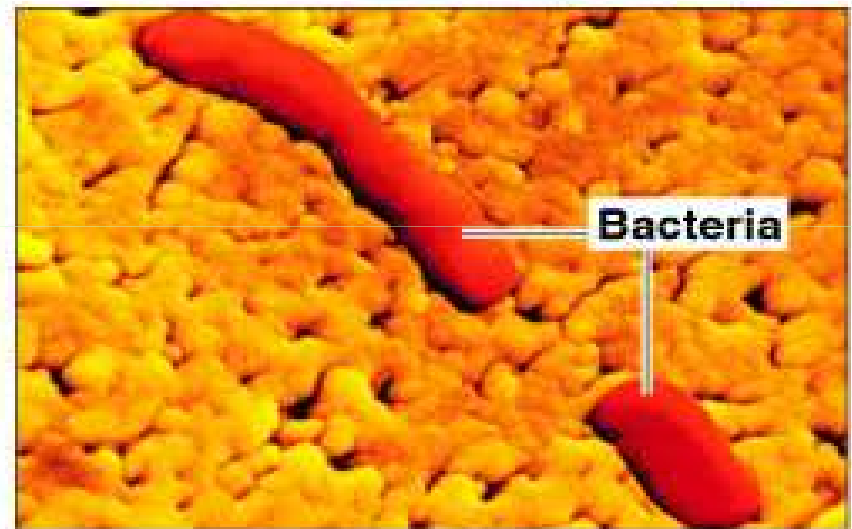

(a)



Archaea

Prokaryotic

Lack peptidoglycan

Live in extreme environments

Include:

- Methanogens

- Extreme halophiles

- Extreme thermophiles

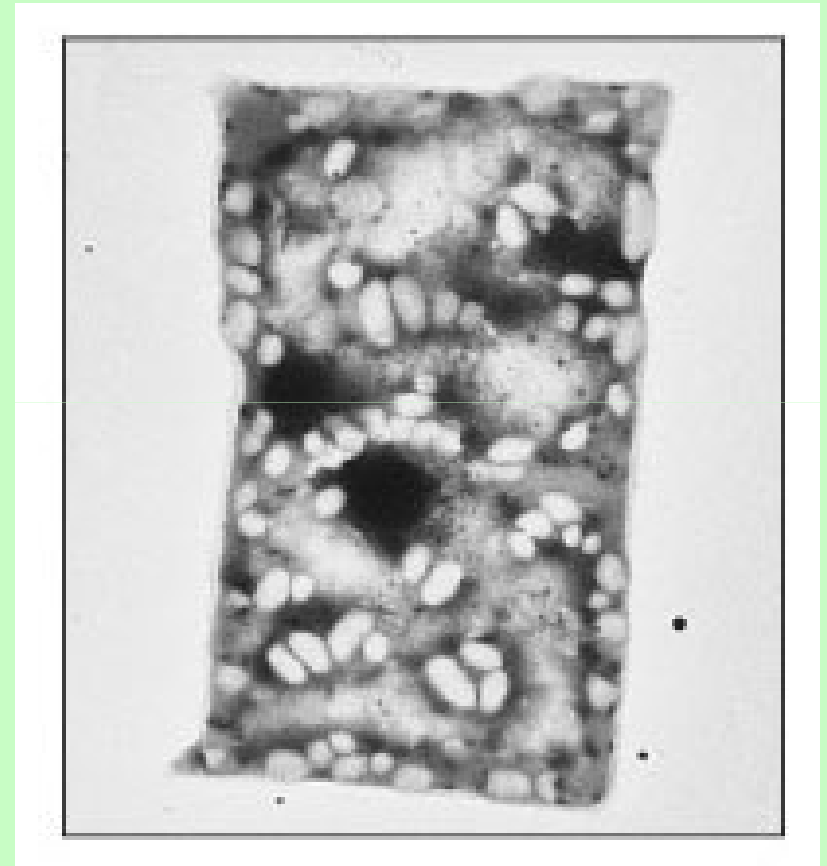

Fungi

Eukaryotes

Chitin cell walls

Use organic chemicals for energy

Molds and mushrooms are multicellular consisting of masses of mycelia, which are composed of filaments called hyphae

Yeasts are unicellular

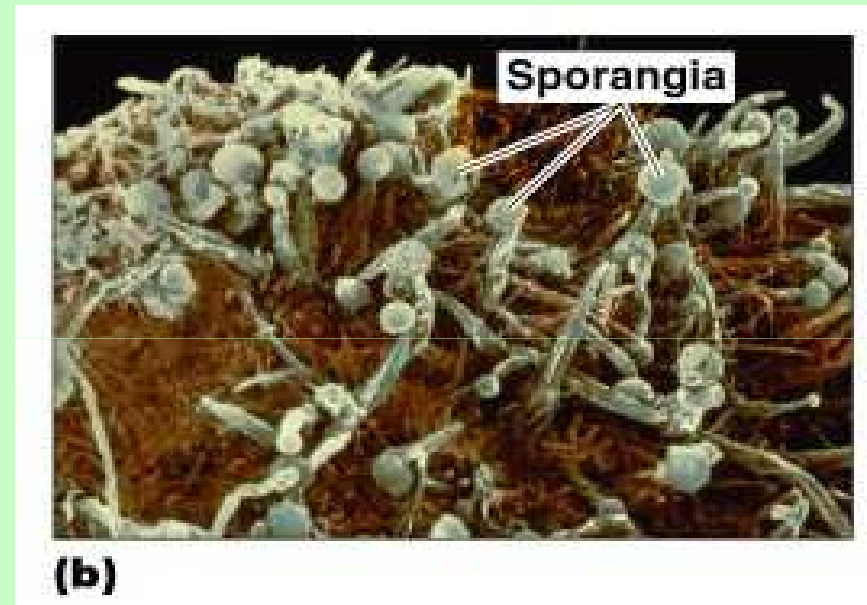

Protozoa

Eukaryotes

Absorb or ingest organic chemicals

May be motile via pseudopods, cilia, or flagella

Some of them parasites



Algae

Eukaryotes

Cellulose cell walls

Use photosynthesis for energy
(primary producers)

Produce molecular oxygen and
organic compounds

Metabolically diverse

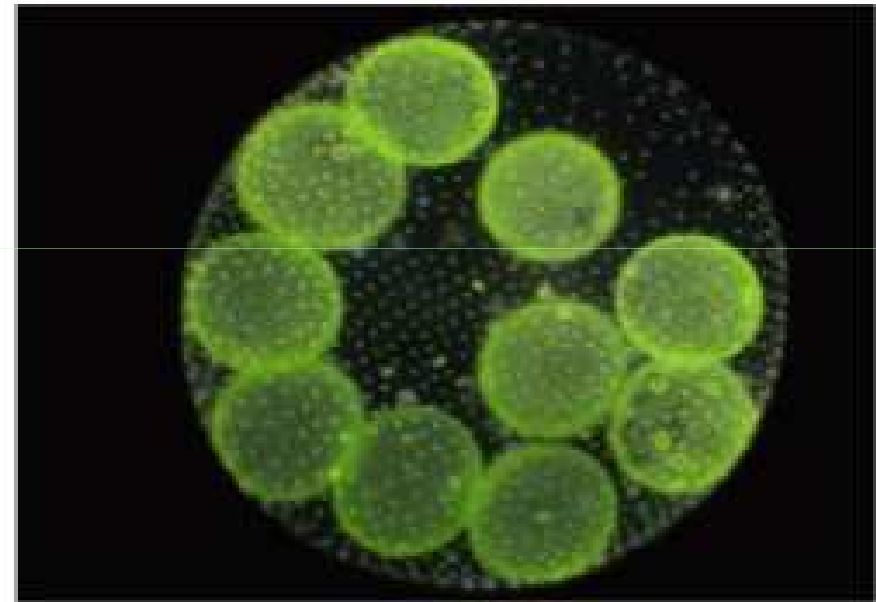

(d)



Viruses

Acellular

Consist of DNA *or* RNA core

Core is surrounded by a protein coat

Coat may be enclosed in a lipid envelope

Viruses are replicated only when they are in a living host cell



Multicellular Animal Parasites

Eukaryote

Multicellular animals

Parasitic flatworms and round worms are called helminths.

Microscopic stages in life cycles.



Nomenclature

Carolus Linnaeus (1735)

Binomial (scientific) nomenclature

Gives each microbe 2 names

Genus - noun, always capitalized

species - adjective, lowercase

Both italicized or underlined

Staphylococcus aureus (*S. aureus*)

Bacillus subtilis (*B. subtilis*)

Escherichia coli (*E. coli*)

When two organisms share a common genus are related.



Mikroökológia

Élőhelyek: levegő, víz, talaj

Életformák: szaprofita, szimbionita, kommenzalista, parazita

Életkörülmények: hőmérséklet tolerancia

(pszichrofil, mezofil, termofil)

pH tolerancia (acidophil, neutrophil, alkalophil)

Sótűrés (ozmotolerancia)

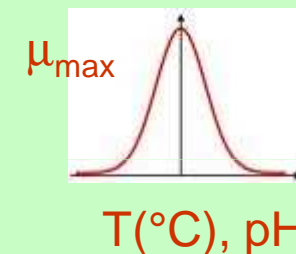

Mikrobák szerepe a bioszférában: fotoszintetizálók (CO₂-t megköthetnek),

Energiát termelhetnek

lebontók: C, N, P, S körforgalomba visszajuttatása



Keletkezhet spontán módon élet?

The hypothesis that living organisms arise from nonliving matter is called spontaneous generation. According to spontaneous generation, a “vital force’ forms life.

The alternative hypothesis, that the living organisms arise from preexisting life, is called biogenesis.



Keletkezhet spontán módon élet?

The belief in the spontaneous generation of life from nonliving matter was introduced by **Aristotle**, who lived around 350 BC.

According to Aristotle, it was:

“readily observable that aphids arise from the dew which falls on plants, fleas from putrid matter, mice from dirty hay.”

This belief remained unchallenged for more than 2000 years.

Until...



Aristotle: 384 - 322 B.C.



Keletkezhet spontán módon élet?

Experiments on Flies

First to formally challenge the accepted belief of spontaneous generation.

Redi's Question: Where do maggots come from?

Hypothesis: Maggots come from flies.

Experiment: Redi put meat into three separate jars.

Jar-1

- Left open
- Maggots developed
- Flies were observed laying eggs on the meat in the open jar

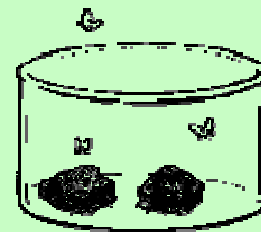

Jar-2

- Covered with netting
- Maggots appeared on the netting
- Flies were observed laying eggs on the netting

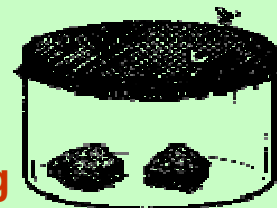

Jar-3

- Sealed
- No maggots developed

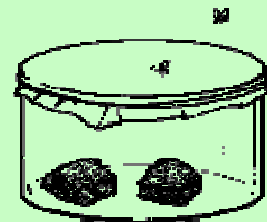

Francesco Redi,
Italian physician,
naturalist & poet,

1626 – 1697.



Keletkezhet spontán módon élet?

What causes tiny living things to appear in decaying broth?

Needham's Hypothesis: Spontaneous generation.

Spallazani's Hypothesis: Microbes come from the air.

Boiling will kill them.

Needham >

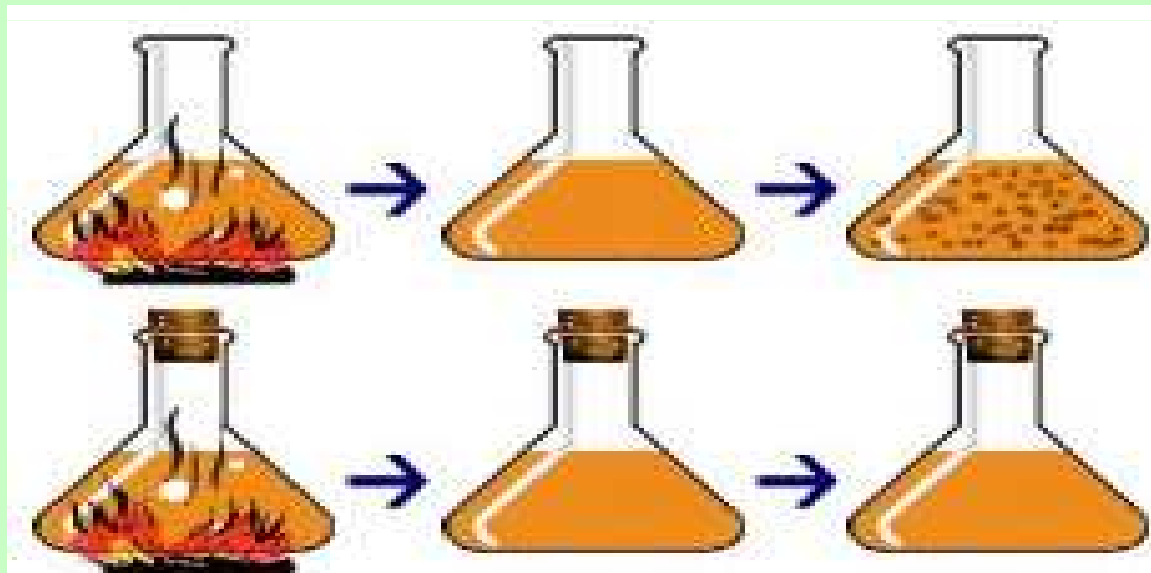

1713 - 1781

Spallazani >

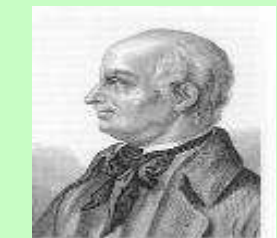

1729 - 1799



Keletkezhet spontán módon élet?

Louis Pasteur és az Ipari Microbiológia

Pasteur's observations:

Are these non-living blobs or living microbes?

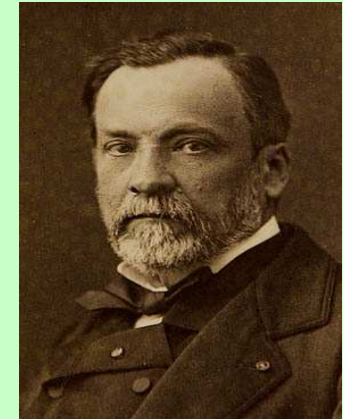

1822 - 1895

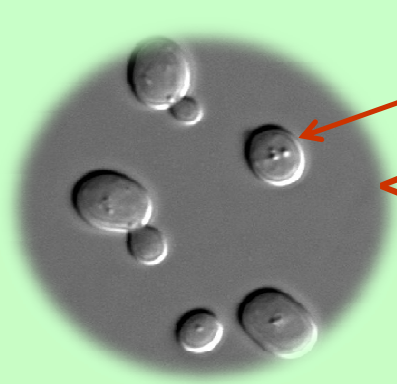

< yeast + grapes = yummy wine 😊 (ethanol)

bacteria + grapes = spoiled wine ☹️ (lactic acid) >

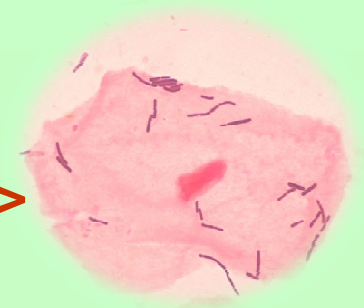

Fermentation and Pasteurization

Pasteur showed that microbes are responsible for fermentation.

Fermentation is the conversion of sugar to alcohol to make beer and wine.

Microbial growth is also responsible for spoilage of food.

Bacteria that use alcohol and produce acetic acid spoil wine by turning it to vinegar (acetic acid).

Pasteur demonstrated that these spoilage bacteria could be killed by heat that was not hot enough to evaporate the alcohol in wine. This application of a high heat for a short time is called **pasteurization.**



Elméletek a betegségek mikrobiális eredetéről

Oliver Wendell Holmes (US)

Believed death following childbirth (puerperal fever) often caused by the material on hands of midwives or attending physicians.

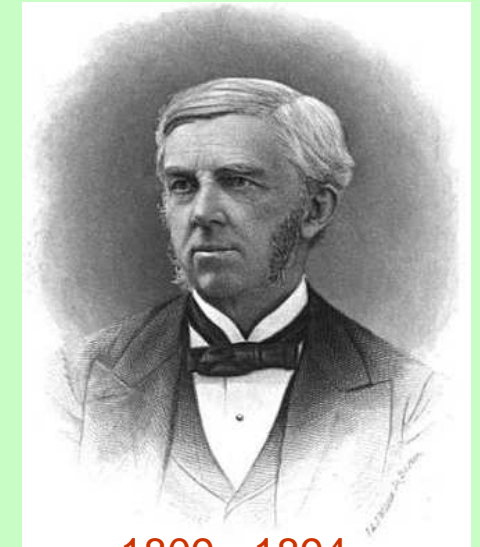

1809 - 1894

Semmelweis Ignác (Ausztria – Magyarország)

Noticed death rates higher in maternity wards staffed by medical students than in those attended by midwives. Death rates decreased in summer.

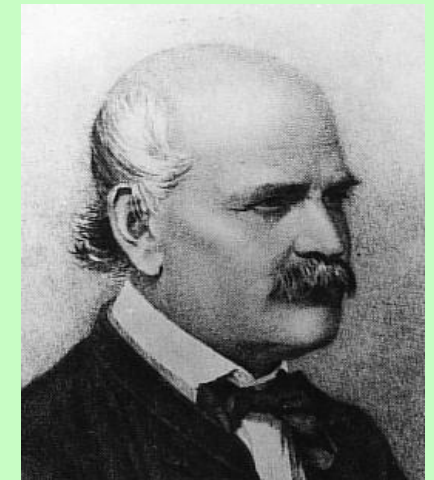

1818 - 1865



Elméletek a betegségek mikrobiális eredetéről

Robert Koch

Experimented with medium to grow bacteria on.

He tried gelatin, but it did not work.

Wife of colleague recommended agar (a gelatin-like product derived from seaweed).

Didn't melt, and bacteria couldn't digest it.

He could also add various nutrients necessary to grow certain organisms.

Koch originated use of a two part dish for growing bacteria „Petri dish” named after Julius Petri, a German bacteriologist), and a technique for isolating pure bacterial colonies.

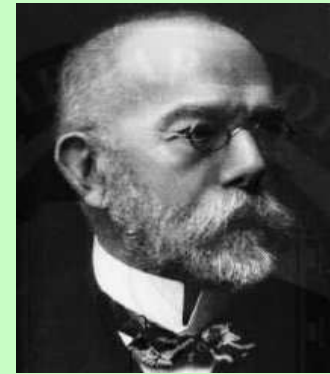

1843 - 1910

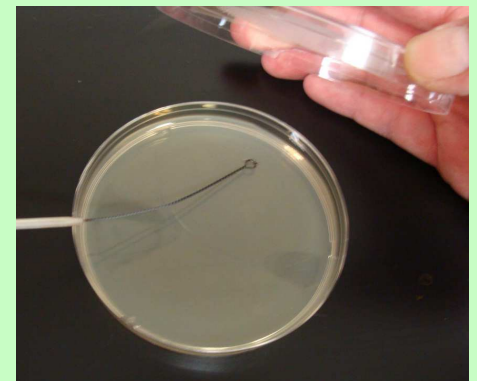

Elméletek a betegségek mikrobiális eredetéről

Koch's Postulates

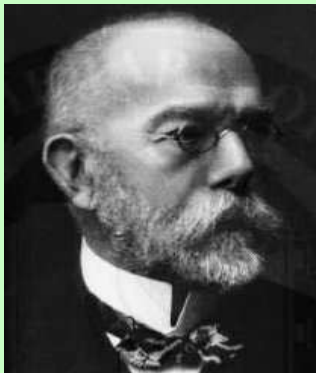

1843 - 1910

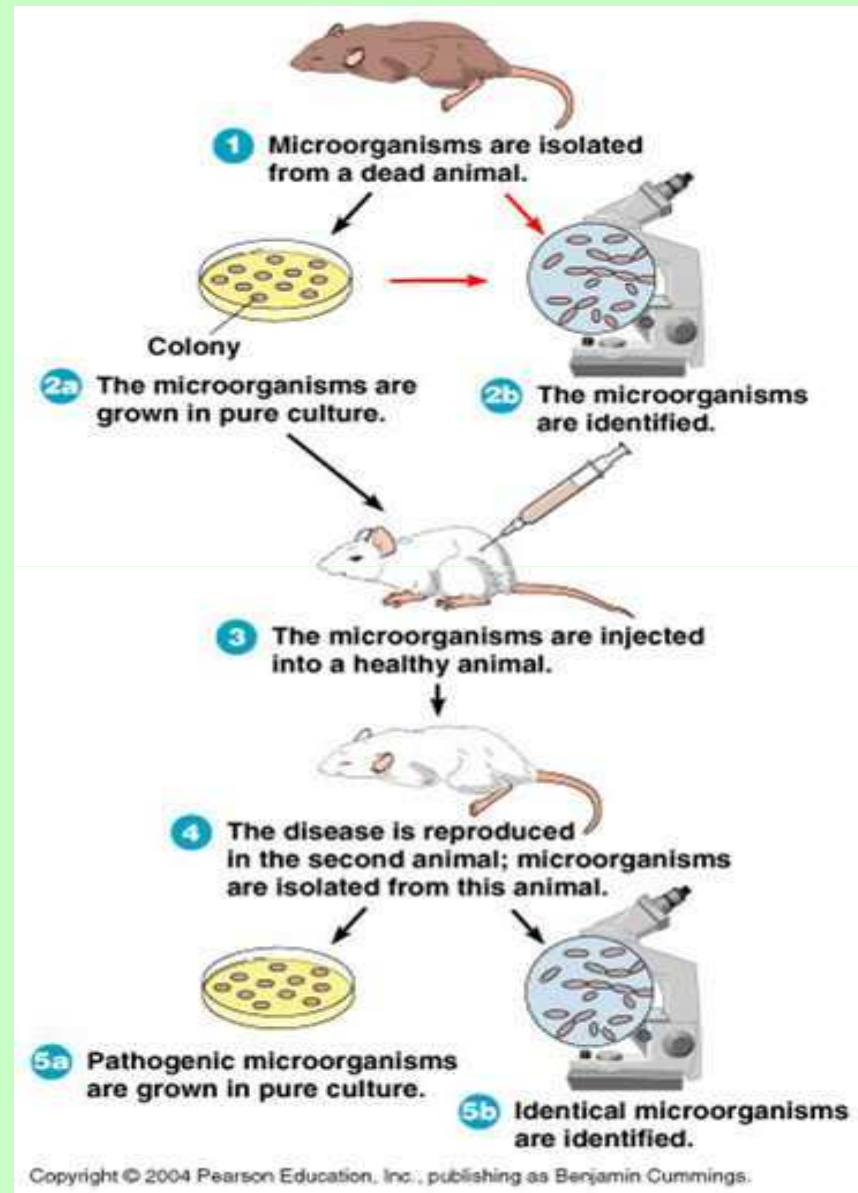

Az immunológia kezdetei – Edward Jenner

Was aware of farm workers' belief that if you had cowpox in past, you wouldn't get smallpox.

Cowpox caused mild discomfort, aching, a few pustules, some swelling...symptoms that disappeared in a few days.

In contrast, smallpox caused massive disfigurement, sometimes blindness, and often death.

Jenner, in the late 1700s, made small incisions or punctures with cowpox material in arms of human subjects in order to prevent smallpox.

Jenner's works are said to have saved more lives than the efforts of any other person in history.



1749 - 1823



Az immunológia kezdetei – Luise Pasture

Individuals who recover from an infectious disease sometimes immune from future attack.

Prompted Pasteur to try to find a way to prevent fowl cholera in chickens.

Colleague of Pasteur's postponed inoculations of cholera into a group of chickens, a remarkable discovery resulted.

Inoculation with these neglected cultures made the chickens immune to fowl cholera.

The microbes had been weakened or attenuated.

Pasteur also modified other organisms (anthrax and the virus causing rabies). Ultimately created inoculation procedures of vaccinations.

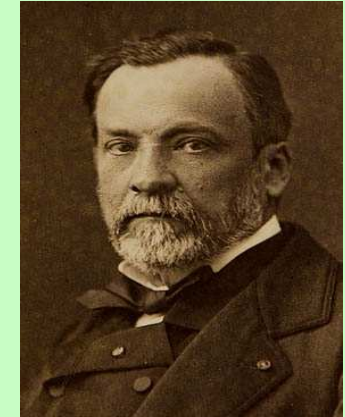

1822 - 1895

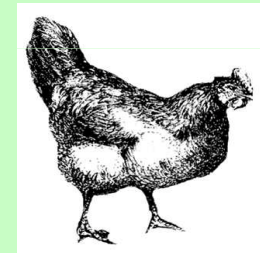

A modern kemoterápia megjelenése

- Treatment with chemicals is chemotherapy.
- Chemotherapeutic agents used to treat infectious disease can be synthetic drugs or antibiotics.
- Antibiotics are chemicals produced by bacteria and fungi that inhibit or kill other microbes.
- Quinine from tree bark was long used to treat malaria.
- 1910: Paul Ehrlich developed a synthetic arsenic drug, salvarsan, to treat syphilis.
- 1930s: Sulfonamides were synthesized.



Az antimikrobiális szerek felfedezése

Alexander Fleming (1881 – 1955), a Scottish biologist and pharmacologist, observed bacterial staphylococci colonies disappearing on plates contaminated with mold.



Fleming extracted the compound from the mold responsible for destruction of the bacterial colonies.

The product of the mold was named penicillin, after the *Penicillium* mold from which it was derived.

Nobel Prize in Physiology of Medicine in 1945.

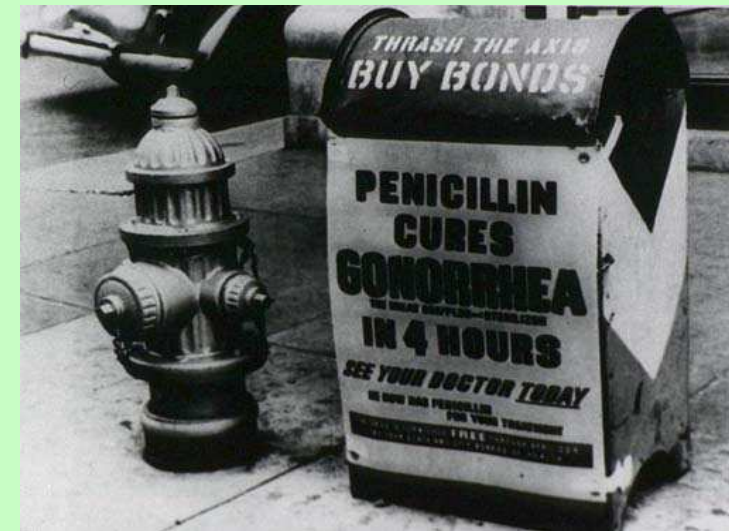

A penicillin gátló hatása

Fleming 1928-ban egy *Staphylococcus* törzs tenyésztésével foglalkozott a londoni St. Marry's kórház fertőző betegségek osztályán. Háromhetes szabadságáról visszatérve azt tapasztalta, hogy az asztalán felejtett tenyészet penésszel fertőződött meg. (Valami ehhez hasonló látvány fogadta.) A fertőzés körül a baktériumok nem növekedtek.

Ez vezetett ahhoz a felfedezéshez, hogy bizonyos gombafajok a baktériumok szaporodását gátló anyagokat termelnek.

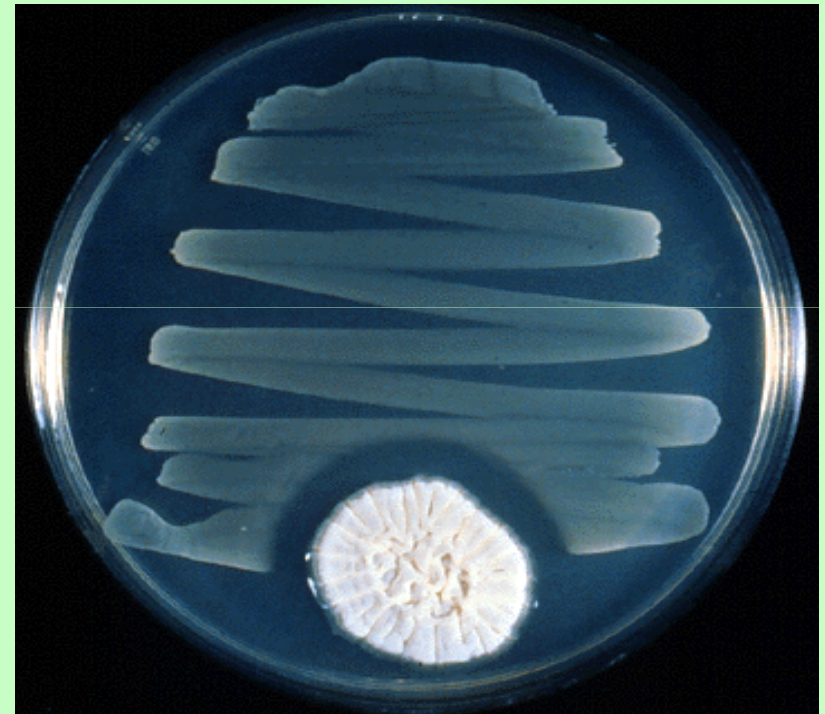

A penicillin gátló hatása

Az antibiotikumok hatásosságát mai napig úgy határozzák meg, hogy lemérik annak a gyűrűnek az átmérőjét, amelyben gátolta a baktérium növekedését.

Később – feltételezve, hogy találhatnak más gombákat, amik még több penicillin kibocsátására képesek szűrővizsgálatokat alkalmazva választották ki azt a *Penicillium chrysogenum* (NRRL1951) törzset, amelyet egy rothadt sárgadinnyéről izoláltak, és ez a törzs lett a szülő-egyede mindazon ipari mutáns törzseknek, amelyekkel jelenleg a világ igen sok országában a penicillint előállítják.

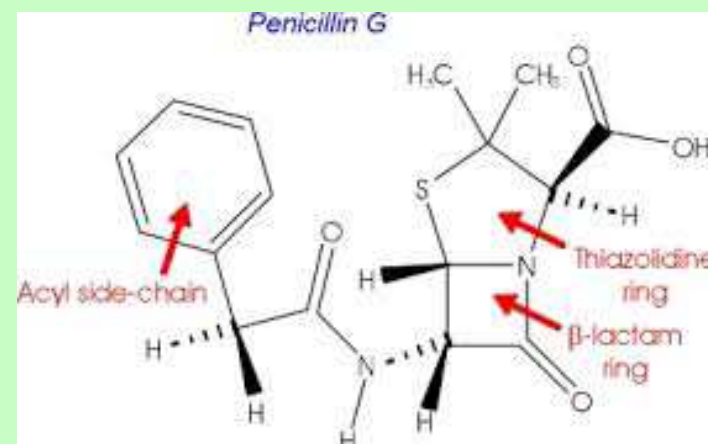
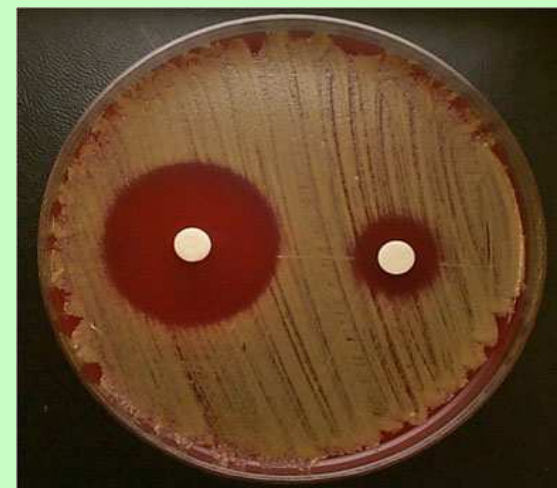

Fleming tudatában volt felfedezésének világméretű jelentőségére, ezért eljárását és a penicillint nem engedte szabadalmaztatni, hanem a gyógyítás érdekében az 1950-es évektől kezdve a világ minden országának rendelkezésére bocsátotta.

Magyarországon maga Fleming adta át a penicillin termelő törzsét az Országos Közegészségügyi Intézetnek.

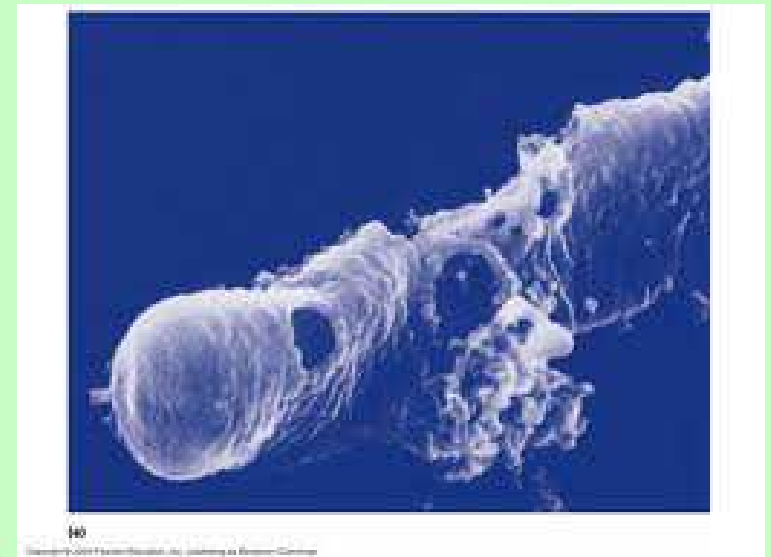
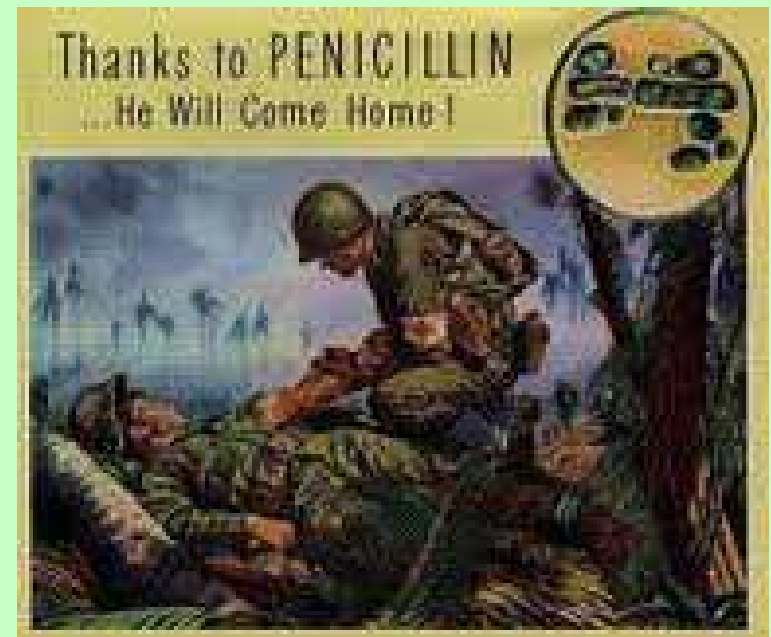

Modern Developments in Microbiology

Bacteriology is the study of bacteria.

Mycology is the study of fungi.

Parasitology is the study of protozoa and parasitic worms.

Recent advances in genomics, the study of an organism's genes, have provided new tools for classifying microorganisms.

Transcriptomics is looking at the m-RNA as gene products

Proteomics is looking at the protein as gene products



Itt járunk:

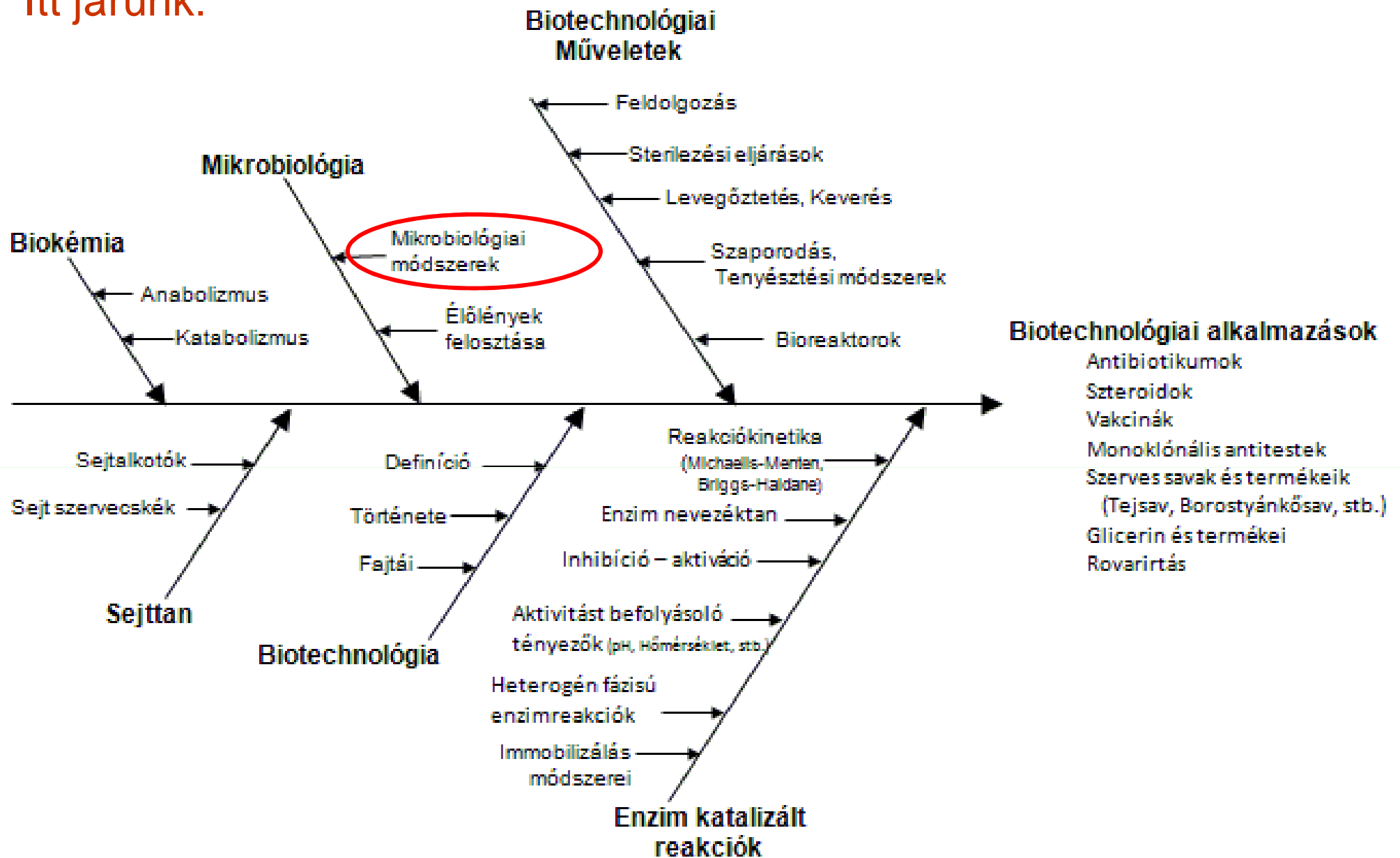

Mikrobiológiai módszerek

Izolálás

A technológia alapját képező mikroorganizmus megtalálása.

Beszerezési források: a mikroorganizmusok természetben lévő biotópjából – talaj, iszap, víz, levegő, élő szervezetek

Isolate strains from extreme or unusual environments

Hope such strains may be capable of producing new metabolites.

For instance, microorganisms from high altitudes, cold habitats, sea water, deep sea, deserts, geysers, and petroleum fields are being examined



Mikrobiológiai módszerek

Kényelmes beszerzési források: a törzsgyűjtemények

American Type Culture Collection (ATCC). Rockville, Maryland, U.S.A.,

NRRL: US Department of Agriculture, Northern Regional Research Center

NCIMB: National Collection of Industrial and Marine Bacteria Ltd.

FERM: Fermentation Research Institute, Tokyo, Japan,

CMI: Commonwealth Mycological Institute, Kew, Surrey, England,

ECACC: European Collection of Cell Cultures

C.I.P.: Colletion de Bactéries de l'Institut Pasteur

OKI: Orvosi Baktériumok Magyar Nemzeti Gyűjteménye

Kertészeti és Élelmiszeripari Egyetem: Mezőgazdasági és Ipari Mikroorganizmusok Nemzeti Gyűjteménye



Mikrobiológiai módszerek

Izolálás

Szilárd minta → ez a leggyakoribb, mert itt legnagyobb a diverzitás
minta → közvetlenül Petri csészére
minta → vizes szuszpenzió → Petri csészére
minta felszínéről steril vattával

Inkubálás



Folyadék minta → esetleges hígítás → esetleges dúsítás előinkubációval



→ szűrés+agar+inkubálás

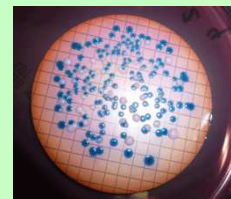
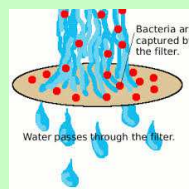

Levegő minta → szűrés+agar+inkubálás



Mikrobiológiai módszerek

**Agar is a complex polysaccharide isolated from red algae
solid at room temp, liquefies at boiling (100°C),
does not resolidify until it cools to 42°C
provides framework to hold moisture & nutrients
not digestible for most microbes**



Mikrobiológiai módszerek

Mikroorganizmusok egy természetes mintából

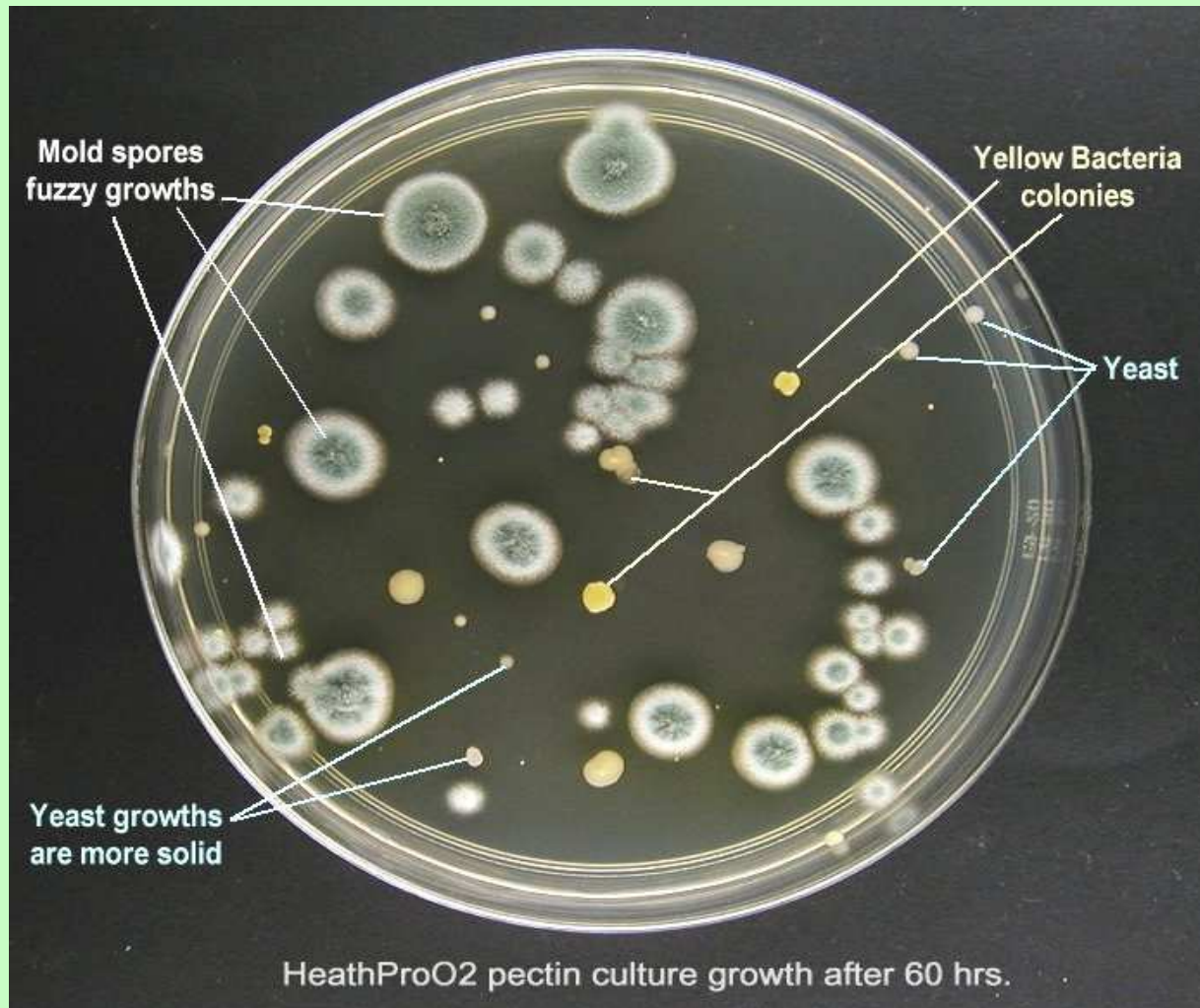

Mikrobiológiai módszerek

Egyetlen sejtől származó kolónia előállítása

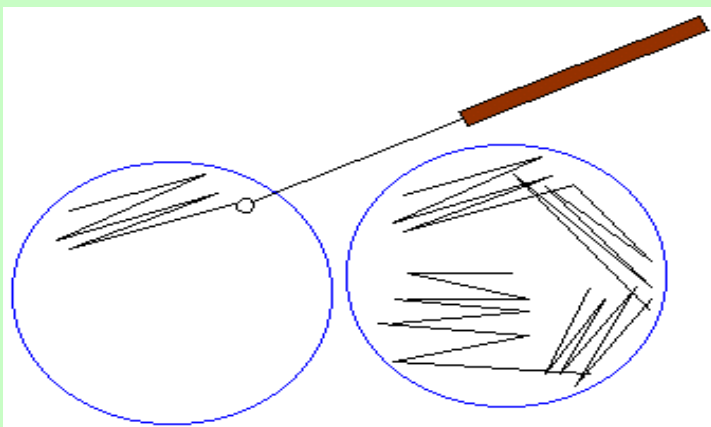

Mikrobiológiai módszerek

Izolálás és screenelés kézi módszerrel

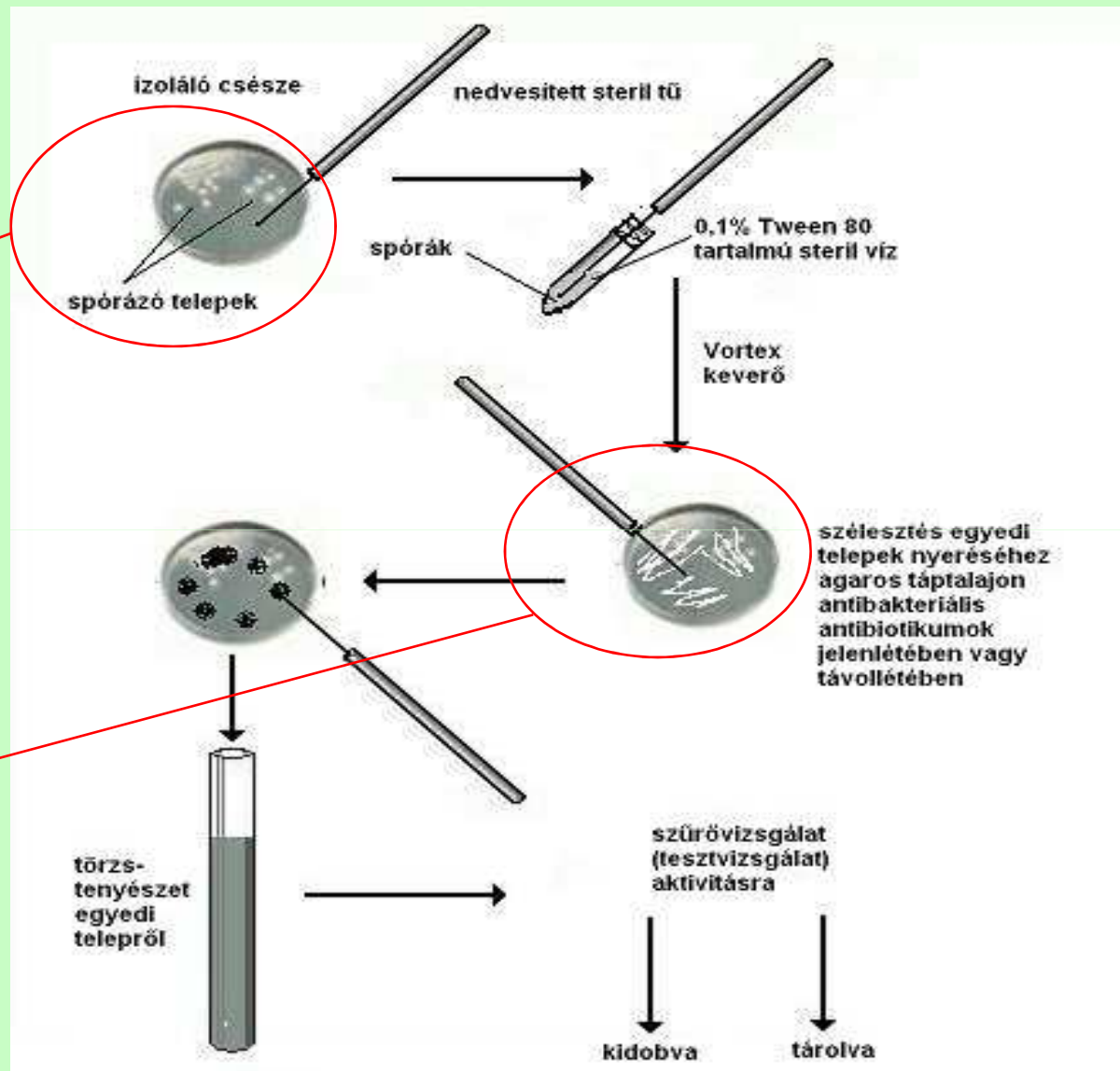
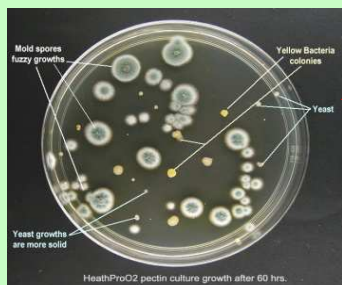

Mikrobiológiai módszerek

ENRICHMENT MEDIA

Enriched media are media that have been supplemented with highly nutritious materials such as blood, serum or yeast extract for the purpose of cultivating fastidious organisms.

Eg., Blood agar, Chocolate agar



Mikrobiológiai módszerek

Szelektív média:

- pl.: antibiotikum → csak gombák nőnek
- antifungális szerek → baktériumok nőnek
- savanyú közeg → élesztők nőnek
- speciális tápanyag → pl. metanol hasznosítók nőnek
- aminósavak hiánya → heterotrófok nőnek

Inkubálás



Eosin-methyleneblue agar (EMB)
Contains methyleneblue,
toxic for Gram+ bacteria,
allowing only the growth of Gram– bacteria



Mikrobiológiai módszerek

Differential media:

...are widely used for differentiating closely related organisms or groups of organisms. Because of the presence of certain dyes or chemicals in the media, the organisms will produce certain characteristic changes or growth patterns that are used for identification or differentiation of microorganism.

Eg., Mac Conkey (MCK) agar, Eosin Methylene Blue (EMB) agar

Enterobacter cloacae
Lactose fermenter

The gram-positive bacteria
Staphylococcus aureus

Pseudomonas aeruginosa
lactose nonfermenter (pink colonies)

Escherischia coli typical lactose fermenter (colonies with green metallic sheen)

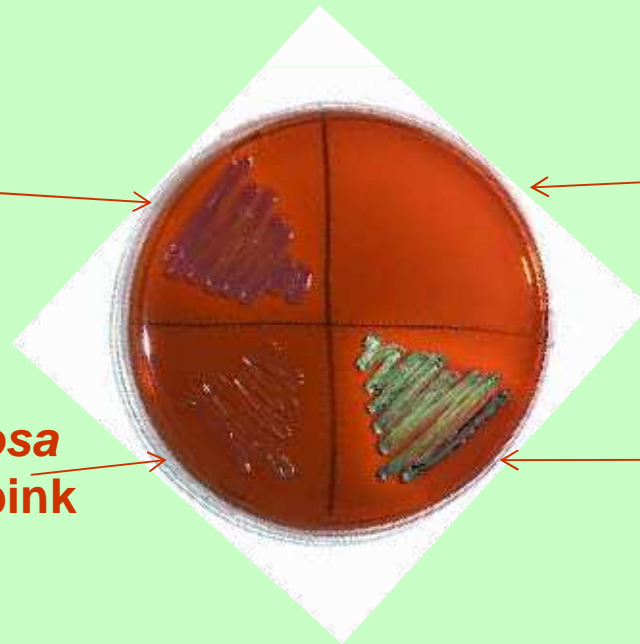

Mikrobiológiai módszerek

Screening

Keresni azokat a törzseket az izolátumok között, amelyek:

Nagy termelőképességgel rendelkeznek

Stabil biokémiai és genetikai tulajdonsággal rendelkeznek (80-100 gen.)

Nem termelnek káros melléktermékeket

Könnyen tenyészthetők nagy léptékben is (mert pl. elég gyorsan nőnek)

Egy példa: Tejsavtermelő baktérium törzs kiválasztása

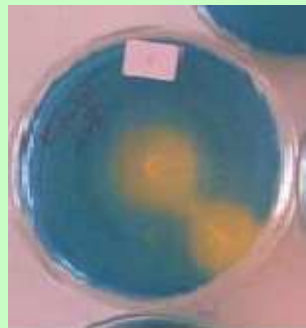

**Tápoldat
+ pH függő
festék
+ agar**



**Tápoldat
+ CaCO₃
+ agar**



Mikrobiológiai módszerek

High Throughput Screening (HTS)

Nagy számban, automatizált módon keresni termelő törzseket az izolátumok között:

Lépései:

1. Egy sejtől indult kolónia azonosítása képelemzéssel
2. A kolónia érintése steril eszközzel (pipettahegy, pálca, kacs), v. mikrocspesz alkalmazása mikroszkóp alatt.
3. A kolónia átvitele friss folyékony tápoldatba
4. Tenyésztés (inkubáció)
5. In-line v. at-line analízis sejtszámra, termékre, vagy intermedierre
6. A legjobb termelők elkülönítése további vizsgálatra

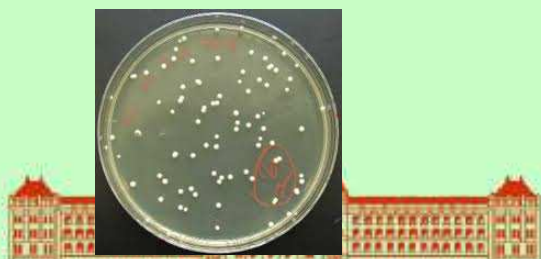
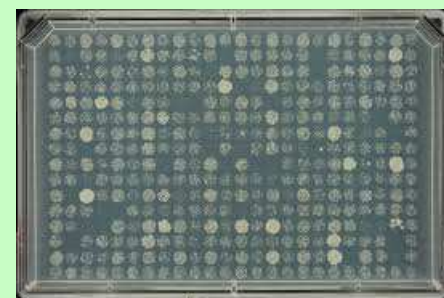
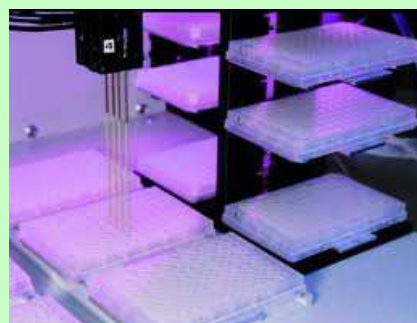
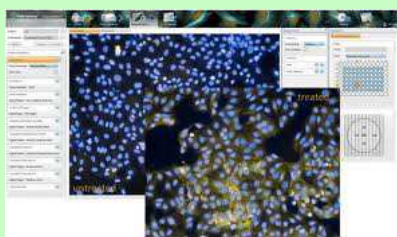

Mikrobiológiai módszerek

High Throughput Screening (HTS) work station

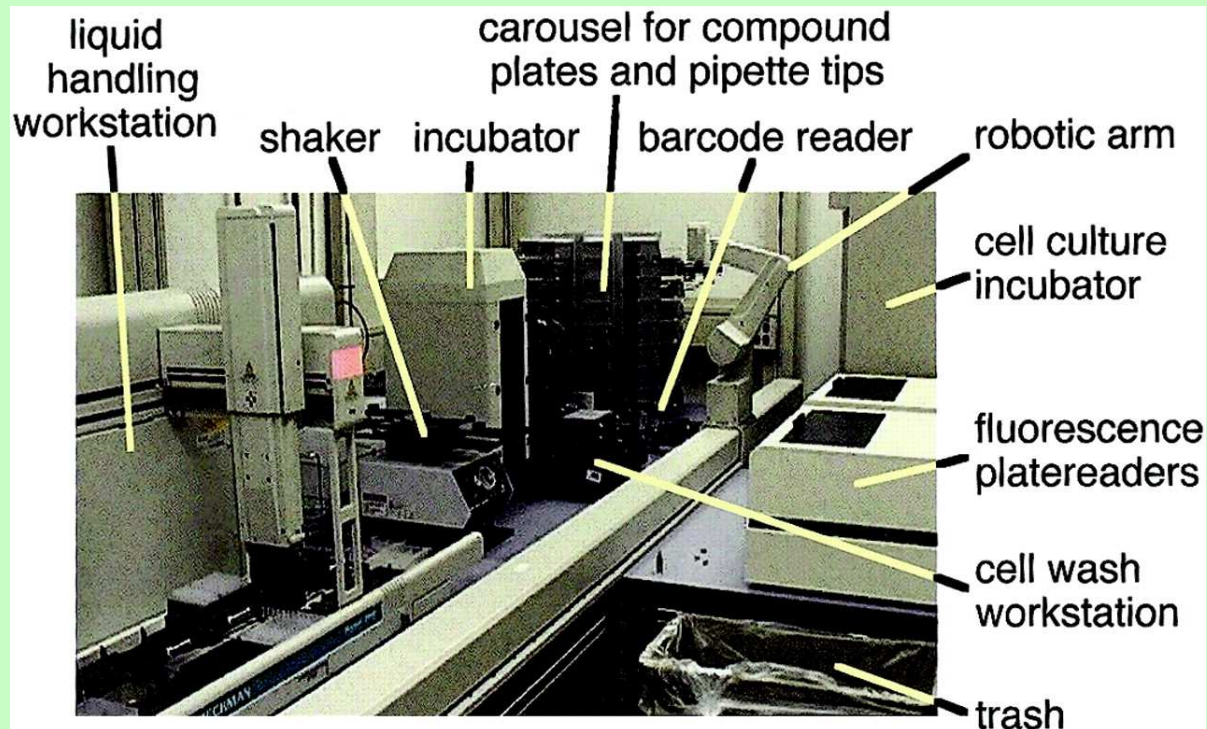

Mikrobiológiai módszerek

High Throughput Screening (HTS) multi work station

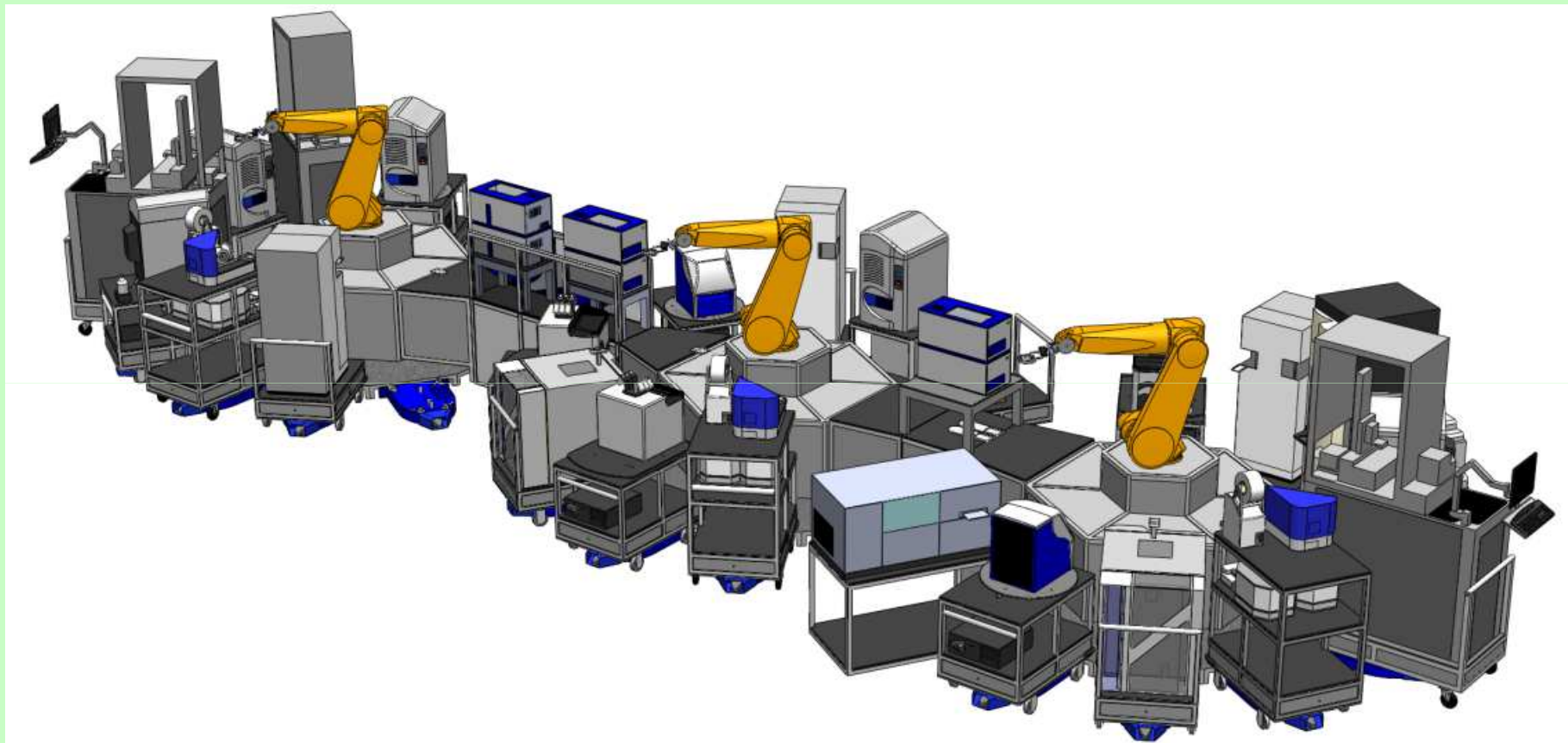

Mikrobiológiai módszerek

Identifikáció

Fenotípusosan:

makroszkópikus tul.: telep színe, nagysága, formája

mikroszkópikus tul.: sejt alakja, csoportosulása, mozgásszerve,
sejtmagja, sejtfala (Gram festés, más festések)

biokémiai tul.: oxidáz próba, aerob/anaerob dextróz fogyasztás,
ureáz, kénhidrogén, Analytical Profile Index (API), stb.

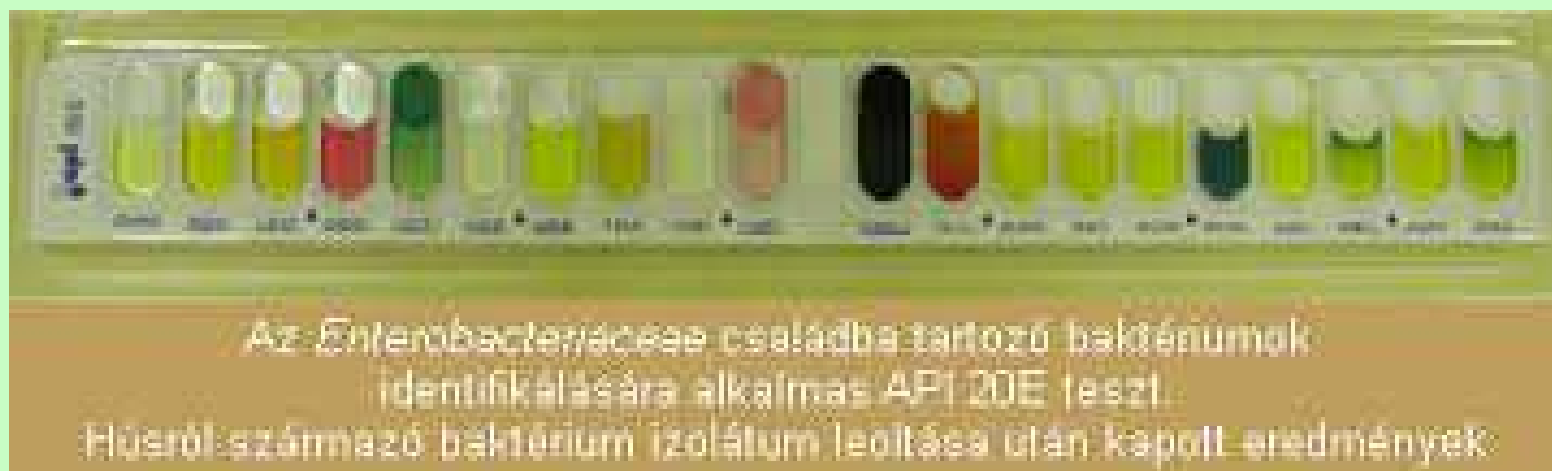

Mikrobiológiai módszerek

Identifikáció:

Analytical Profile Index (API)

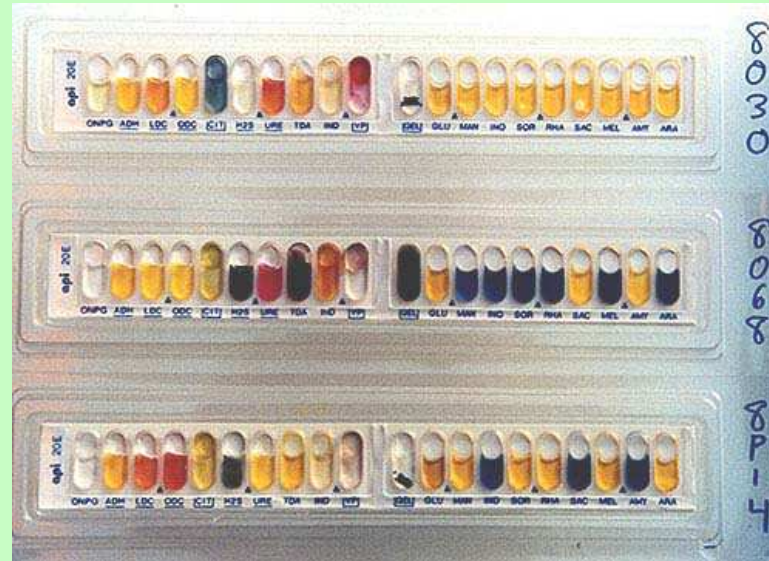

ONPG (β -galactosidase),
ADH (arginine dihydrolase),
LDC (lysine decarboxylase),
ODC (ornithine decarboxylase),
CIT (citrate utilization),
H₂S (sulfide production),
URE (urease),
TDA (tryptophane deaminase),
IND (indole production),
VP (Voges-Proskauer reaction),

GEL (gelatin liquefaction),
GLU (glucose fermentation),
MAN (mannitol fermentation),
INO (inositol fermentation),
SOR (sorbitol fermentation),
RHA (rhamnose fermentation),
SAC (sucrose fermentation),
MEL (melibiose fermentation),
AMY (amygdalin fermentation),
ARA (arabinose fermentation)



Mikrobiológiai módszerek

Identifikáció: Analytical Profile Index (API)

cultu re no.	O N P G	A D H	L D C	O D C	C I T	H 2 S	U R E	T D A	I N D	V P	G E L	G L U	M A N	I N O	S O R	R H A	S A C	M E L	A M Y	A R A
8030	+	-	+	-	+	-	+	-	-	+	-	+	+	+	+	+	+	+	+	+
8068	-	-	-	-	-	+	+	+	+	-	+	+	-	-	-	-	+	-	+	-
8P14	-	-	+	+	-	+	-	-	-	-	-	+	+	-	+	+	-	+	-	+

8030 *Klebsiella pneumoniae*

8068 *Proteus vulgaris*

8P14 *Salmonella sp.*



Mikrobiológiai módszerek

Genetikai identifikáció:
pl. 16S RNS szekvencia alapján

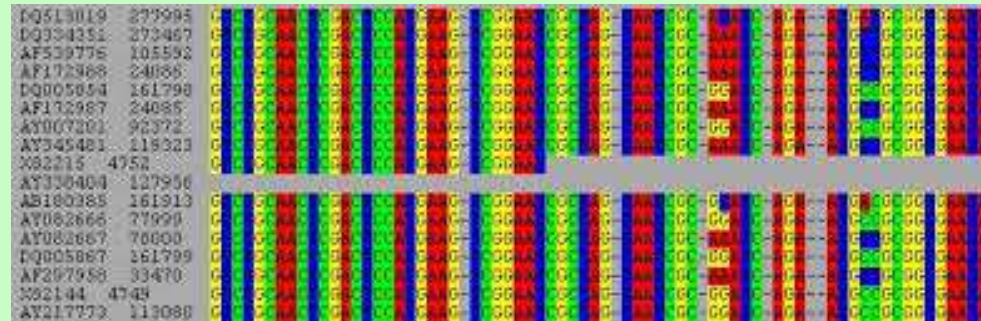
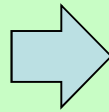
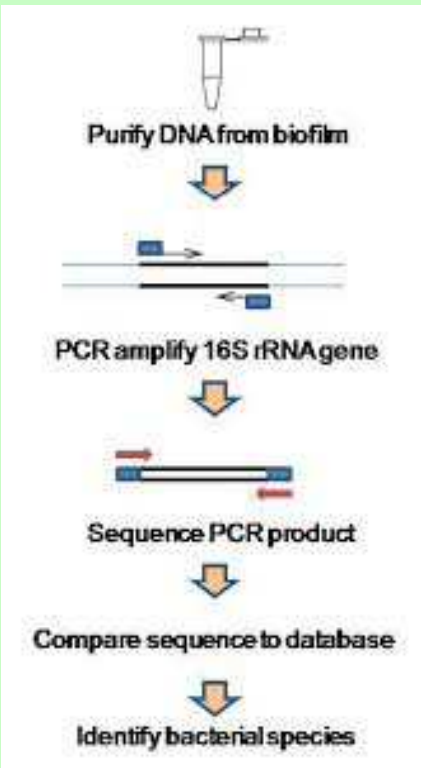
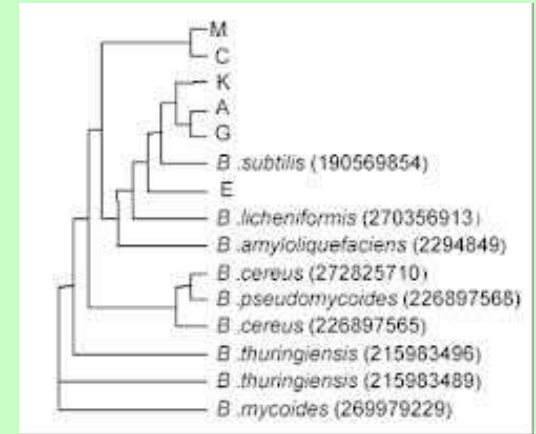

Mikrobiológiai módszerek

Tartósítás fenntartás

-aktív formában:

-szárítva ampullában (liofilezve)

-lelassítva agaron, hűtőben
(időszakos átoltás)

-ferdeagar kémcsőben (+olaj)

-szűrt agar kémcsőben (anaerobok)

-petricsészés agaron

- fagyasztva (-150°C, folyékony nitrogén -193°C)

-inaktív formában: spórák, szaporítóképletek

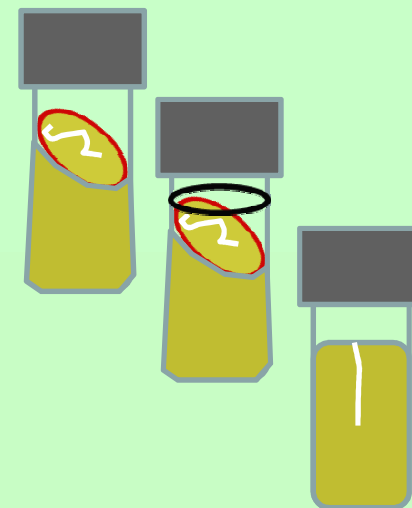

Időszakos átoltás



Liofilezés



Tartósítás mélyhütéses fagyasztással



Mikrobiológiai módszerek

Törzsfejlesztés mutációval

Az élőszervezet képességeit a genomja határozza meg → a fejlesztéshez genomot kell módosítani → mutáció

Fizikai mutagének:

-besugárzás - UV, gamma, Röntgen; dózis (intenzitás x idő)

Kémiai mutagének:

-DNS-t megváltoztató anyagok, dózis (koncentráció x idő)

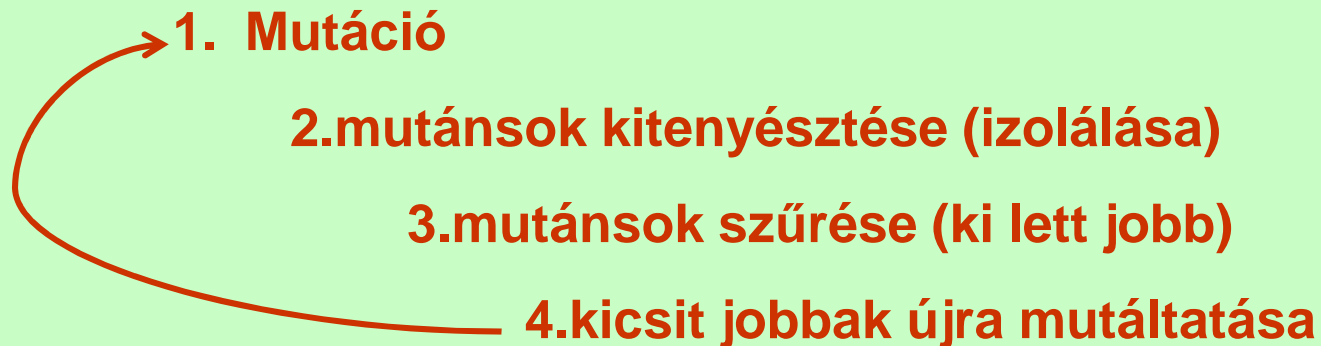

Mikrobiológiai módszerek

Törzsfejlesztés gén manipulációval

Az élőszervezet képességeit a genomja határozza meg → a fejlesztéshez genomot kell módosítani → molekuláris biológiai beavatkozás DNS szinten

Új gén bevitele: plazmidba v. kromoszómába

Meglévő gén átalakítása: deléció, inzerció, site directed mutagenesis, szintetikus gén bevitel

Promóterek befolyásolása: aktiválása (m-RNS szintézis növelése)
elnyomása (m-RNS szintézis csökkentése)

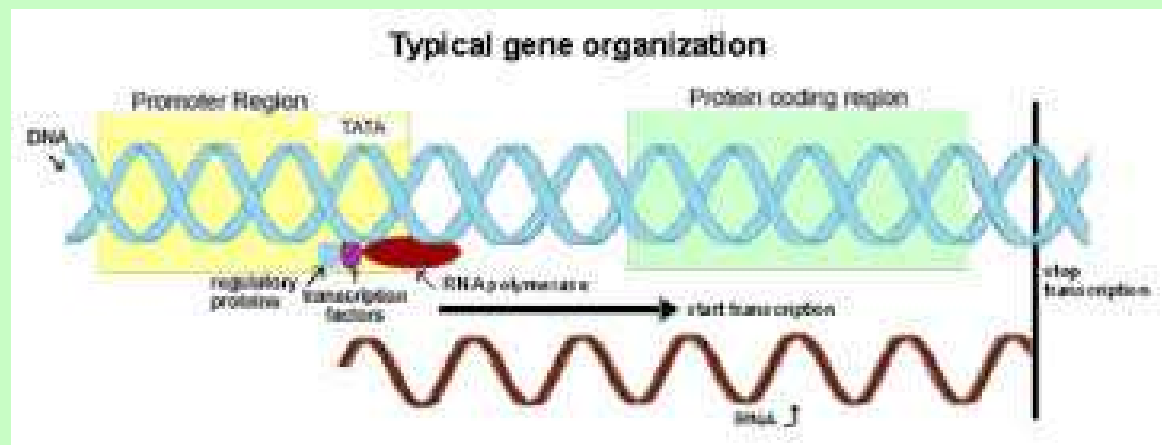

Mikrobiológiai módszerek: Összefoglalás

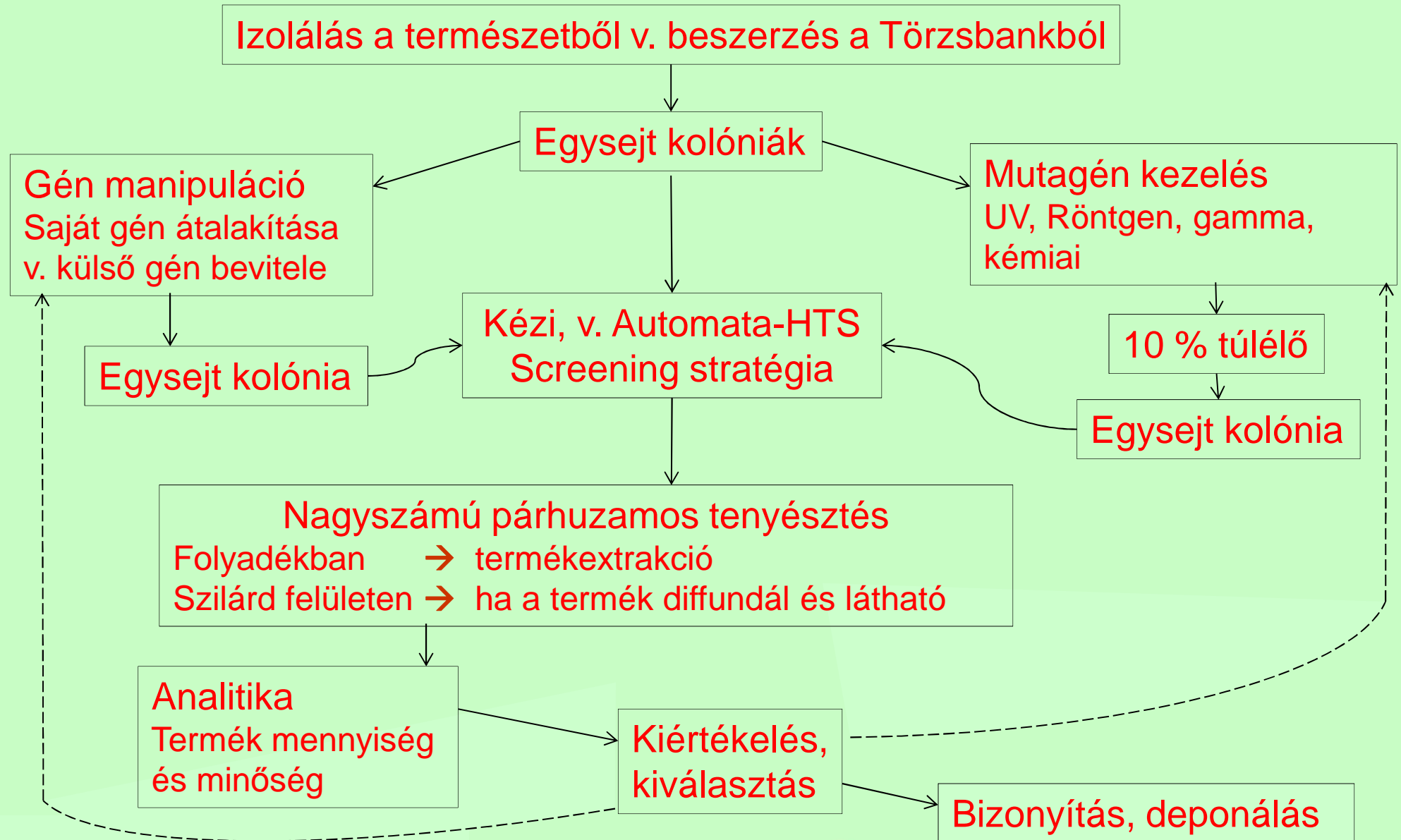

Általános felszerelések egy mikrobiológiai laboratóriumban

- Sterilfülke
- Tápoldatok
- Tenyésztőedények
- Hűtők
- Folyékony nitrogén
- Centrifugák
- Termosztát
- Kacs, szélesztő bot
- Pipetta
- Autokláv
- Hőlégenderilező
- Fagyasztókapszula
- Mikroszkóp
- ELISA-reader



CO₂ termosztát emlős sejt tenyésztéshez

37°C

5% CO₂

100% páratartalom



Steril munkavégzés

**HEPA (high efficiency particulate air)filter
99.99%-ban kiszűri a
levegőből a 0.2 mikron
méretű részecskéket.**

**A szűrt levegőt a rendszer
folyamatosan áramoltatja
a munkafelületen.**

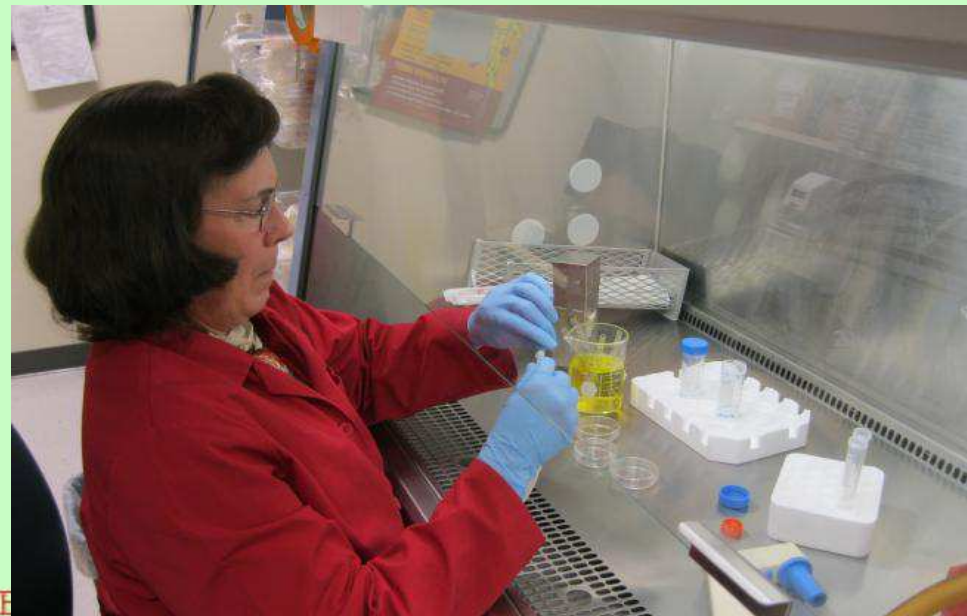
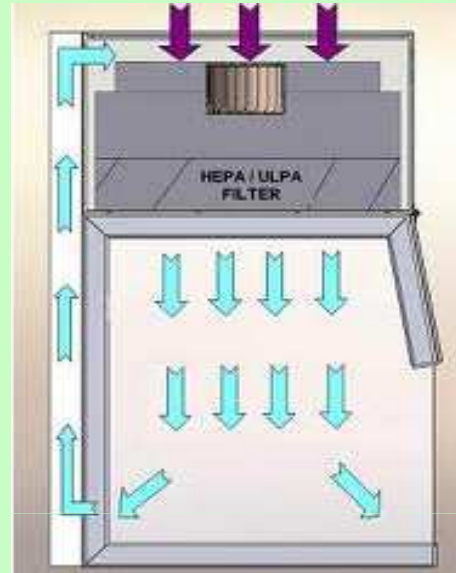

Tenyésztőedények baktériumokhoz, élesztőkhöz, gombákhoz

Petri-csészék



Flaskák



Tenyésztőedények emlős sejtekhez

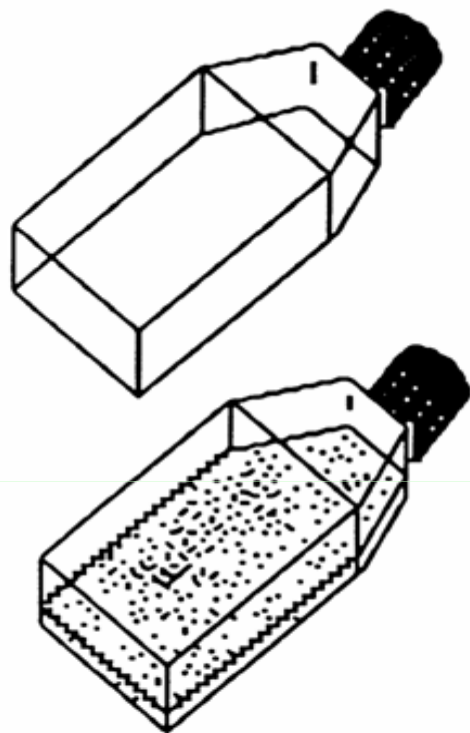

T- flasks

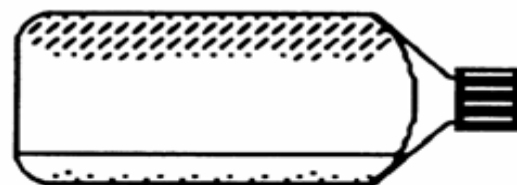

Side view

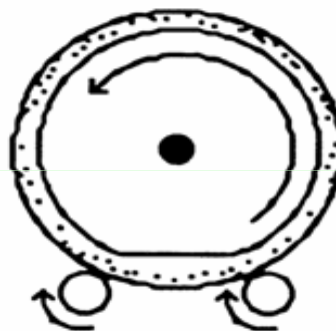

View from bottom

Roller bottle

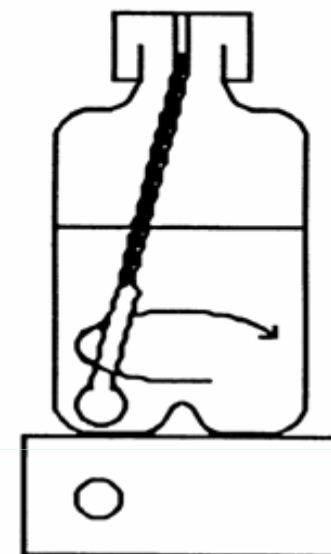

Spinner bottle



Tenyésztőedények emlős sejtekhez



- **Petri-csészék**
- **Többllyukú lemezek (plate)**
- **Flaskák**



Mikroszkóp

A sejtek növekedésének vizsgálata

A sejszerkezet vizsgálata

A sejt életképesség vizsgálata

Fertőzések kiszűrése

Sejtszámolás

Festési eljárások

Transzfekció ellenőrzése

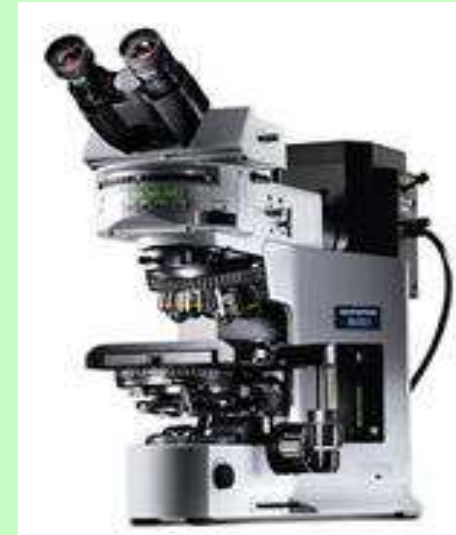

Mikroszkóp

Anton van Leeuwenhoek (1632-1723)

Elsőként észlelt szabad szemmel nem látható képleteket és élőlényeket
kb.1674

Az általa elért nagyítás 300X

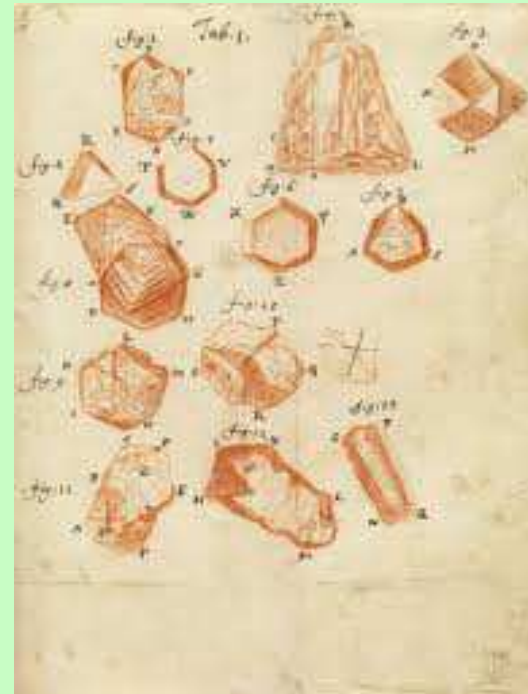
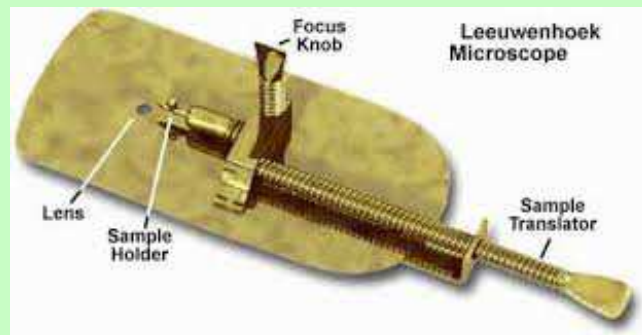

Fénymikroszkóp

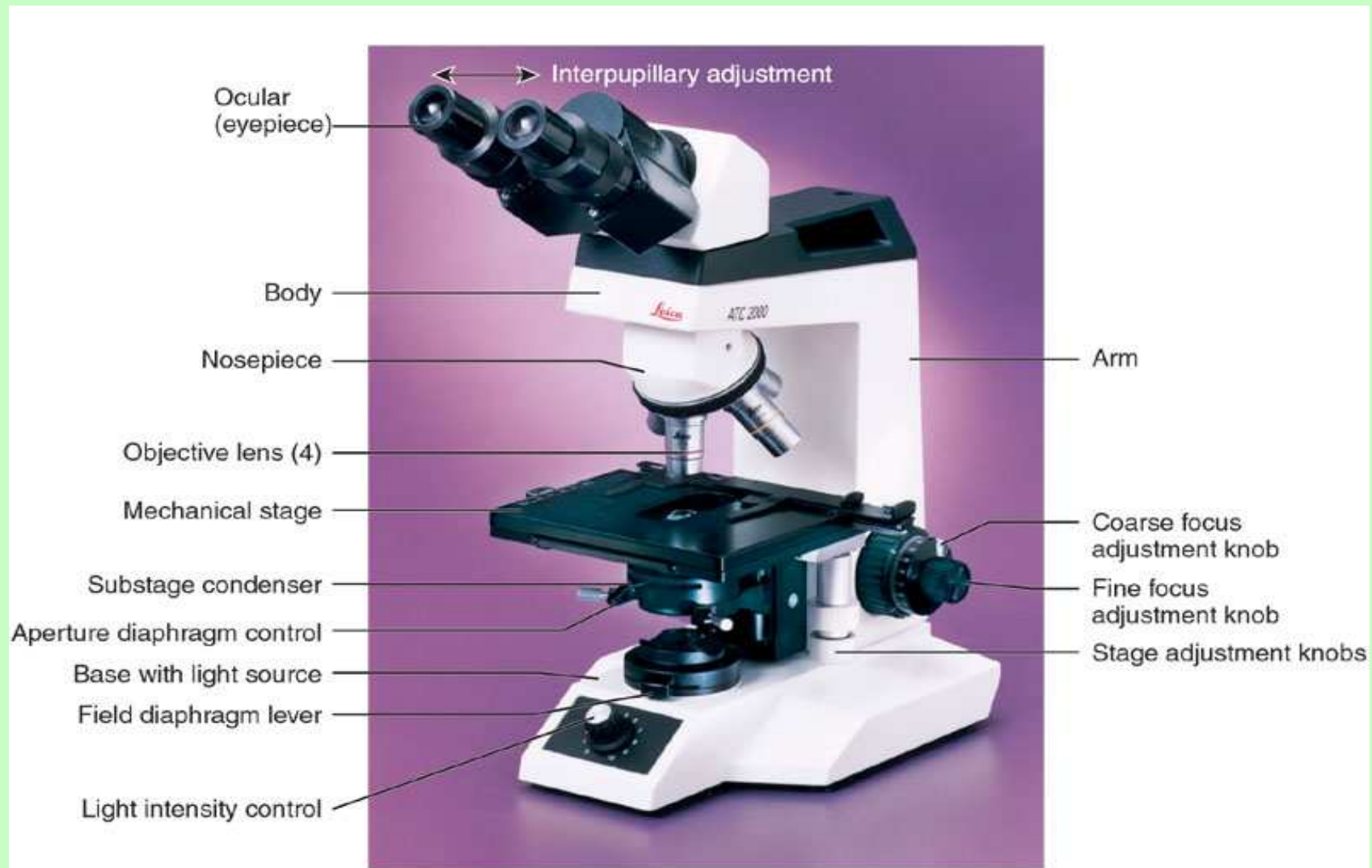

A fény útja

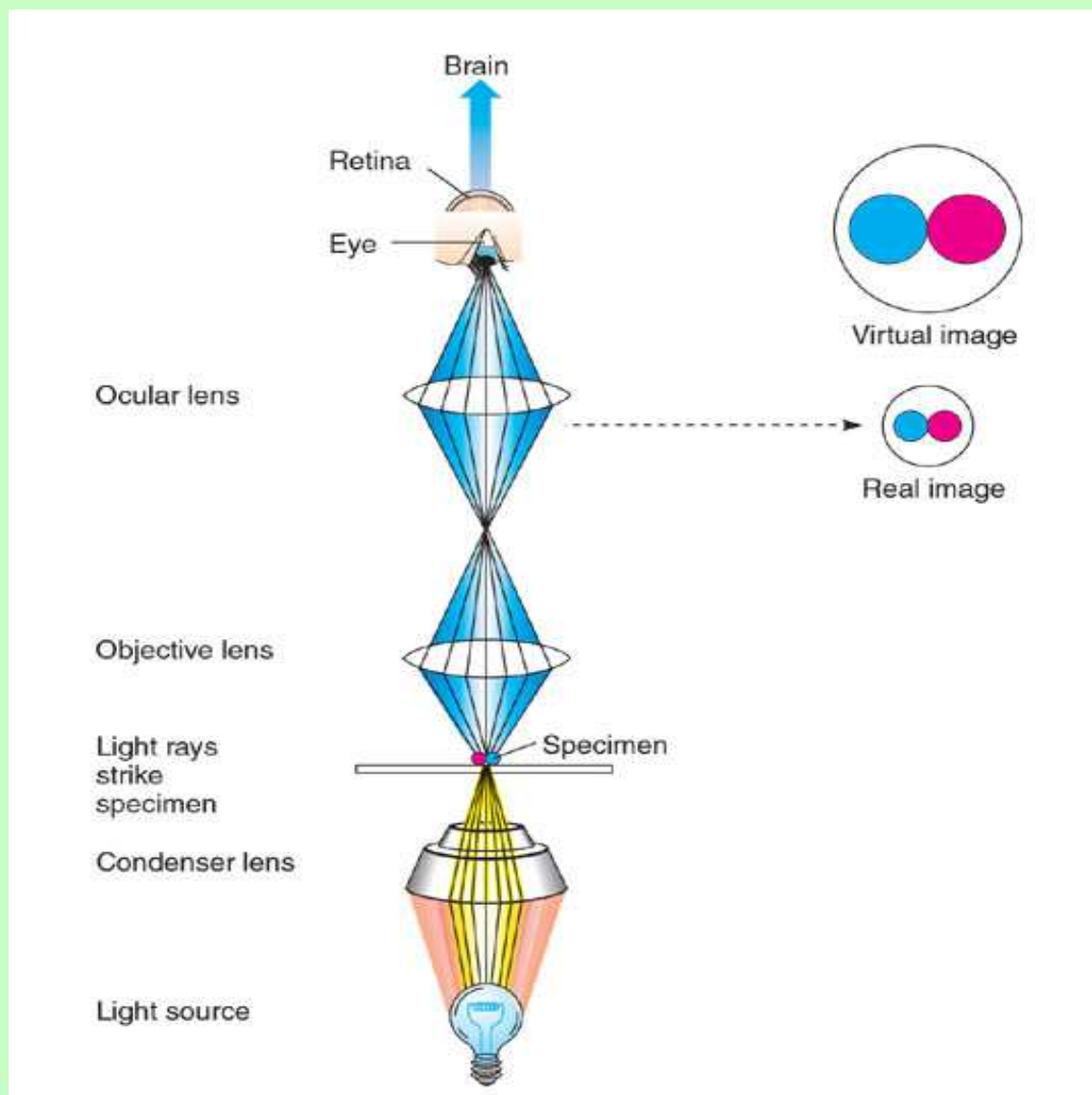

A hullámhossz hatása a felbontásra

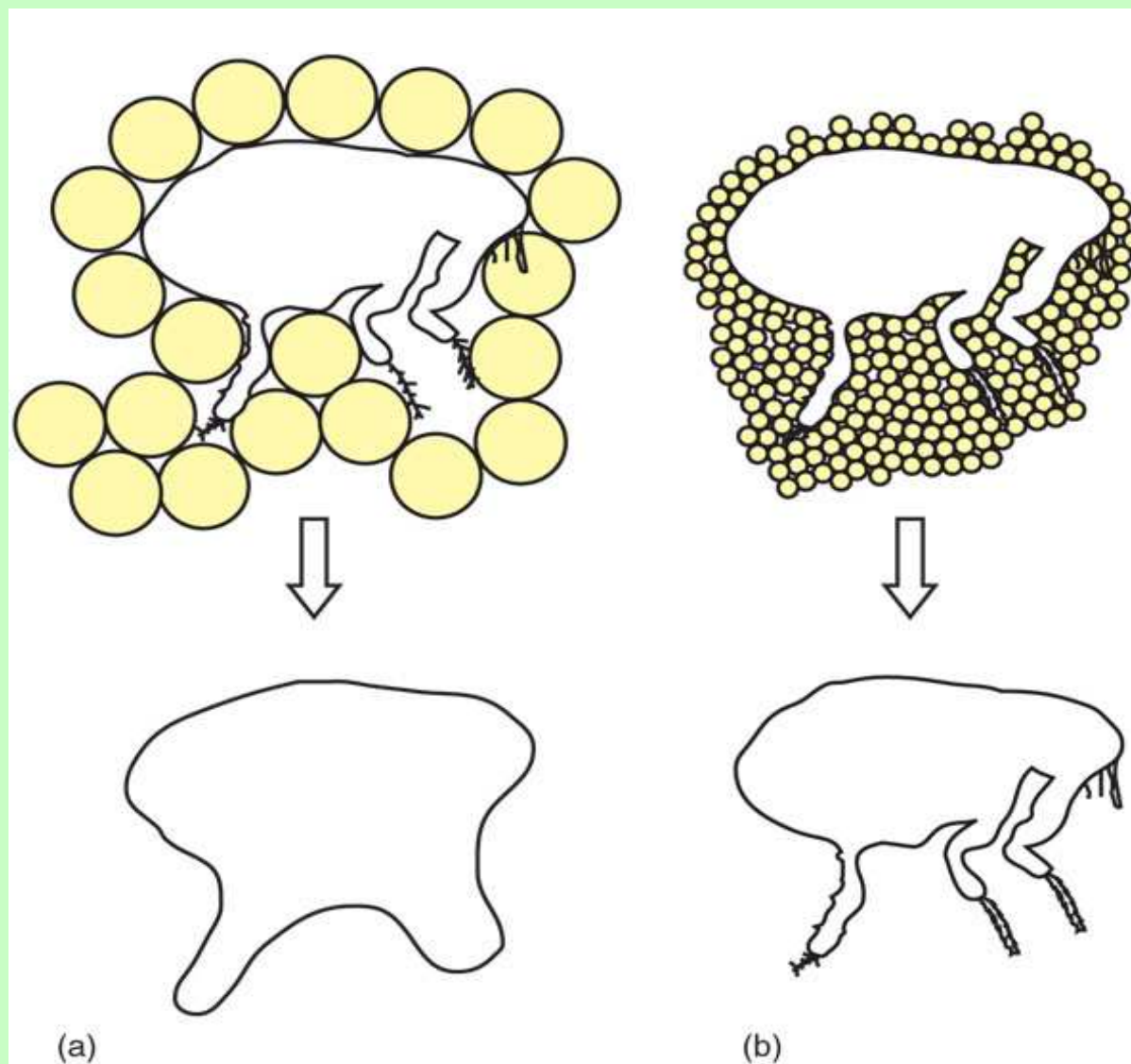

Olaj immerziós lencse

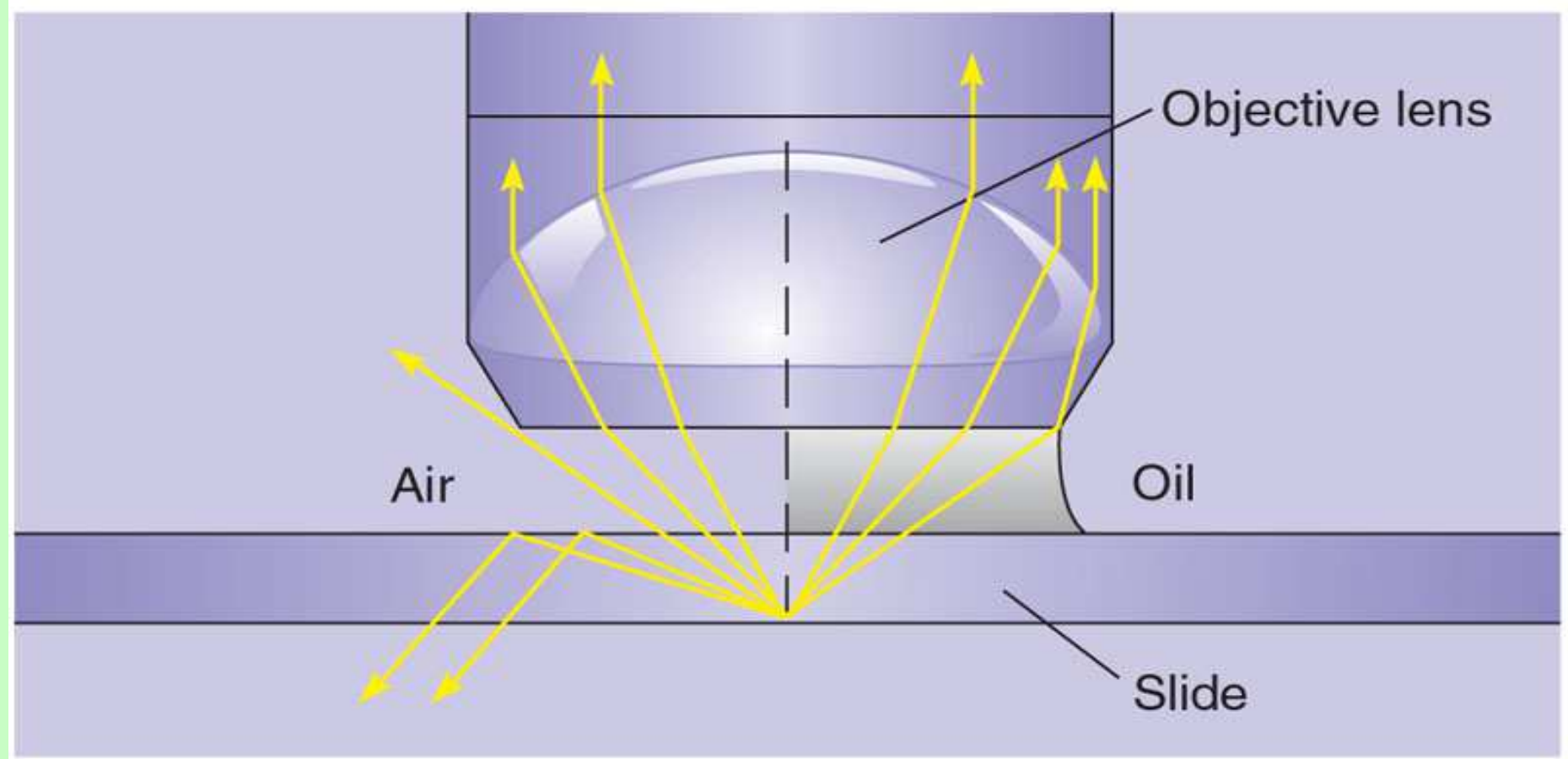

Effect of magnification

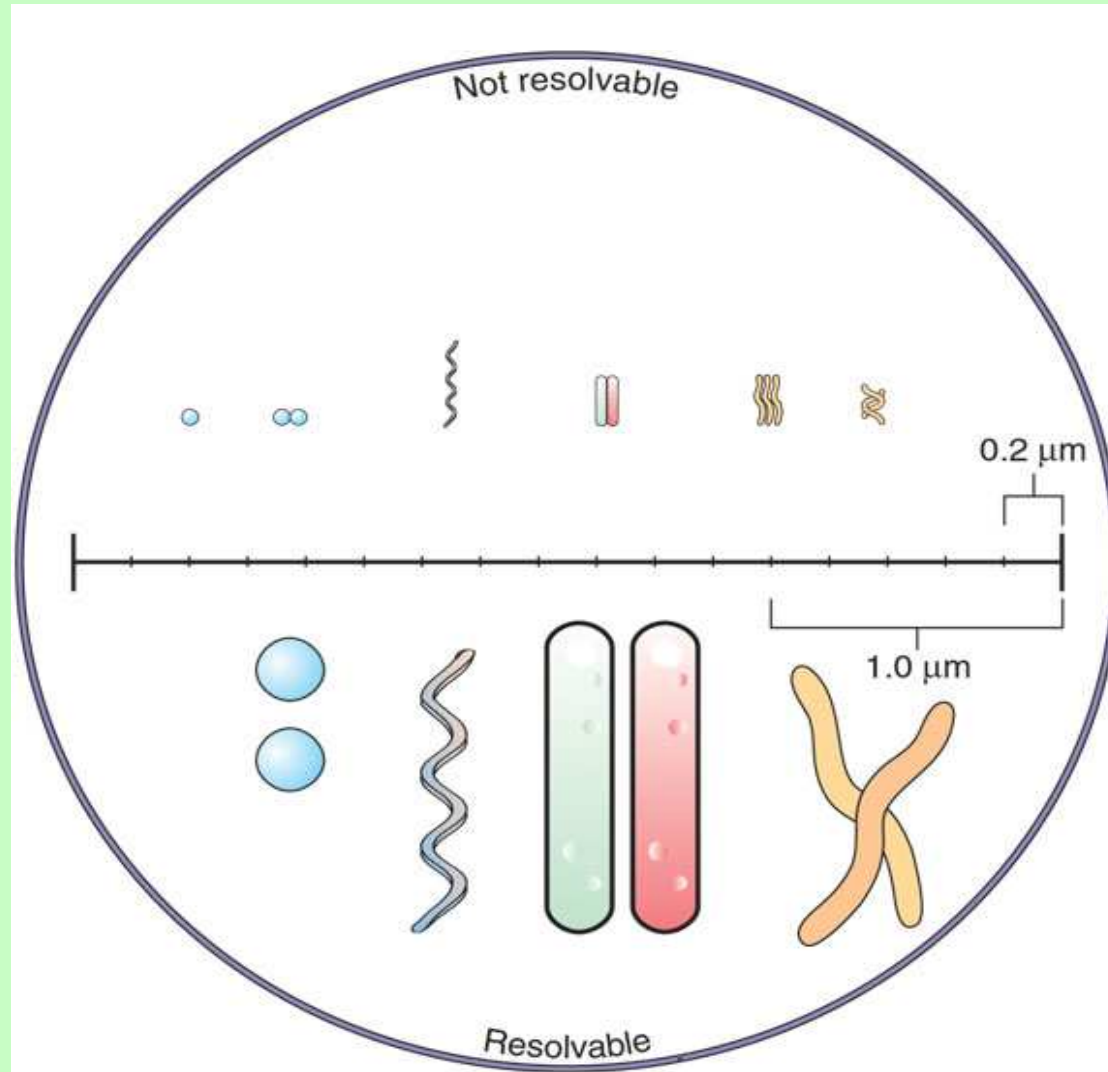

Types of light microscopes



(a)

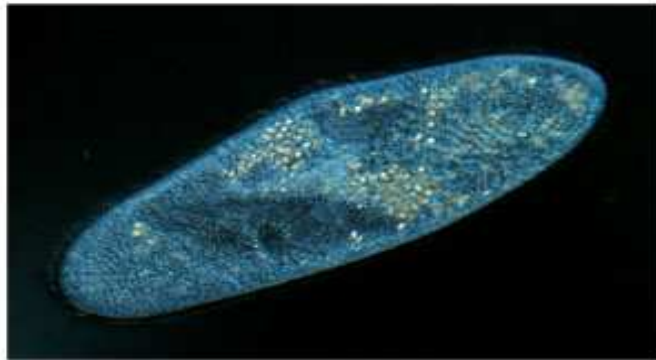

(b)



(c)

Bright-field – most widely used, specimen is darker than surrounding field

Dark-field – brightly illuminated specimens surrounded by dark field

Phase-contrast – transforms subtle changes in light waves passing through the specimen into differences in light intensity, best for observing intracellular structures



Sötétlátóterű mikroszkóp



(a)

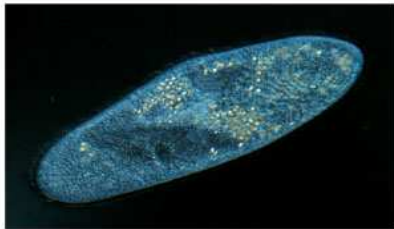

(b)

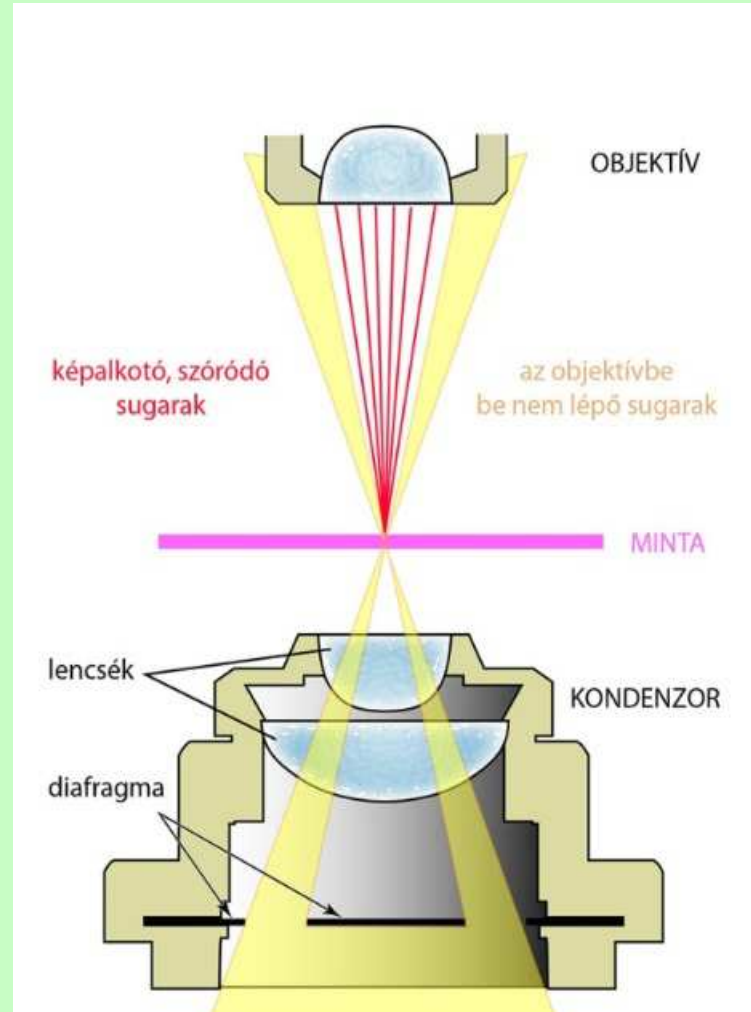

A sötét látóterű mikroszkóp működésének alapja:

a kondenzor speciális rekesze (diafragmája) azokat a sugarakat szűri ki, amelyek az objektívbe jutnának, így csak a tárgy pontjain szóródó fénysugarak vesznek részt a kép kialakításában



A fáziskontraszt mikroszkóp működési elve

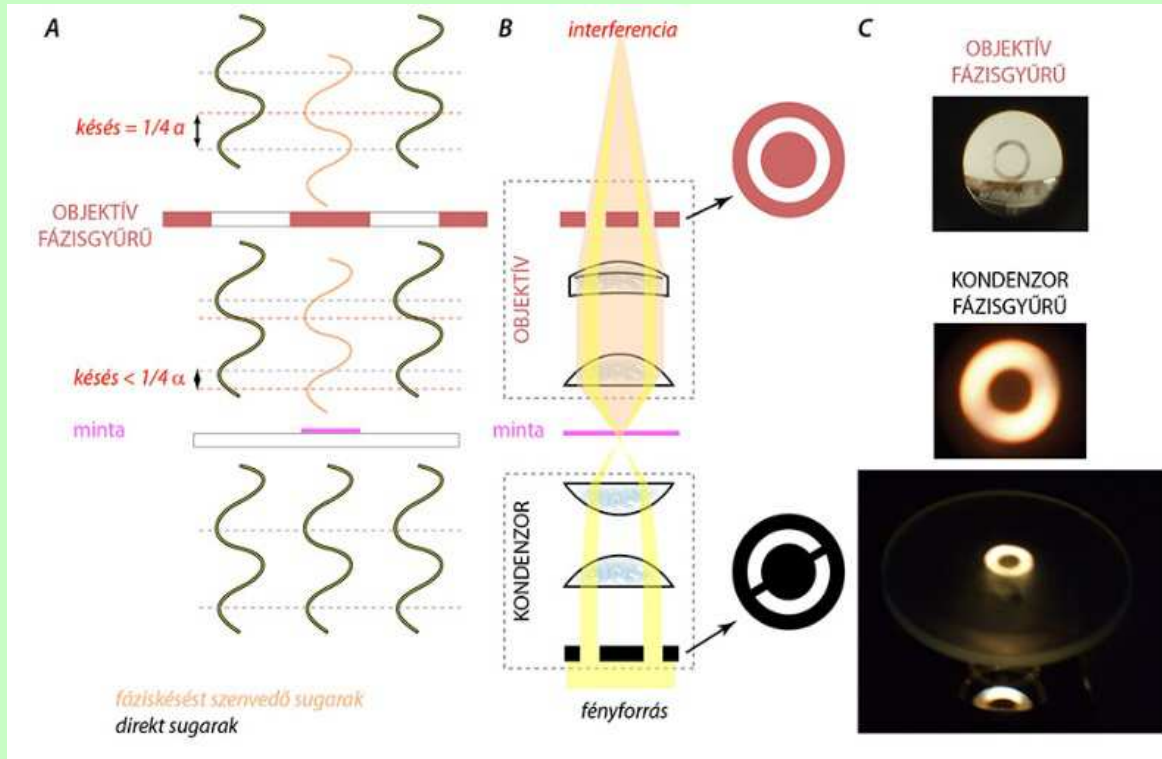

Egyes, a fényforrásból a kondenzoron át érkező sugarak a mintán fáziskésést szenvednek, amit az objektív gyűrűdiafragmája megnövel (A); a késést nem szenvedő és az adott hullámhosszal késő sugarakat az objektív fókuszálja: itt a fellépő interferencia következtében a találkozó hullámok vagy kioltják, vagy erősítik egymást (kontraszt alakul ki) (B); A gyűrűdiafragmák felülnézeti képe rajzon és a valóságban (C)



Fáziskontraszt mikroszkóp

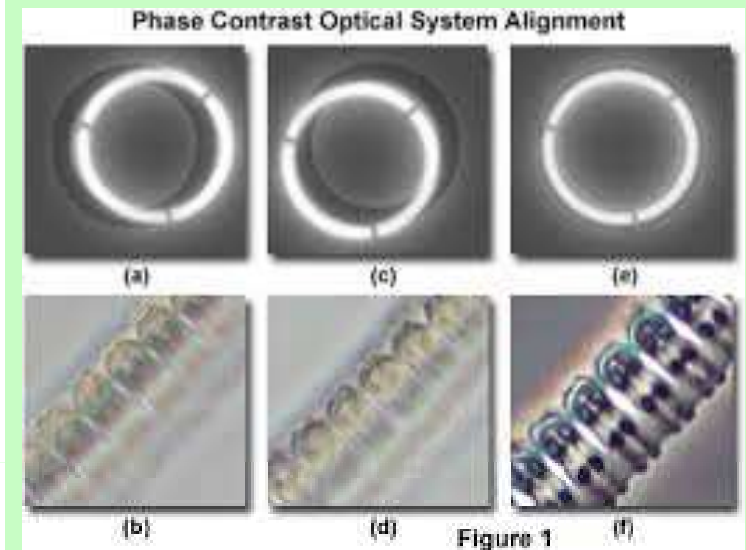
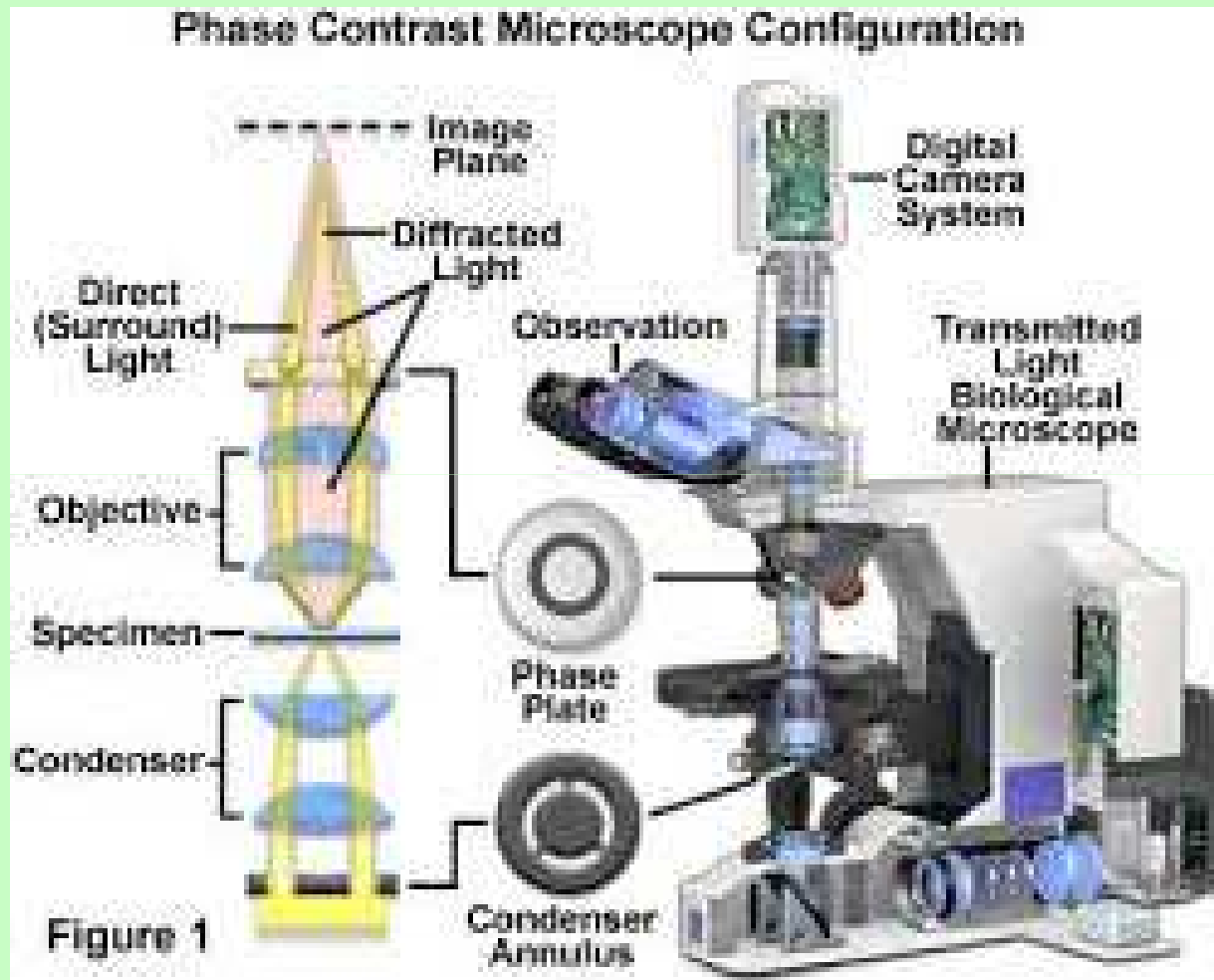

Fluorescence Microscope

Modified compound microscope with an ultraviolet radiation source and a filter that protects the viewer's eye

Uses dyes that emit visible light when bombarded with shorter uv rays.

Useful in diagnosing infections

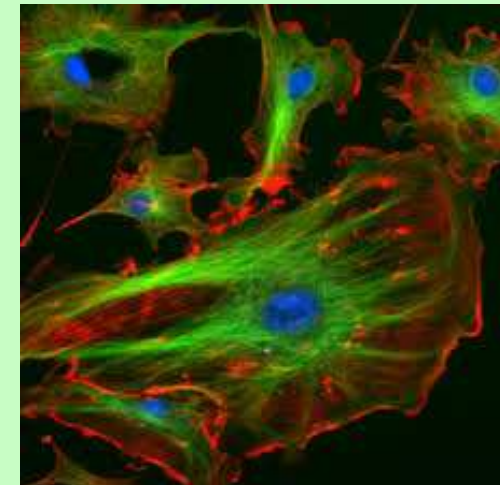
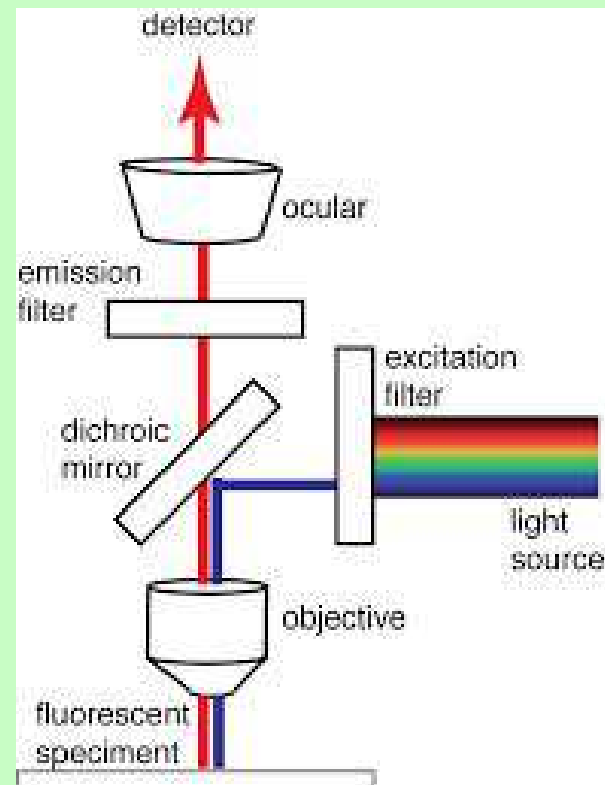
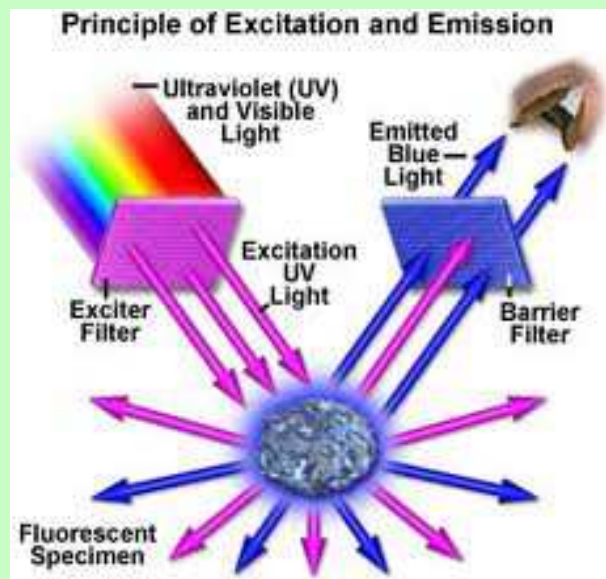

Fluorescence Microscope



Fluoreszcens festékek

- **Hoechst 33342:kék**
 - szelektív nukleáris festék
 - kromatin kondenzáció, fragmentáció
- **Bis-L-aszpartát amid (caspase 3 szubsztrát): zöld**
- **TMRE: mitokondrium polarizáció : piros**

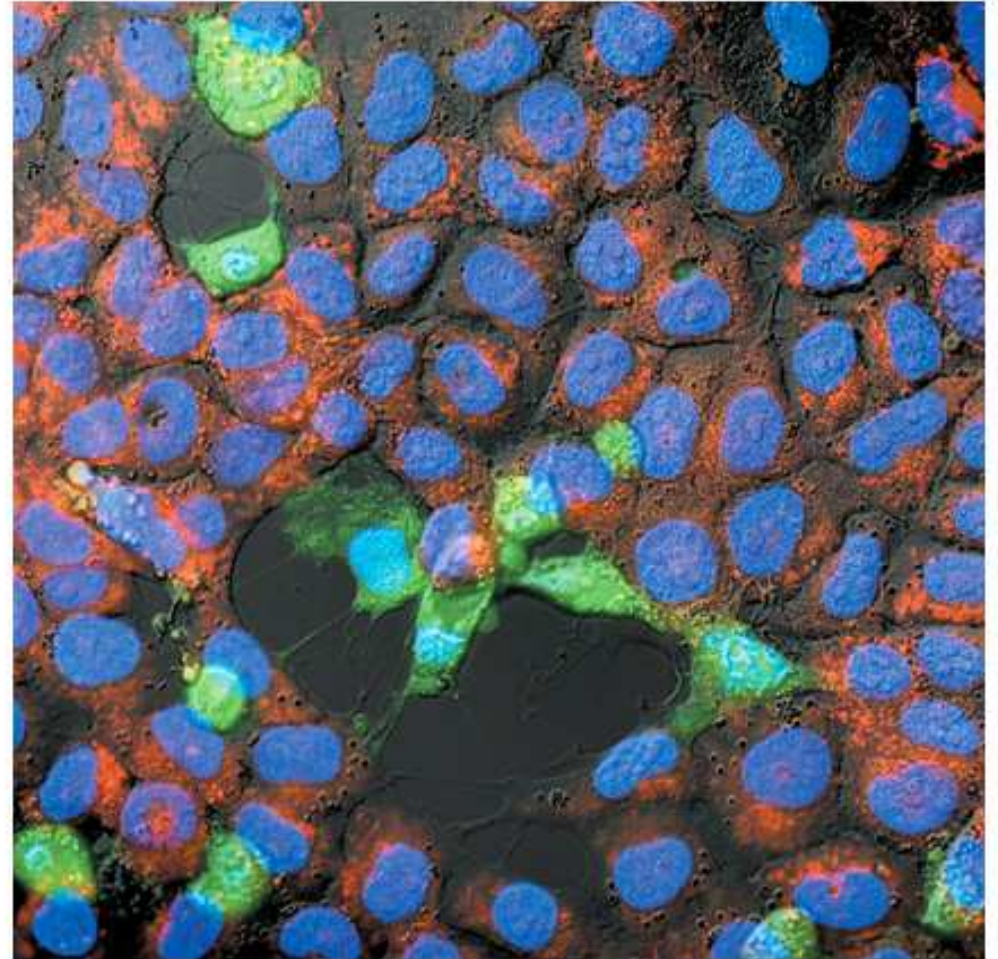

Konfokális mikroszkóp

A konfokális mikroszkóp fluoreszcensen jelölt minták vizsgálatára alkalmas. A hagyományos mikroszkópokkal szemben, ahol a minta egy területét éri a megvilágítás, a konfokális mikroszkópnál egyszerre csak a minta egy pontját világítják meg, így a konfokális elrendezés önmagában nem ad képet. A pásztázó nyaláb végig megy a vizsgálandó felületen (beam scanning), épp úgy, ahogy az elektronsugár a tévéképernyőn.

A detektor minden egyes pontban megméri a fény intenzitását. A kapott digitális kép számítógéppel kezelhető és elemezhető. Több szelet képét összerakva a fluorofór térbeli elhelyezkedése is vizsgálható.

A konfokális képalkotás lényege, hogy a rendszer csak a fókuszsíkból jövő fényt detektálja.

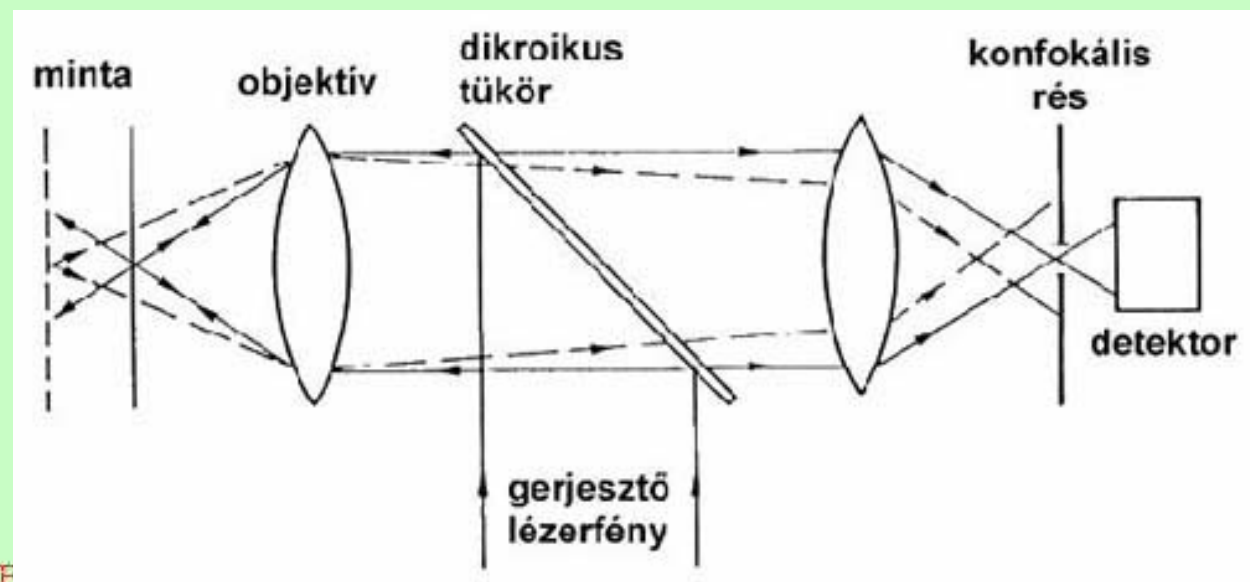

Konfokális mikroszkóp

Fundamental Set-up of Fluorescence Microscopes: confocal vs. widefield

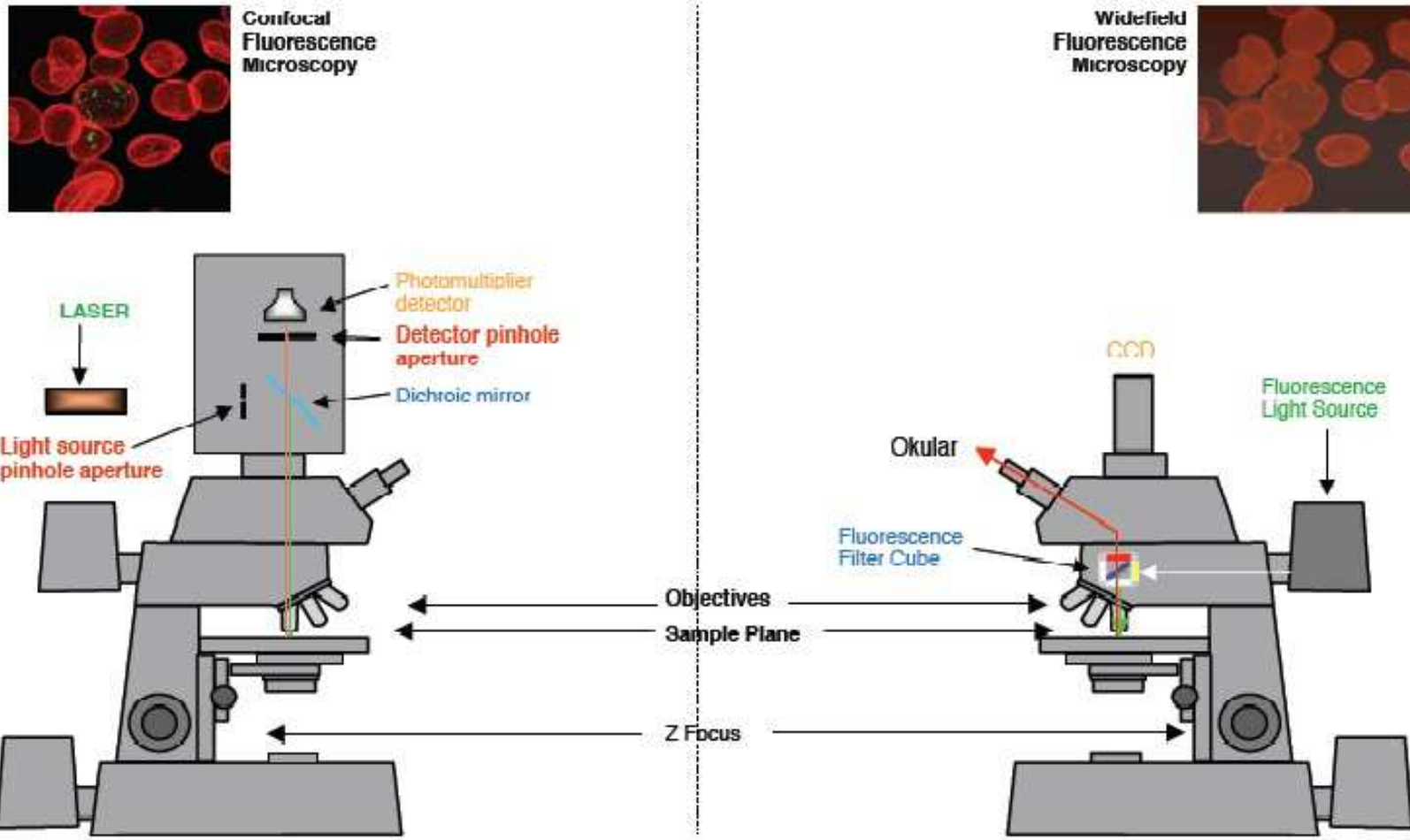

Electron microscopy

Forms an image with a beam of electrons that can be made to travel in wavelike patterns when accelerated to high speeds.

Electron waves are 100,000X shorter than the waves of visible light.

Electrons have tremendous power to resolve minute structures because resolving power is a function of wavelength.

Magnification between 5,000X and 1,000,000X



Electron microscopy

Two types

Transmission electron microscopes (TEM)

Scanning electron microscopes (SEM)

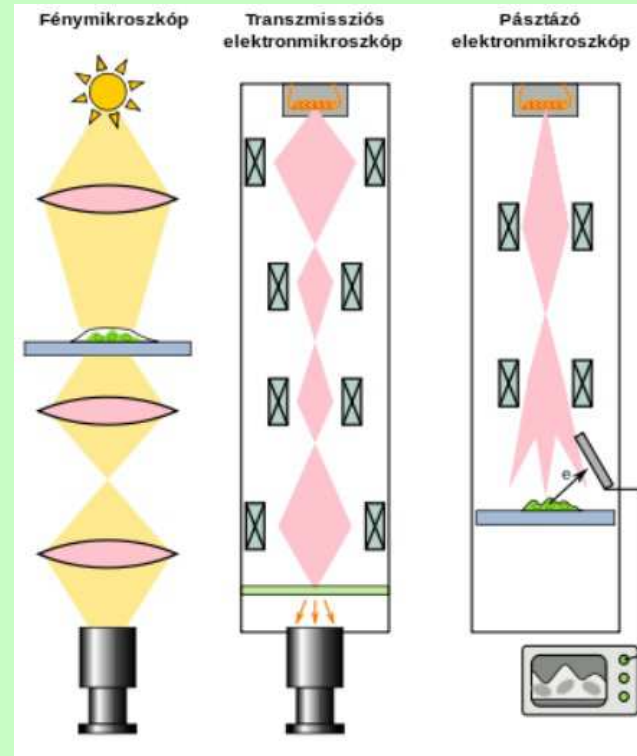

Scanning EM image of HIV budding from the cell surface of a lymphocyte (arrow). Bar, 100 nm. Magnification, $\times 50,000$.

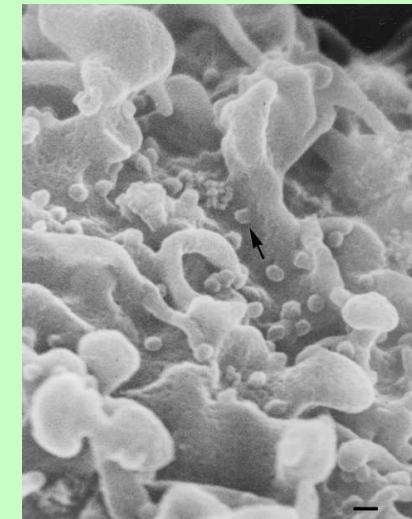

Transmission Electron Micrograph

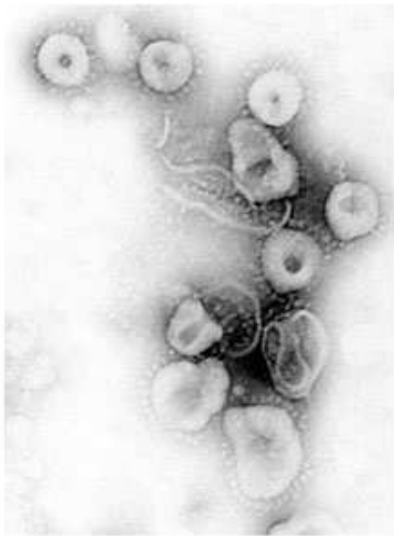

(a)

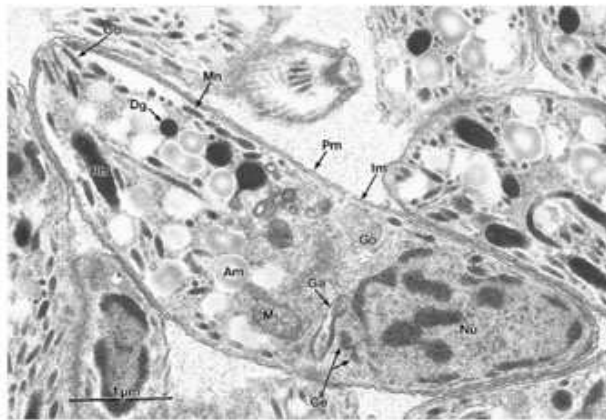

(b)

TEM involves a high voltage electron beam emitted by a cathode. The electron beam that has been partially transmitted through the very thin (and so semitransparent for electrons) specimen carries information about the structure of the specimen. The "image" is then magnified by a series of magnetic lenses until it is recorded by hitting a fluorescent screen, photographic plate, or light sensitive sensor such as a CCD (charge-coupled device) camera. Darker areas represent thicker, denser parts and lighter areas indicate more transparent, less dense parts



Scanning Electron Micrograph

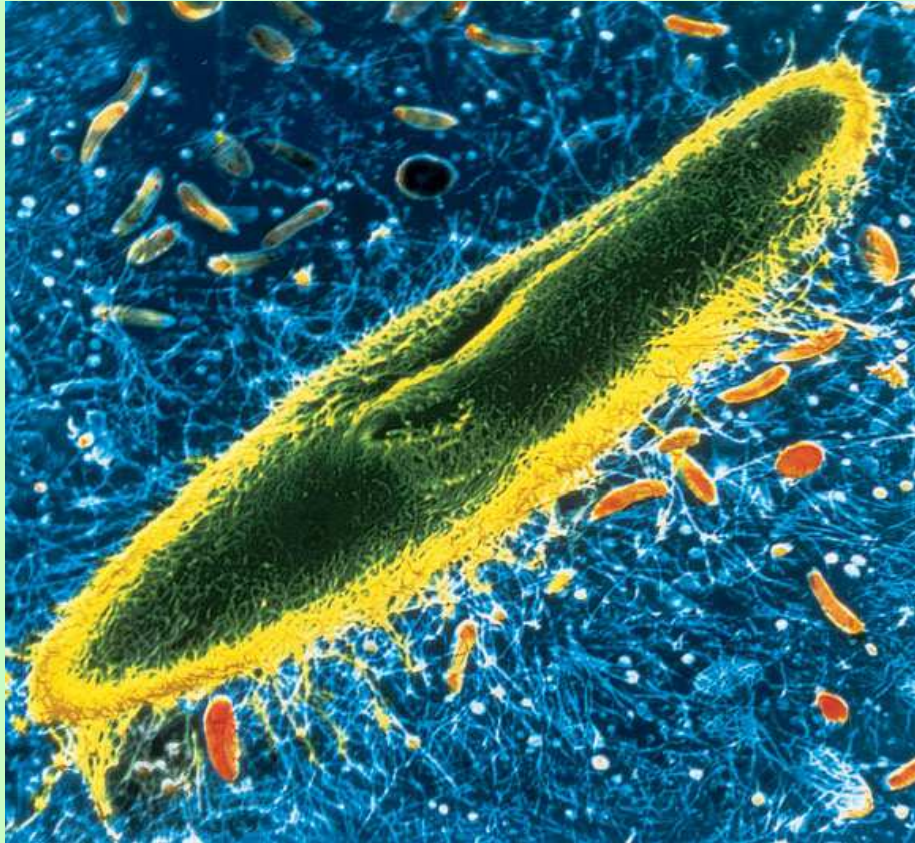

SEM – provides detailed three-dimensional view. SEM bombards surface of a whole, metal-coated specimen with electrons while scanning back and forth over it. Unlike the TEM, where the electrons in the primary beam are transmitted through the sample, the Scanning Electron Microscope (SEM) produces images by detecting secondary electrons which are emitted from the surface due to excitation by the primary electron beam.

In the SEM, the electron beam is scanned across the surface of the sample in a raster pattern, with detectors building up an image by mapping the detected signals with beam position.



Sejtszámolás és életképesség vizsgálat

Mikroba mérés:

1. OD-optical density (UV-Vis photometer, 600-660nm)
2. Turbidimetria (online)
3. Mikroszkóp – sejtszámlálás Bürker kamrával (10^6 db/ml)
4. Cellcounter (10^6 db/ml)
5. Sejt Szárazanyag (1-10 g/L)
6. Hígításos szélesztéses módszer (CFU/ml)



Sejtszámolás és életképesség vizsgálat

A sejtekkel végzett munka napi rutin része a sejtek számlálása és életképességüknek vizsgálata. Tripánkék festékkel, Bürker vagy Neubauer kamra segítségével szokták végezni.

